



US00D625639S

(12) **United States Design Patent**
Kamata

(10) **Patent No.:** **US D625,639 S**
(45) **Date of Patent:** **** Oct. 19, 2010**

(54) **WATCH DIAL**
(75) Inventor: **Junichi Kamata**, Tokyo (JP)
(73) Assignee: **Seiko Watch Kabushiki Kaisha** (JP)
(**) Term: **14 Years**
(21) Appl. No.: **29/333,264**
(22) Filed: **Mar. 5, 2009**

7,215,602 B2 * 5/2007 Hirano et al. 368/28
D548,622 S * 8/2007 Salemi D10/32
D549,598 S * 8/2007 Yoshikawa D10/32
D562,716 S * 2/2008 Kume D10/126
D569,276 S * 5/2008 Scheufele D10/39
D574,734 S * 8/2008 Loth D10/38
D584,171 S * 1/2009 Monachon D10/32
D591,179 S * 4/2009 Loth D10/39
D598,801 S * 8/2009 Behling D10/126

(30) **Foreign Application Priority Data**
Jan. 8, 2009 (JP) 2009-000283
(51) **LOC (9) Cl.** **10-07**
(52) **U.S. Cl.** **D10/126**
(58) **Field of Classification Search** D10/30-39,
D10/122-126; 368/80, 223, 228, 232, 28
See application file for complete search history.

* cited by examiner

Primary Examiner—Lucy Lieberman
(74) *Attorney, Agent, or Firm*—Saidman DesignLaw Group

(56) **References Cited**

U.S. PATENT DOCUMENTS

D323,784 S * 2/1992 Gueit D10/32
5,339,293 A * 8/1994 Kamiyama et al. 368/21
D430,042 S * 8/2000 Schopfer D10/32
D430,043 S * 8/2000 Schopfer D10/39
D444,078 S * 6/2001 Strasser D10/39
D452,175 S * 12/2001 Finazzi D10/39
D488,077 S * 4/2004 Bitetto D10/39
D507,499 S * 7/2005 Bulgari D10/32
D521,879 S * 5/2006 Tonohori D10/31
D525,537 S * 7/2006 Monachon D10/32
D531,536 S * 11/2006 Lovegrove D10/126
D536,996 S * 2/2007 Loth D10/32

(57) **CLAIM**

The ornamental design for a watch dial, as shown and described.

DESCRIPTION

FIG. 1 is a perspective view of a watch dial;
FIG. 2 is a front view thereof;
FIG. 3 is a rear view thereof;
FIG. 4 is a left side view thereof;
FIG. 5 is a right side view thereof;
FIG. 6 is a top plan view thereof; and,
FIG. 7 is a bottom plan view thereof.

The broken lines showing on the drawing disclosure are for illustrative purposes only and form no part of the claimed design.

1 Claim, 4 Drawing Sheets

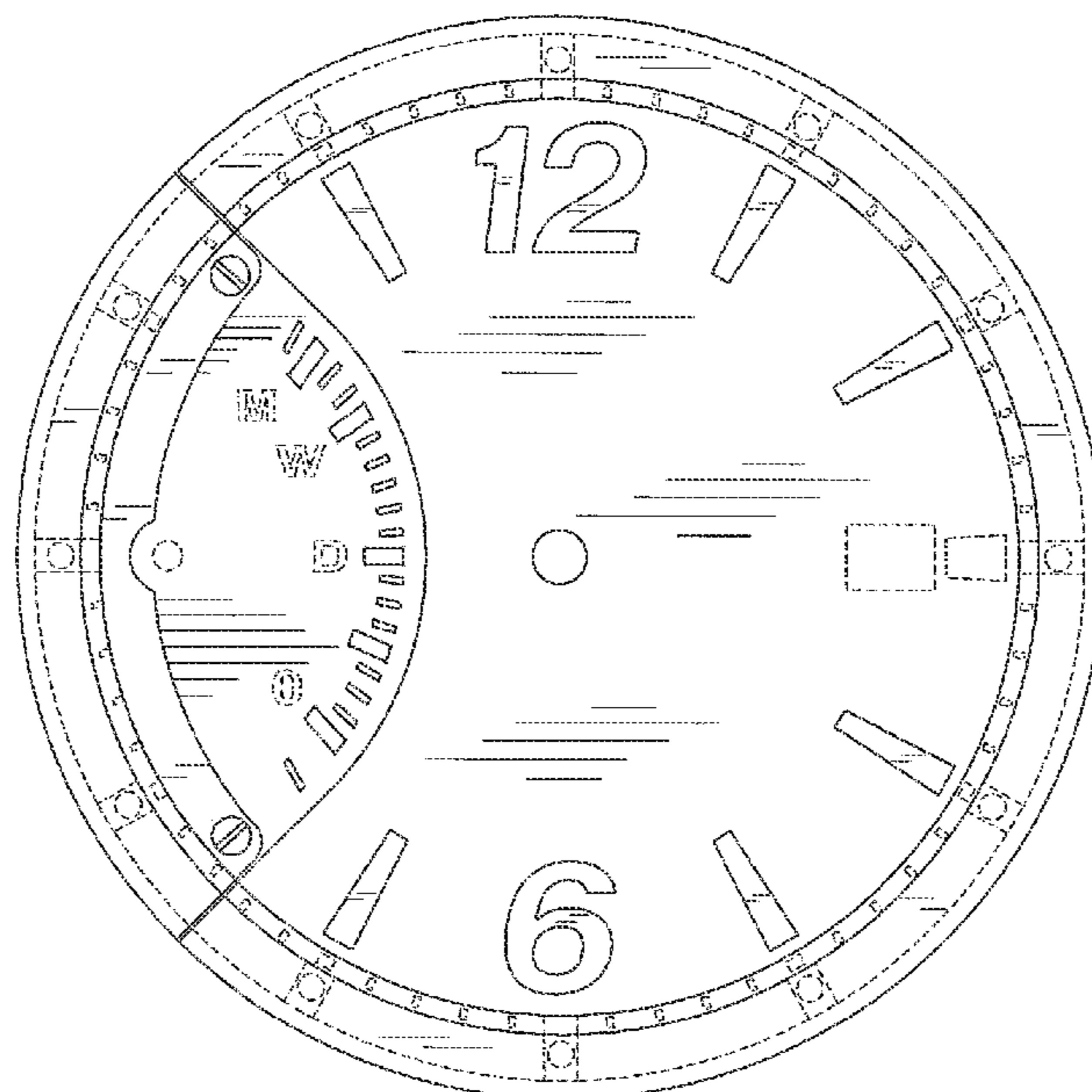

Fig.1

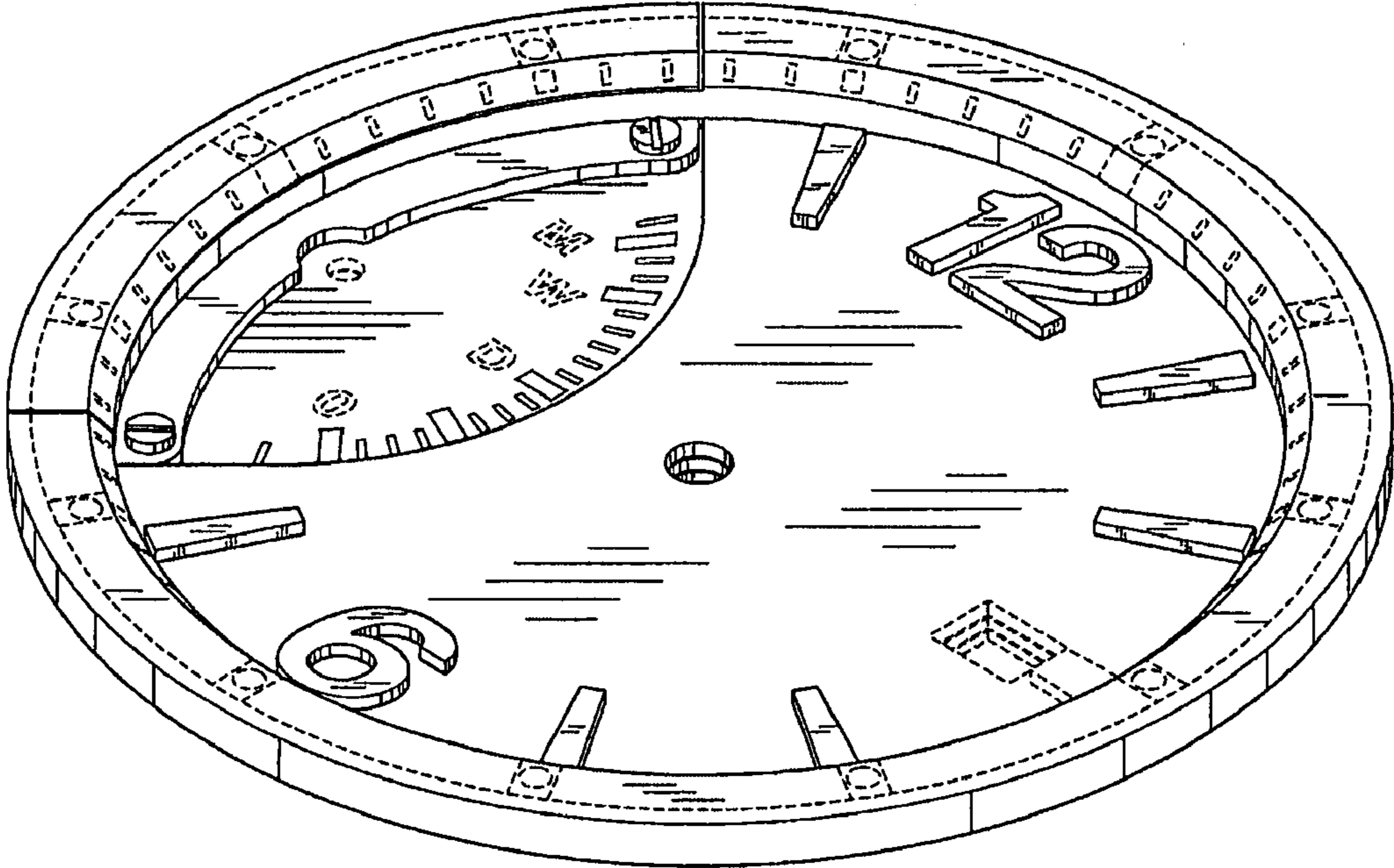

Fig.2

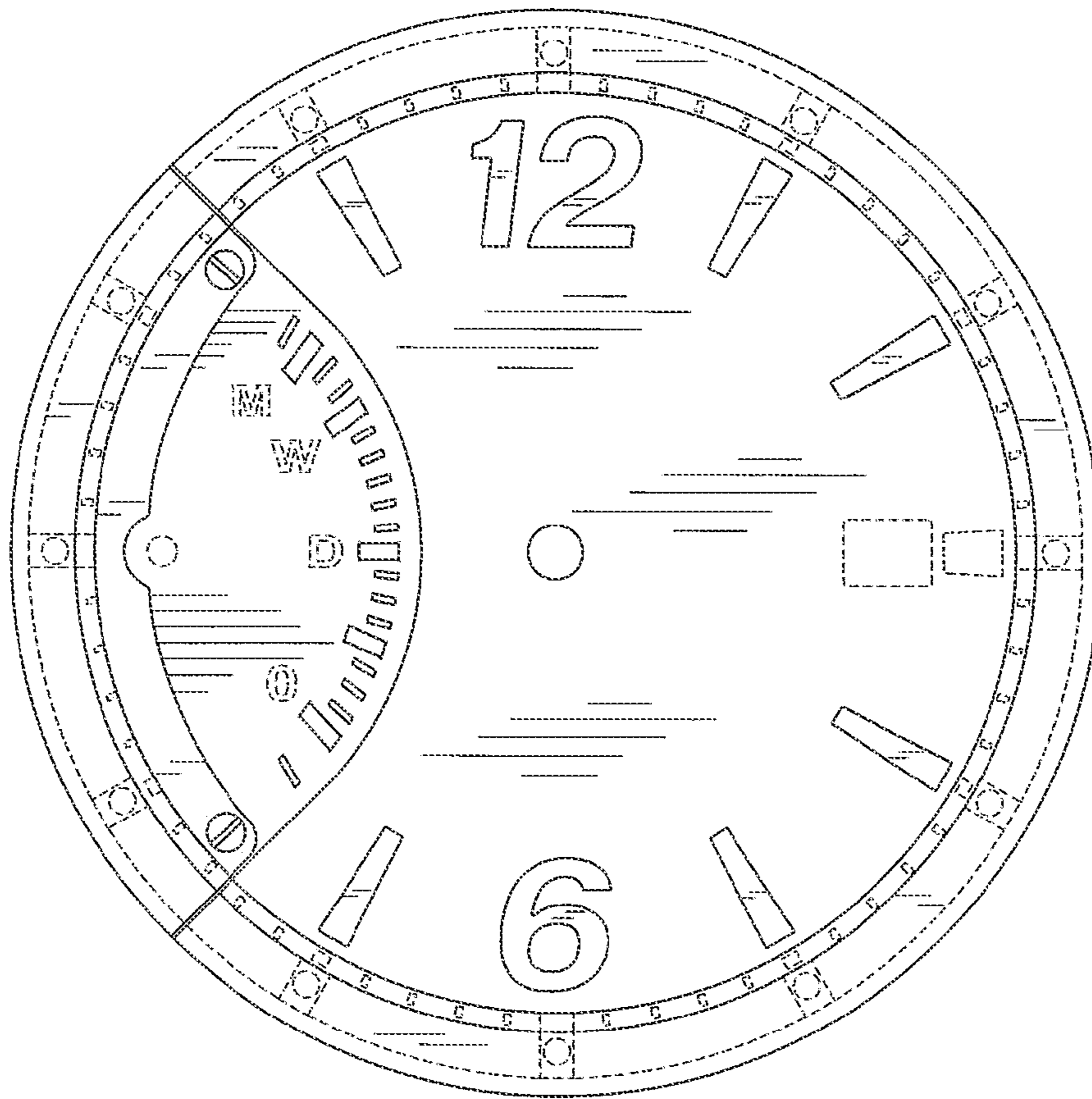

Fig.3

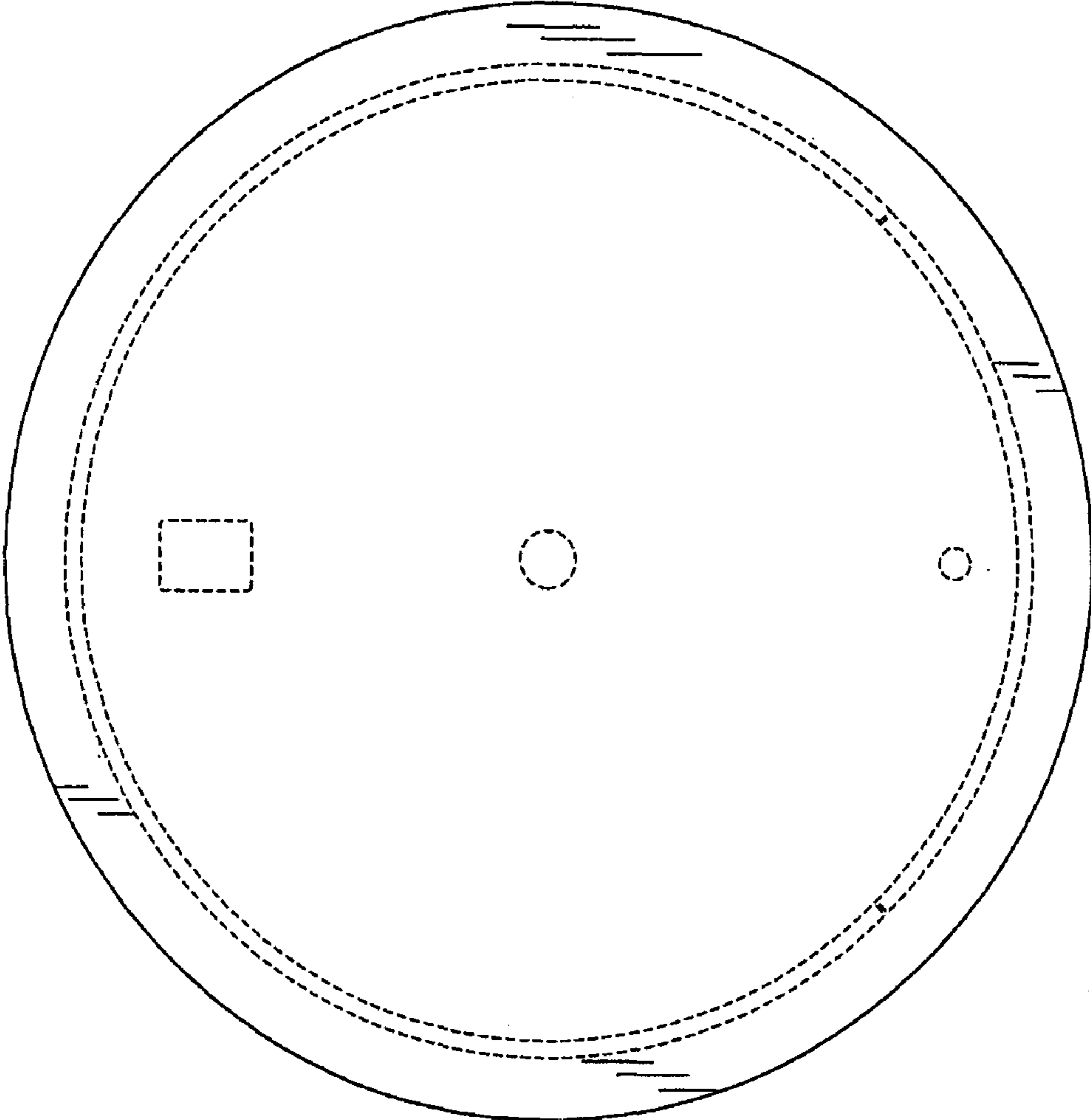

Fig.4

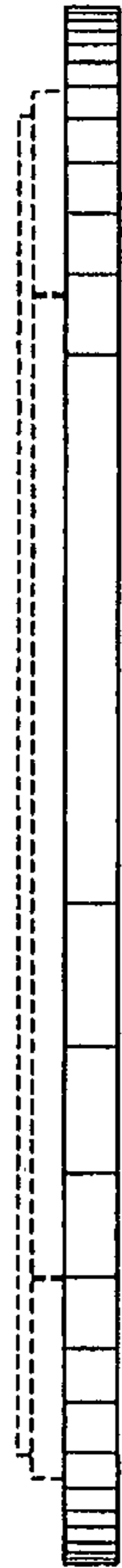

Fig.5



Fig.6

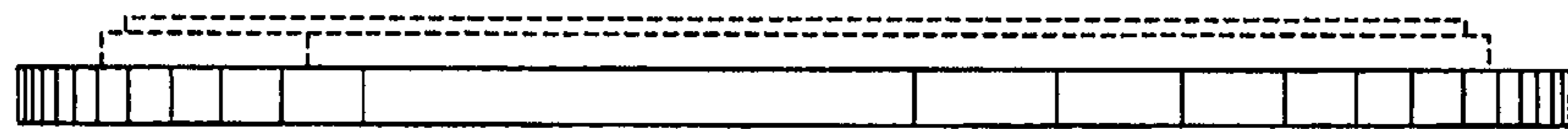

Fig.7

