



US00D625620S

(12) **United States Design Patent**
Chastaingt

(10) **Patent No.:** **US D625,620 S**

(45) **Date of Patent:** **** Oct. 19, 2010**

(54) **WATCH**

(75) **Inventor:** **Arnaud Chastaingt, Paris (FR)**

(73) **Assignee:** **Cartier Creation Studio SA (CH)**

(**) **Term:** **14 Years**

(21) **Appl. No.:** **29/356,993**

(22) **Filed:** **Mar. 5, 2010**

(51) **LOC (9) Cl.** **10-02**

(52) **U.S. Cl.** **D10/39**

(58) **Field of Classification Search** D10/30-39,
D10/122-132; 368/276, 281, 282, 285, 283,
368/286, 287

See application file for complete search history.

(56) **References Cited**

U.S. PATENT DOCUMENTS

1,169,935	A	*	2/1916	Dennison	368/286
1,199,256	A	*	9/1916	Farr	368/286
D51,182	S	*	8/1917	Lederer	D10/132
D51,225	S	*	9/1917	Dean	D10/132
D51,239	S	*	9/1917	Purver	D10/128
D51,298	S	*	9/1917	Brown	D10/132
D52,845	S	*	1/1919	Lederer	D10/132
1,672,337	A	*	6/1928	Palliser	63/1.13
D250,694	S	*	1/1979	Perrin	D10/39
D296,994	S	*	8/1988	Lauper	D10/39
4,939,913	A	*	7/1990	Scungio et al.	63/21
D314,710	S	*	2/1991	Weil	D10/32
D324,829	S	*	3/1992	Bock	D10/126
D386,979	S	*	12/1997	Kubisch	D10/32

D476,580	S	*	7/2003	Calvani et al.	D10/30
D481,967	S	*	11/2003	Cohen	D10/132
D554,005	S	*	10/2007	Laucella	D10/39
D558,633	S	*	1/2008	Wei	D10/126
D564,910	S	*	3/2008	Rabassa	D10/39
D569,277	S	*	5/2008	Chastaingt	D10/39
D580,278	S	*	11/2008	Hegi	D10/32
D580,796	S	*	11/2008	Calvani	D10/33
D610,923	S	*	3/2010	Duport et al.	D10/38

* cited by examiner

Primary Examiner—Lucy Lieberman

(74) *Attorney, Agent, or Firm*—Galbreath Law Offices, P.C.;
John A. Galbreath

(57) **CLAIM**

The ornamental design for a watch, as shown and described.

DESCRIPTION

FIG. 1 is a top view of the invention;

FIG. 2 is a bottom view of the invention;

FIG. 3 is a side view of the invention;

FIG. 4 is a front view of the invention;

FIG. 5 is another side view of the invention, showing the side opposite that shown in FIG. 3;

FIG. 6 is a back view of the invention; and,

FIG. 7 is a perspective view of the invention.

The portions of the watch that are shown in broken lines in the drawings are for illustrative purposes only and do not form part of the claimed design.

1 Claim, 1 Drawing Sheet

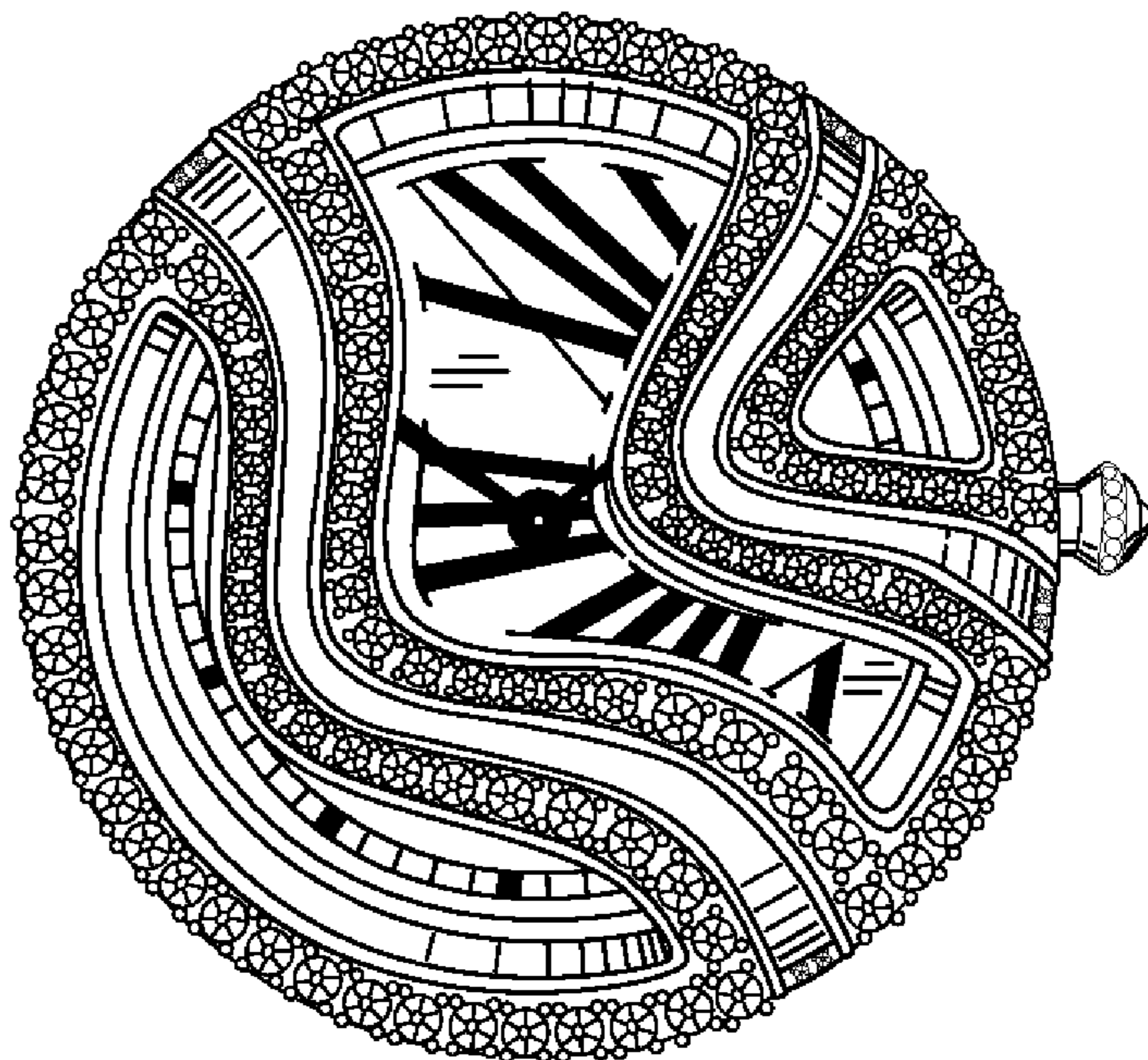

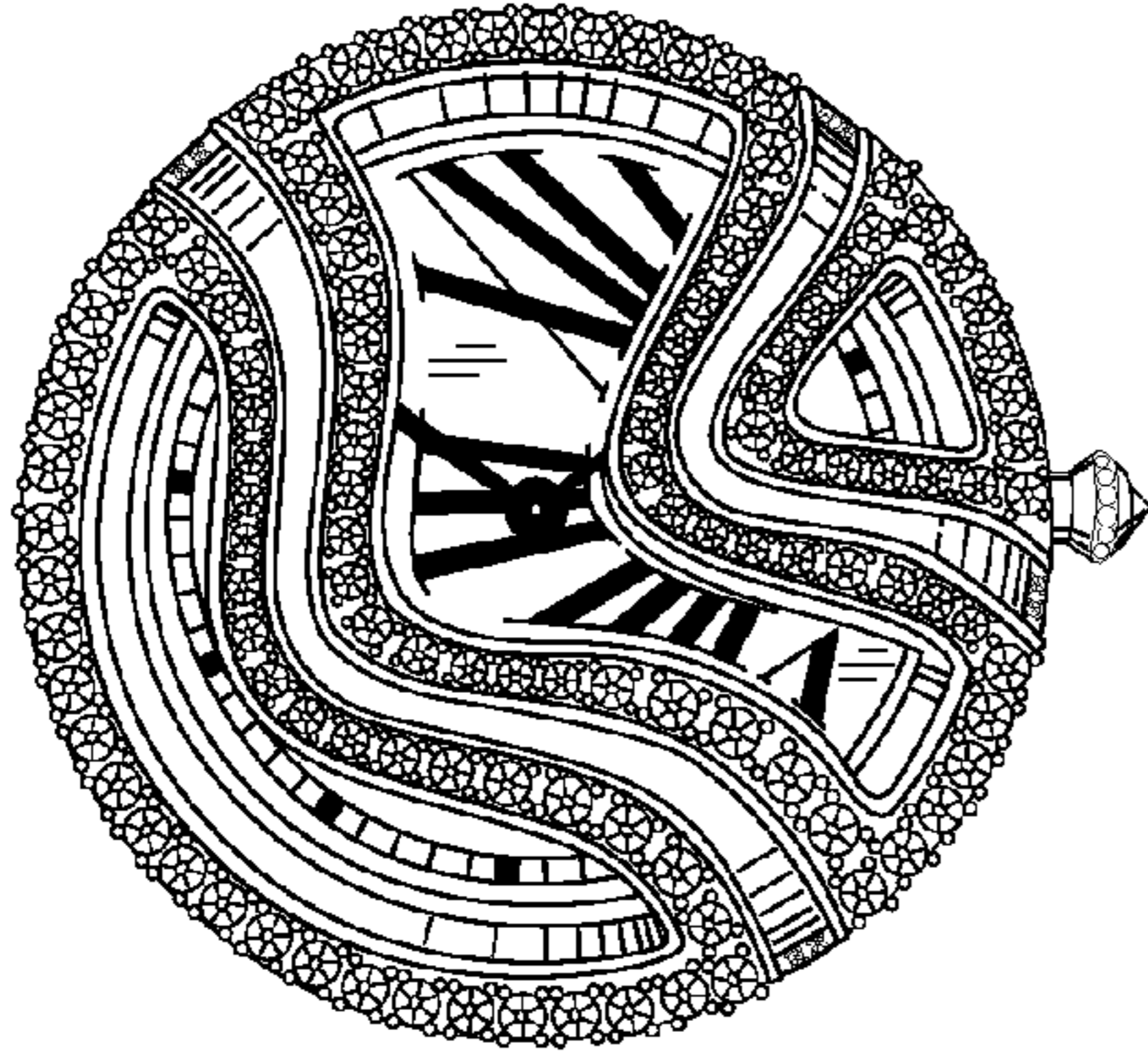

FIG. 1

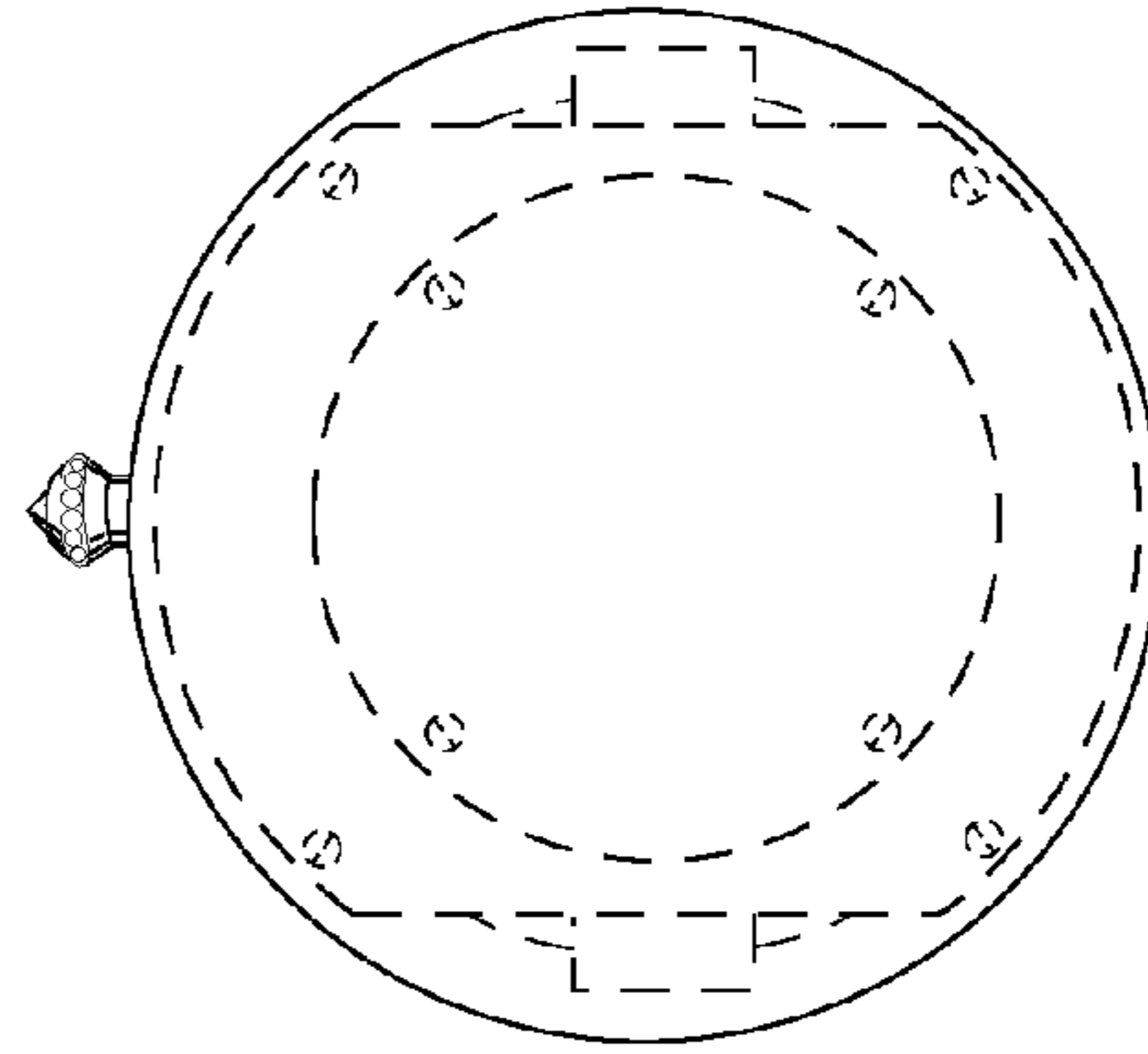

FIG. 2

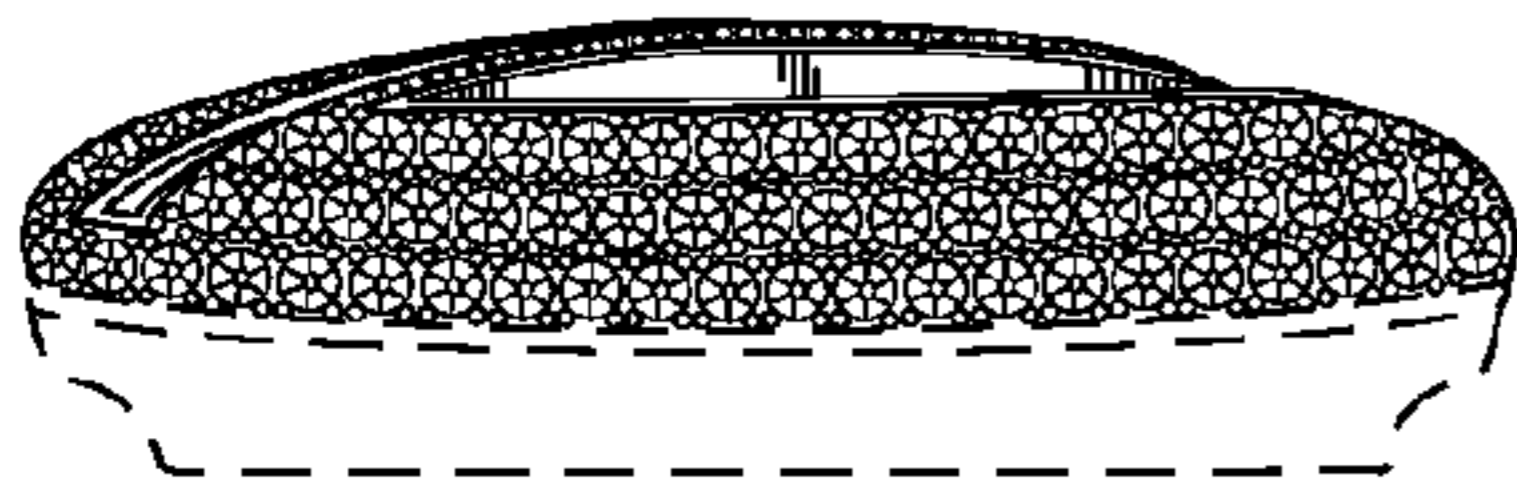

FIG. 3

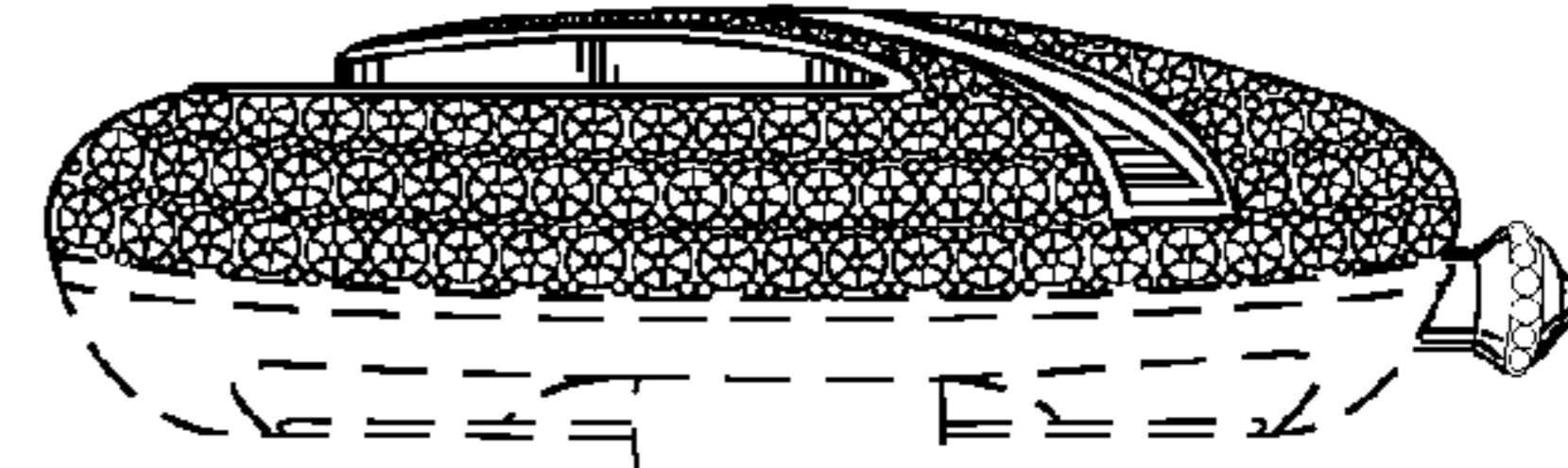

FIG. 4

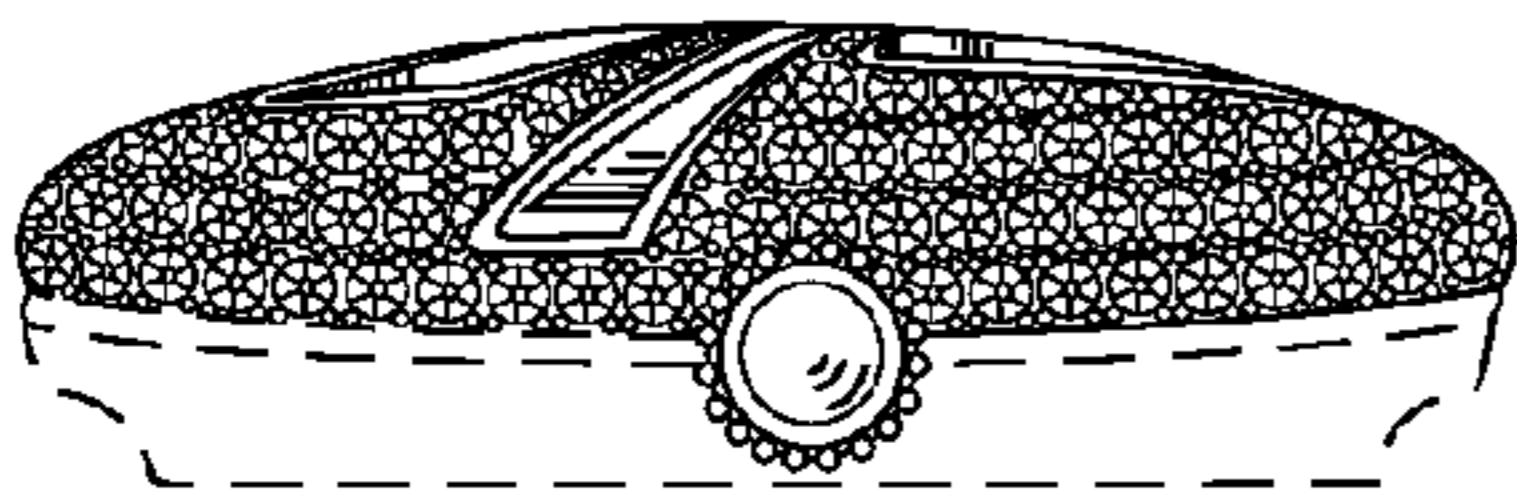

FIG. 5

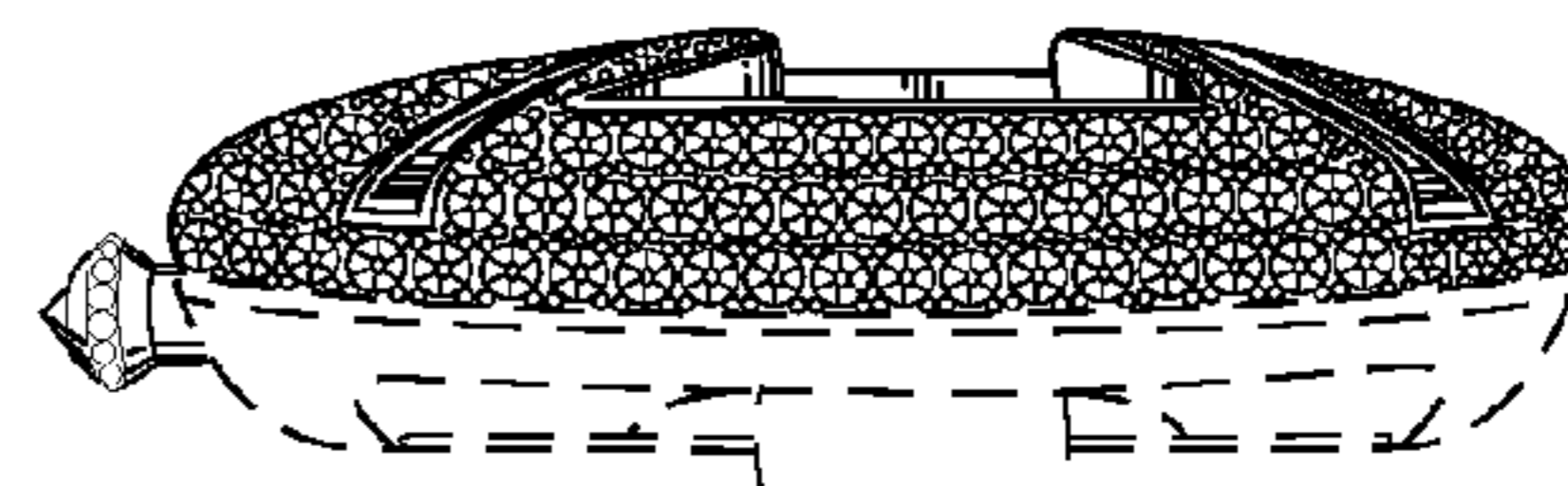

FIG. 6

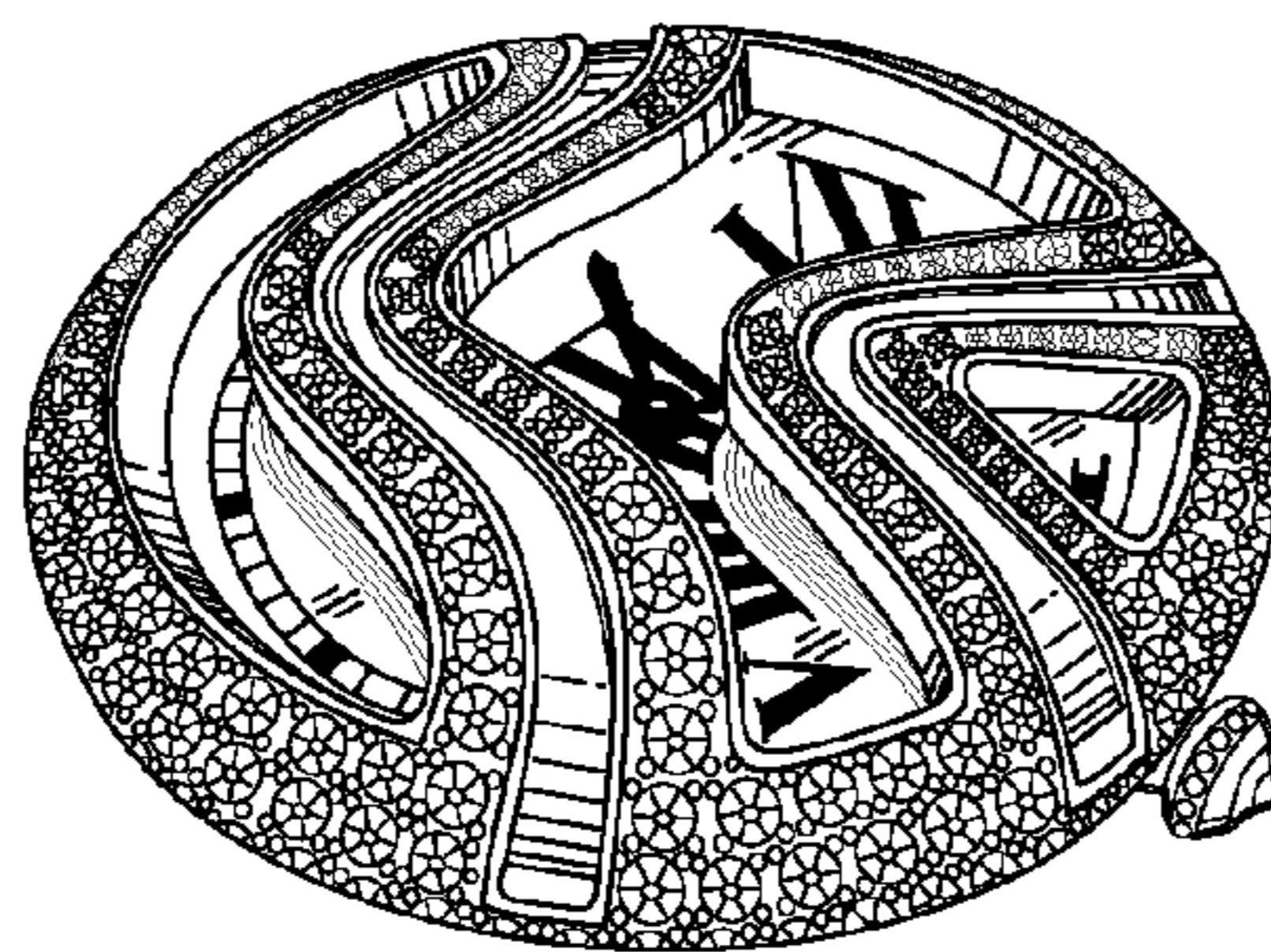

FIG. 7