



US00D625617S

(12) **United States Design Patent**  
**Chastaingt**

(10) **Patent No.:** **US D625,617 S**  
(45) **Date of Patent:** **\*\* Oct. 19, 2010**

(54) **WATCH CASE**

D531,063 S \* 10/2006 Reginelli ..... D10/32  
D540,200 S \* 4/2007 Chastaingt ..... D10/39  
D569,277 S \* 5/2008 Chastaingt ..... D10/39

(75) Inventor: **Arnaud Chastaingt**, Paris (FR)

\* cited by examiner

(73) Assignee: **Cartier Creation Studio SA** (CH)

*Primary Examiner*—Lucy Lieberman

(\*\*) Term: **14 Years**

(74) *Attorney, Agent, or Firm*—Galbreath Law Offices, P.C.;  
John A. Galbreath

(21) Appl. No.: **29/356,987**

(22) Filed: **Mar. 5, 2010**

(57) **CLAIM**

(51) **LOC (9) Cl.** ..... **10-02**

The ornamental design for a watch case, as shown and described.

(52) **U.S. Cl.** ..... **D10/38**

(58) **Field of Classification Search** ..... D10/30–39;  
368/276, 281, 282, 285

**DESCRIPTION**

See application file for complete search history.

FIG. 1 is a top view of the invention;

FIG. 2 is a bottom view of the invention;

FIG. 3 is a side view of the invention;

FIG. 4 is another side view of the invention, showing the side opposite that shown in FIG. 3;

FIG. 5 is a front view of the invention;

FIG. 6 is a back view of the invention; and,

FIG. 7 is a perspective view of the invention.

The portions of the watch case that are shown in broken lines in the drawings are for illustrative purposes only and do not form part of the claimed design.

(56) **References Cited**

U.S. PATENT DOCUMENTS

D79,166 S *	8/1929	Roth	.....	D10/39
D308,178 S *	5/1990	Zaboyan	.....	D10/124
D310,333 S *	9/1990	Fong	.....	D10/32
D311,693 S *	10/1990	Woomer	.....	D10/39
D321,664 S *	11/1991	Kennedy	.....	D10/30
D336,859 S *	6/1993	Muller	.....	D10/30
D348,845 S *	7/1994	Dumas	.....	D10/39
D350,488 S *	9/1994	Dunay	.....	D10/30
D361,727 S *	8/1995	Koga	.....	D10/32
D505,085 S *	5/2005	Lalo	.....	D10/30
D527,653 S *	9/2006	Dias	.....	D10/32

**1 Claim, 1 Drawing Sheet**

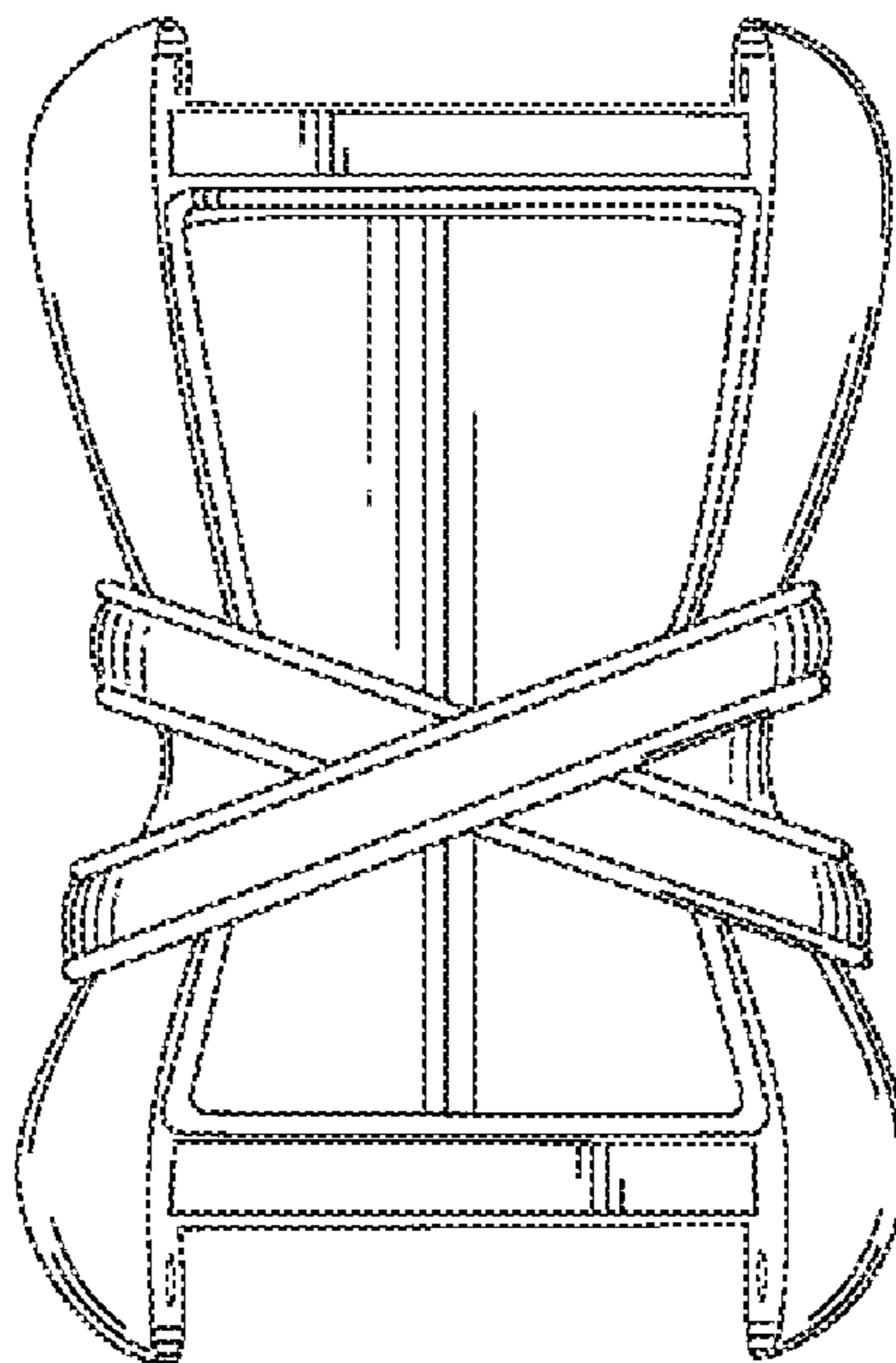

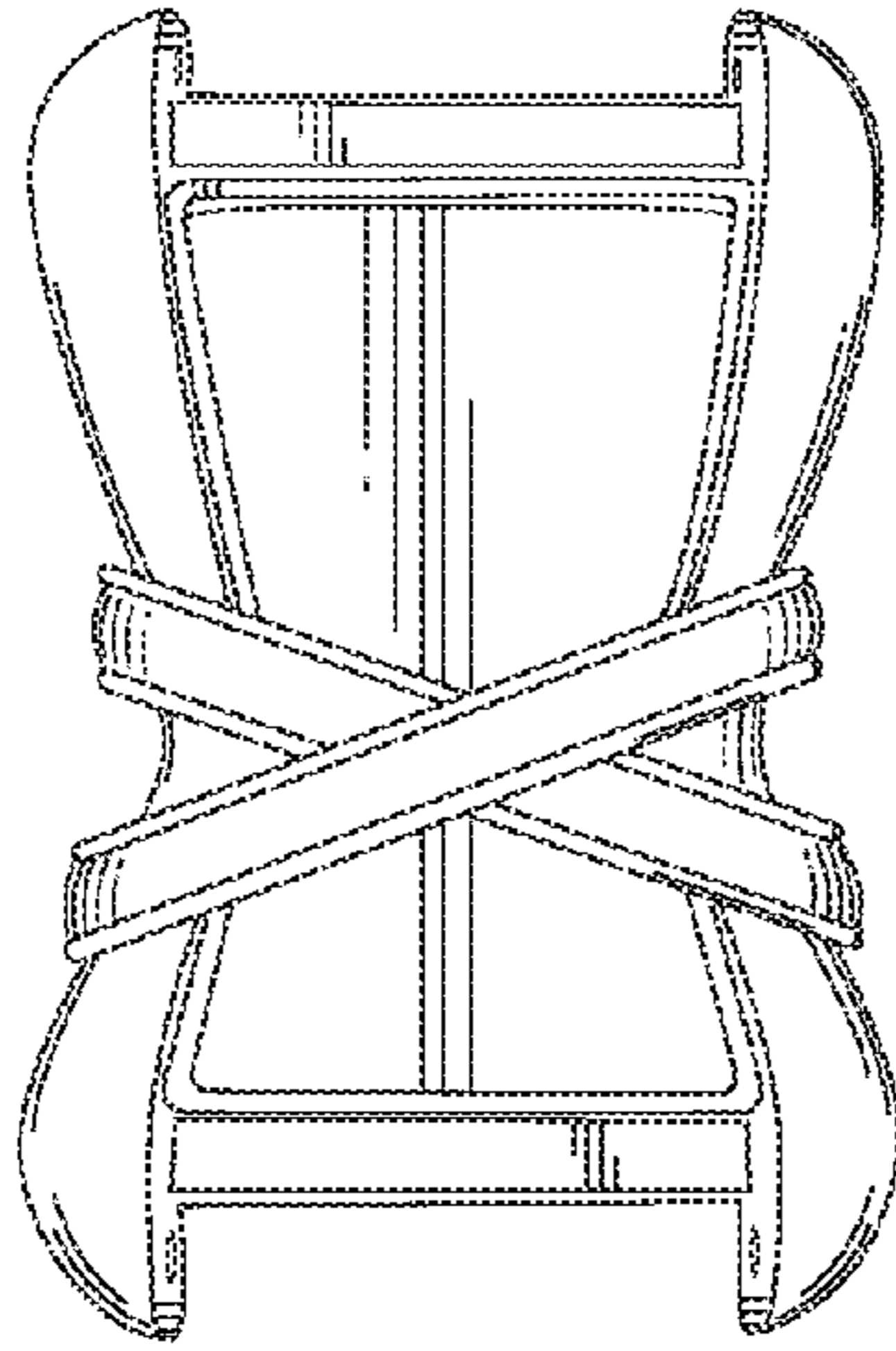

FIG. 1

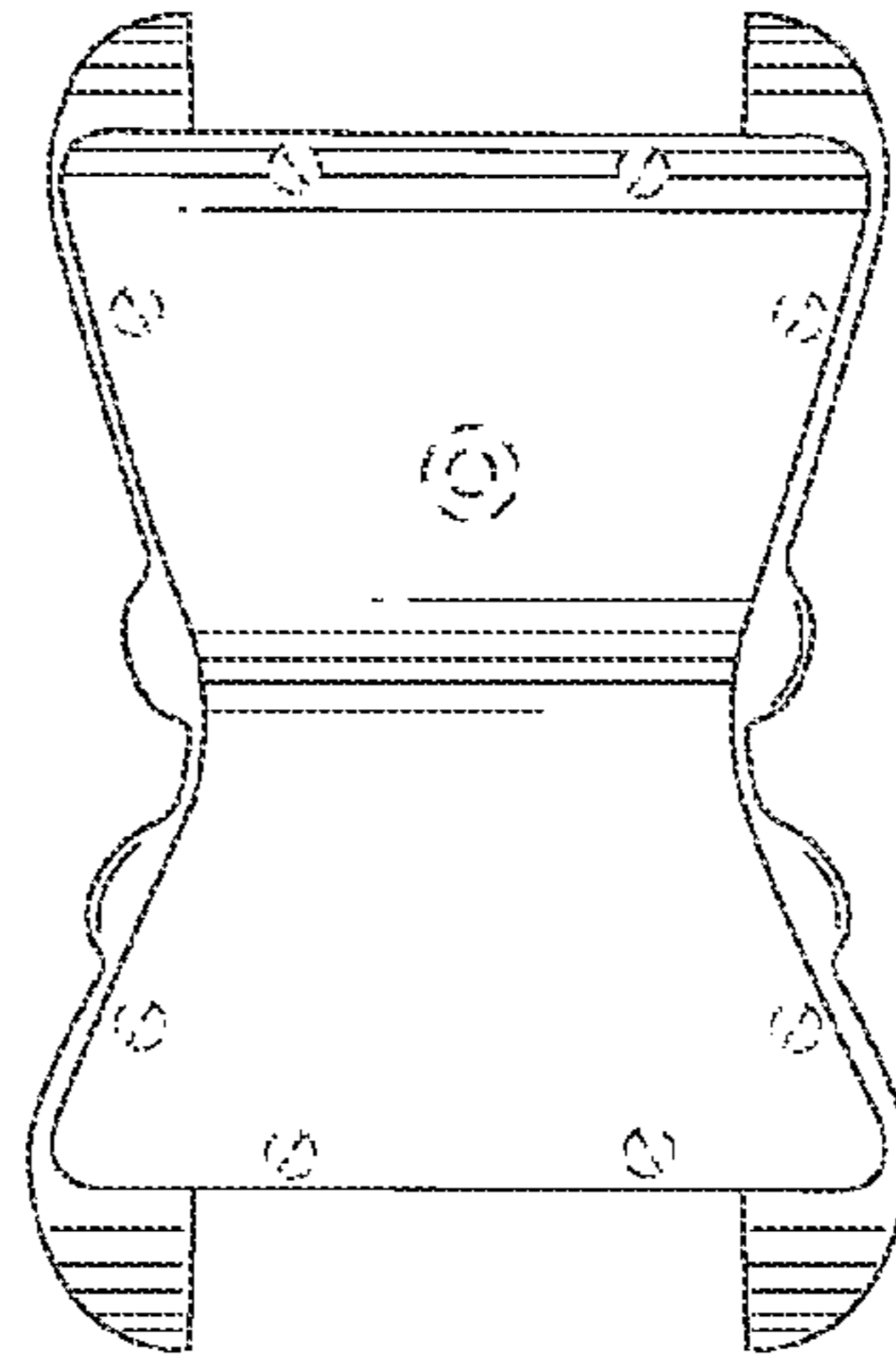

FIG. 2

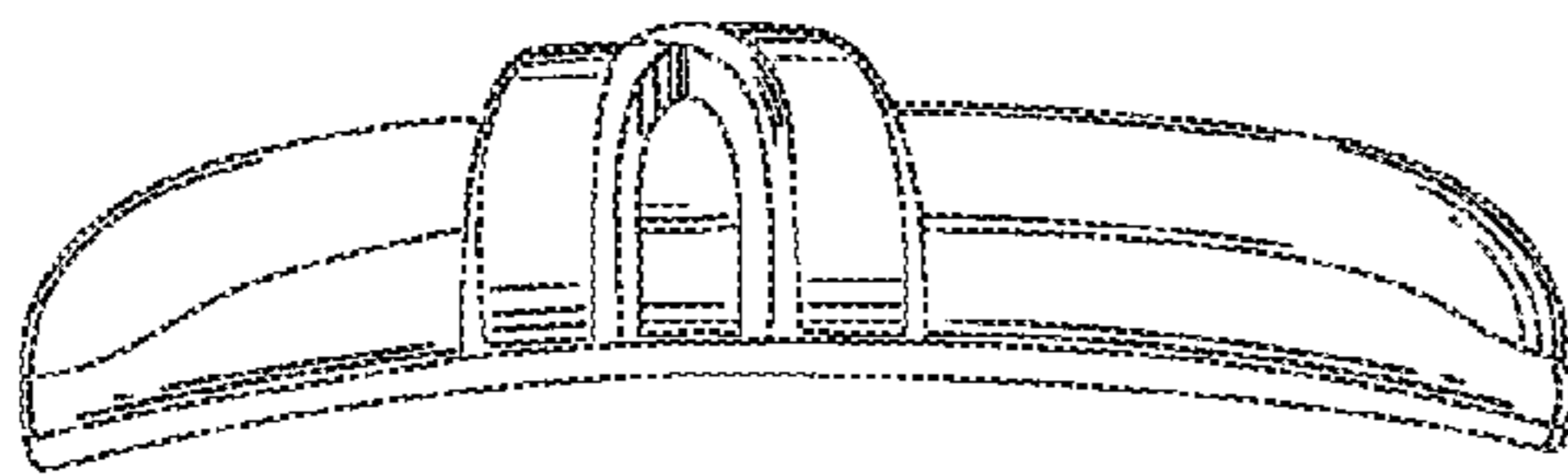

FIG. 3

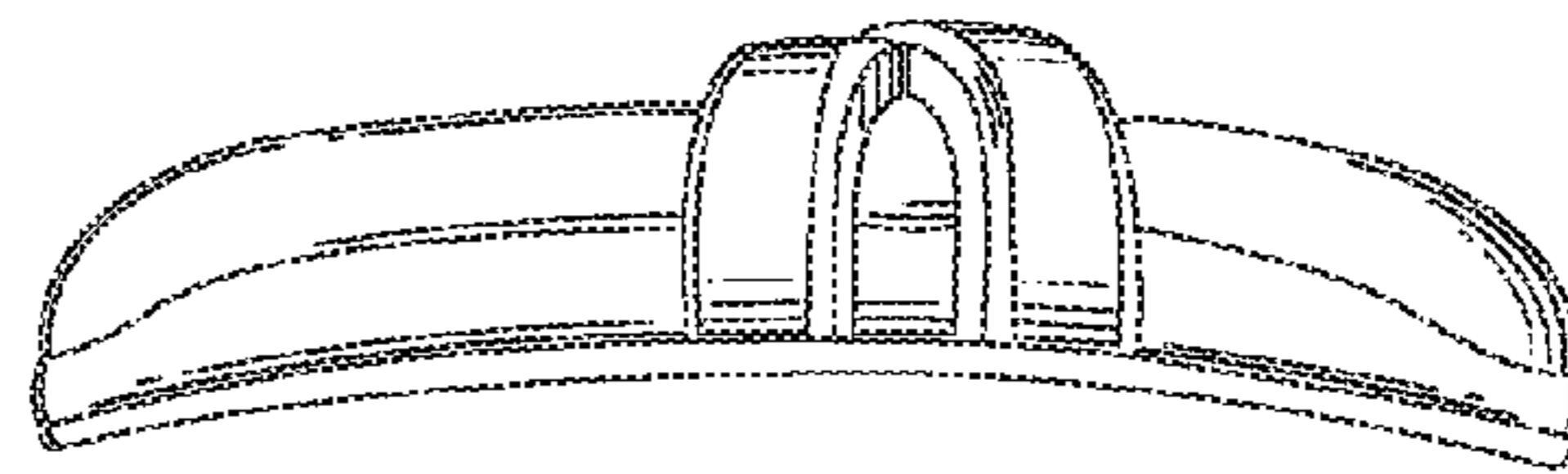

FIG. 4

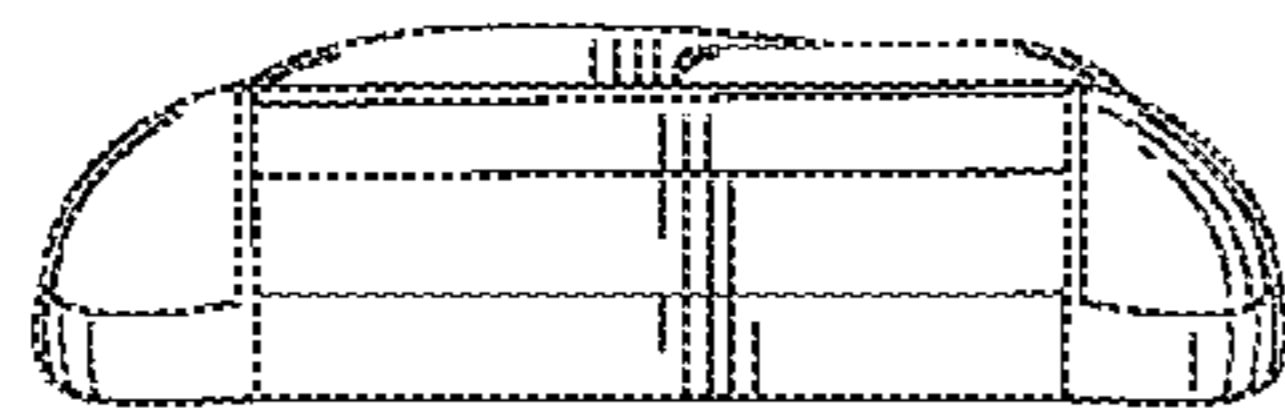

FIG. 5

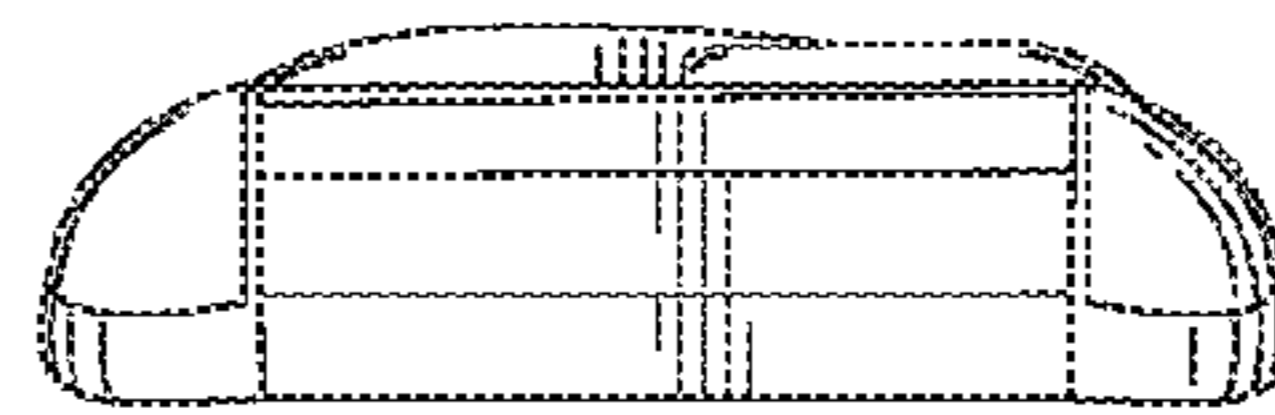

FIG. 6

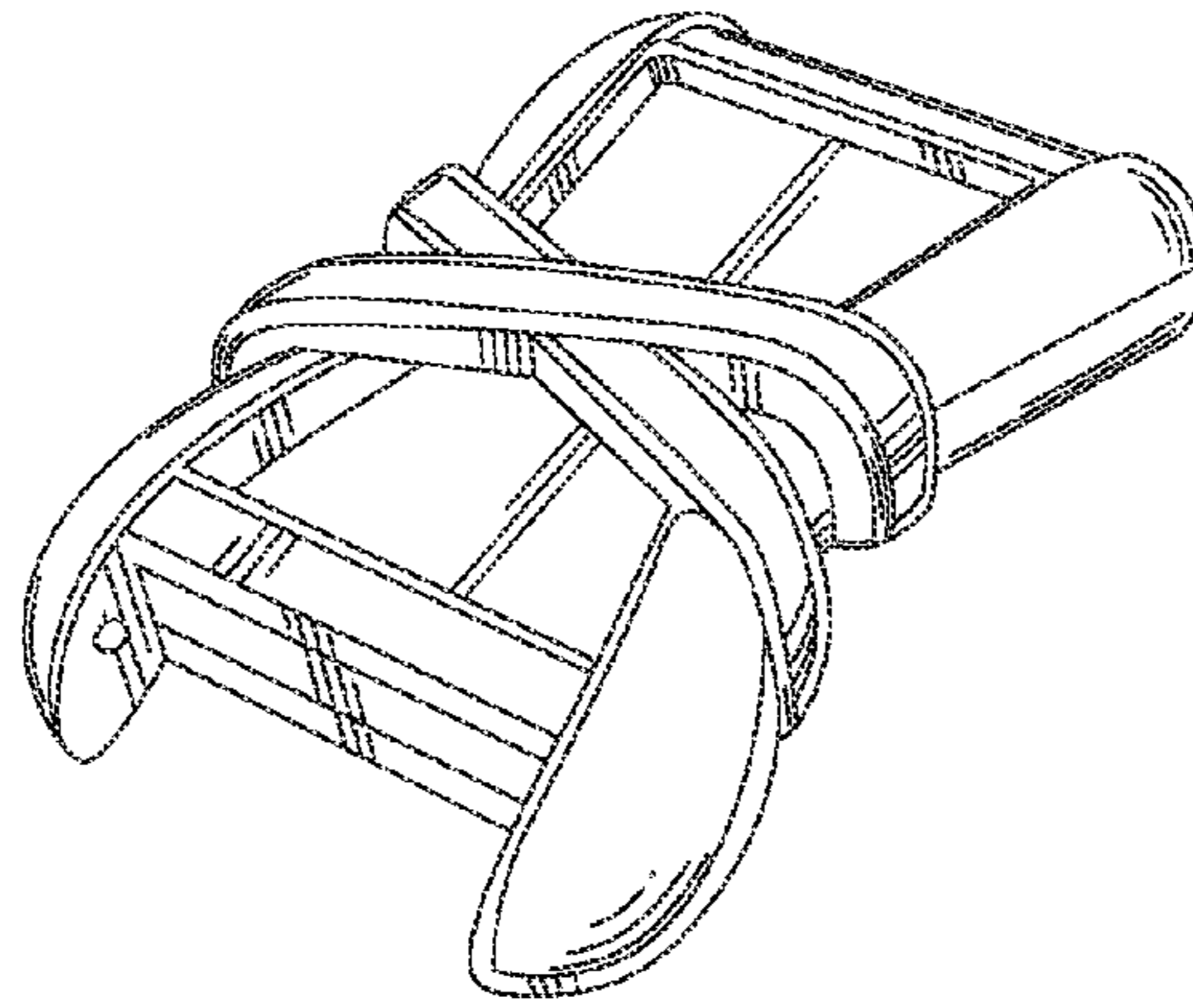

FIG. 7