



US00D625542S

(12) **United States Design Patent**  
**Picozza et al.**

(10) **Patent No.:** **US D625,542 S**  
(45) **Date of Patent:** **\*\* Oct. 19, 2010**

(54) **COFFEE MAKER**

(75) Inventors: **Augusto Picozza**, Boca Raton, FL (US);  
**Linda Makhanlall**, Coconut Creek, FL  
(US); **Marianne Grisdale**, Chicago, IL  
(US); **David Mucci**, Chicago, IL (US);  
**Siarhei MuraYOU**, Chicago, IL (US)

(73) Assignee: **Sunbeam Products, Inc.**, Boca Raton,  
FL (US)

(\*\*) Term: **14 Years**

(21) Appl. No.: **29/351,245**

(22) Filed: **Dec. 2, 2009**

(51) **LOC (9) Cl.** ..... **07-01**

(52) **U.S. Cl.** ..... **D7/309; D7/311; D7/399**

(58) **Field of Classification Search** ..... D7/309-311,  
D7/306-308, 399; 99/299, 279, 280, 300,  
99/302

See application file for complete search history.

(56) **References Cited**

**U.S. PATENT DOCUMENTS**

|              |        |                 |       |        |
|--------------|--------|-----------------|-------|--------|
| D513,917 S * | 1/2006 | Edrington       | ..... | D7/309 |
| D523,279 S * | 6/2006 | Zemp            | ..... | D7/309 |
| D526,828 S * | 8/2006 | Jordana         | ..... | D7/309 |
| D559,611 S * | 1/2008 | Cheong          | ..... | D7/306 |
| D570,636 S * | 6/2008 | Kulujian et al. | ..... | D7/306 |
| D584,096 S * | 1/2009 | Lutz            | ..... | D7/307 |

|              |         |              |       |        |
|--------------|---------|--------------|-------|--------|
| D586,603 S * | 2/2009  | Borin        | ..... | D7/309 |
| D587,511 S * | 3/2009  | Buttler      | ..... | D7/309 |
| D595,991 S * | 7/2009  | Zimmerman    | ..... | D7/307 |
| D602,727 S * | 10/2009 | Nicolini     | ..... | D7/307 |
| D605,454 S * | 12/2009 | Nicolini     | ..... | D7/306 |
| D610,389 S * | 2/2010  | Borin et al. | ..... | D7/309 |
| D618,031 S * | 6/2010  | Mansour      | ..... | D7/307 |

\* cited by examiner

*Primary Examiner*—Marianne Pandozzi

(74) *Attorney, Agent, or Firm*—Seth M. Blum

(57) **CLAIM**

The ornamental design for a coffee maker, as shown and described.

**DESCRIPTION**

FIG. 1 is a front perspective view of the coffee maker showing the new design;

FIG. 2 is a front elevation view thereof;

FIG. 3 is a back elevation view thereof;

FIG. 4 is a left side elevation view thereof;

FIG. 5 is a right side elevation view thereof;

FIG. 6 is a top plan view thereof; and,

FIG. 7 is a bottom plan view thereof.

The broken lines in the drawings are for illustrative purposes only and form no part of the claimed design.

**1 Claim, 7 Drawing Sheets**

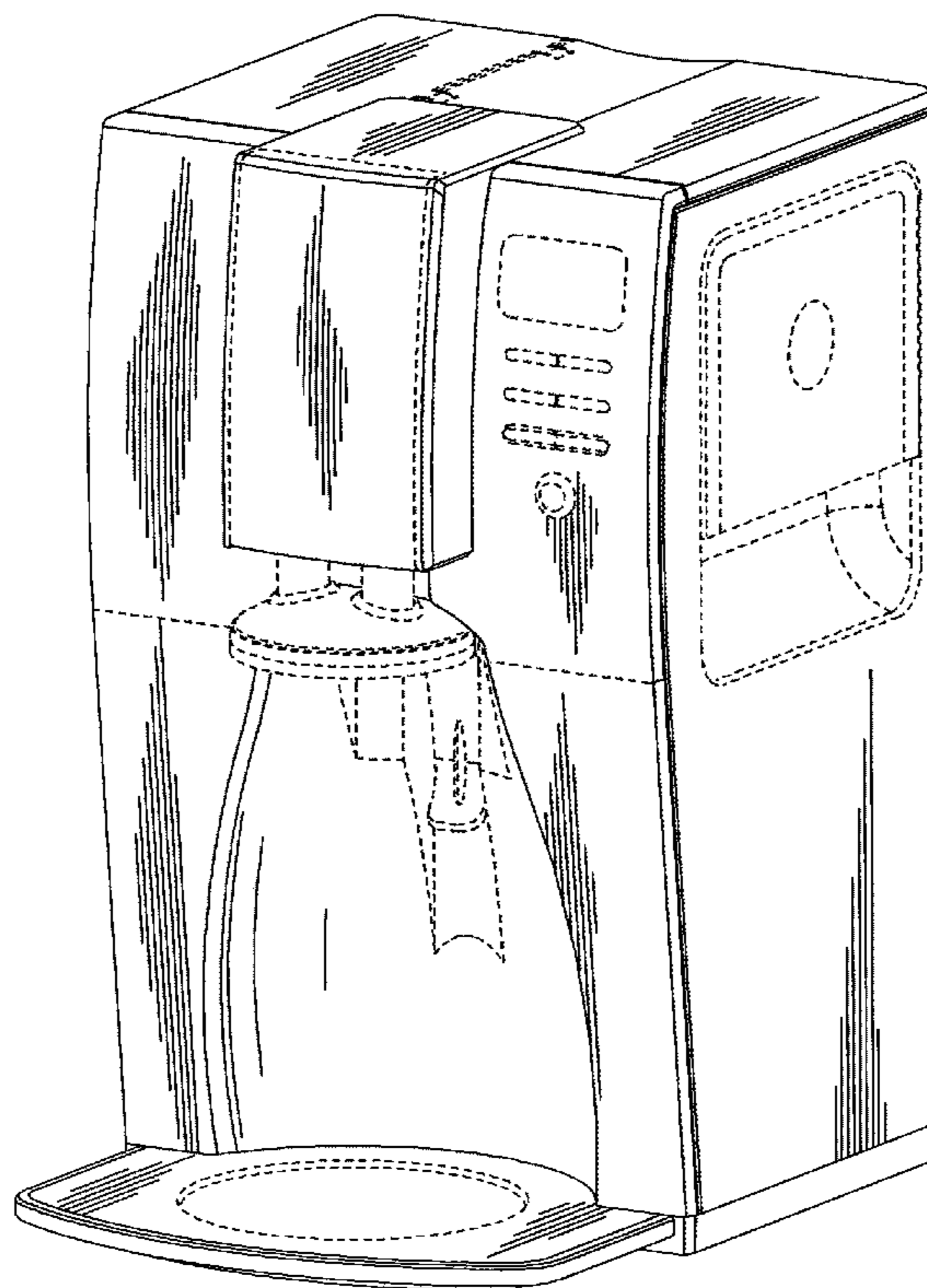

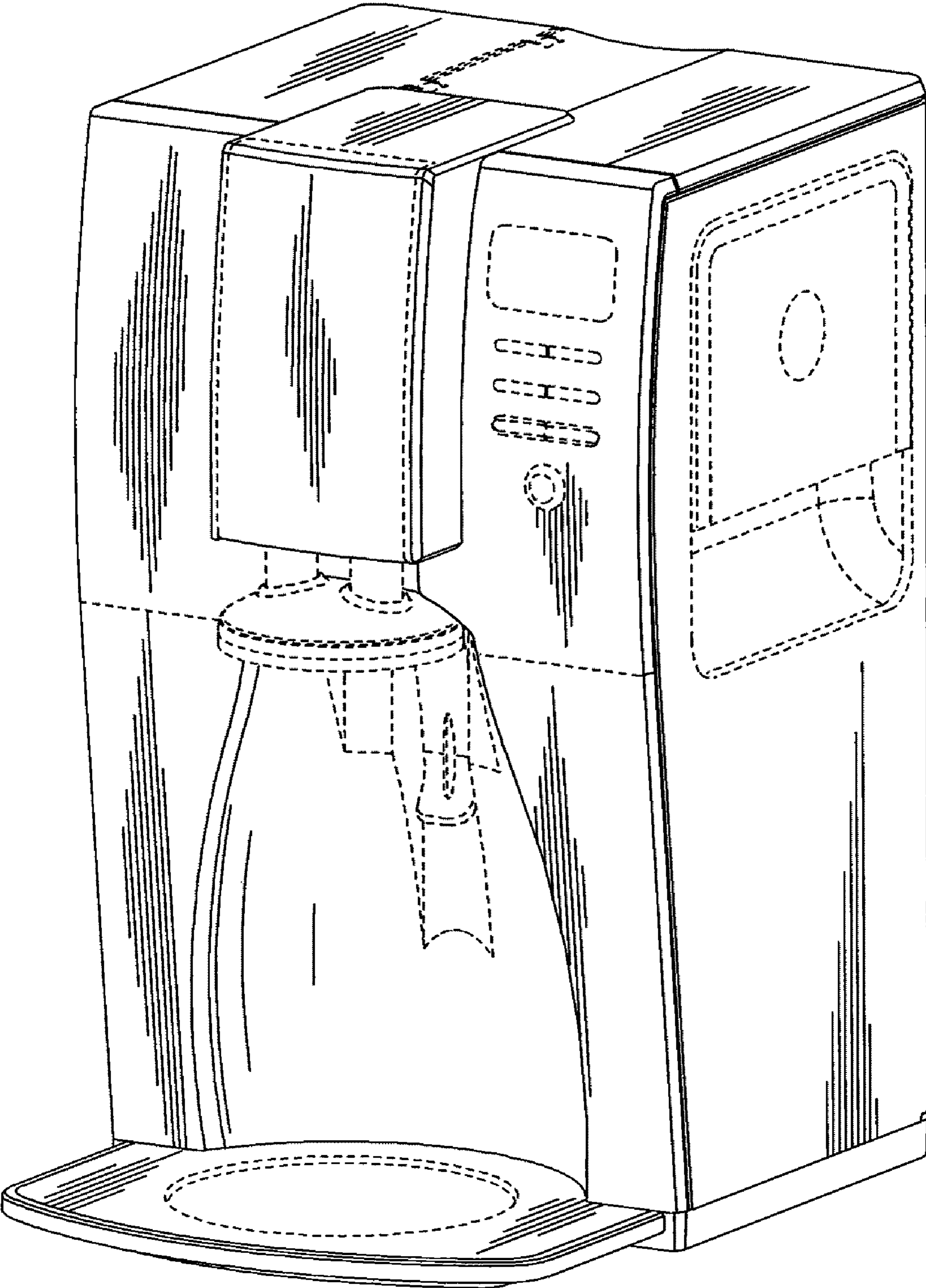

FIG 1

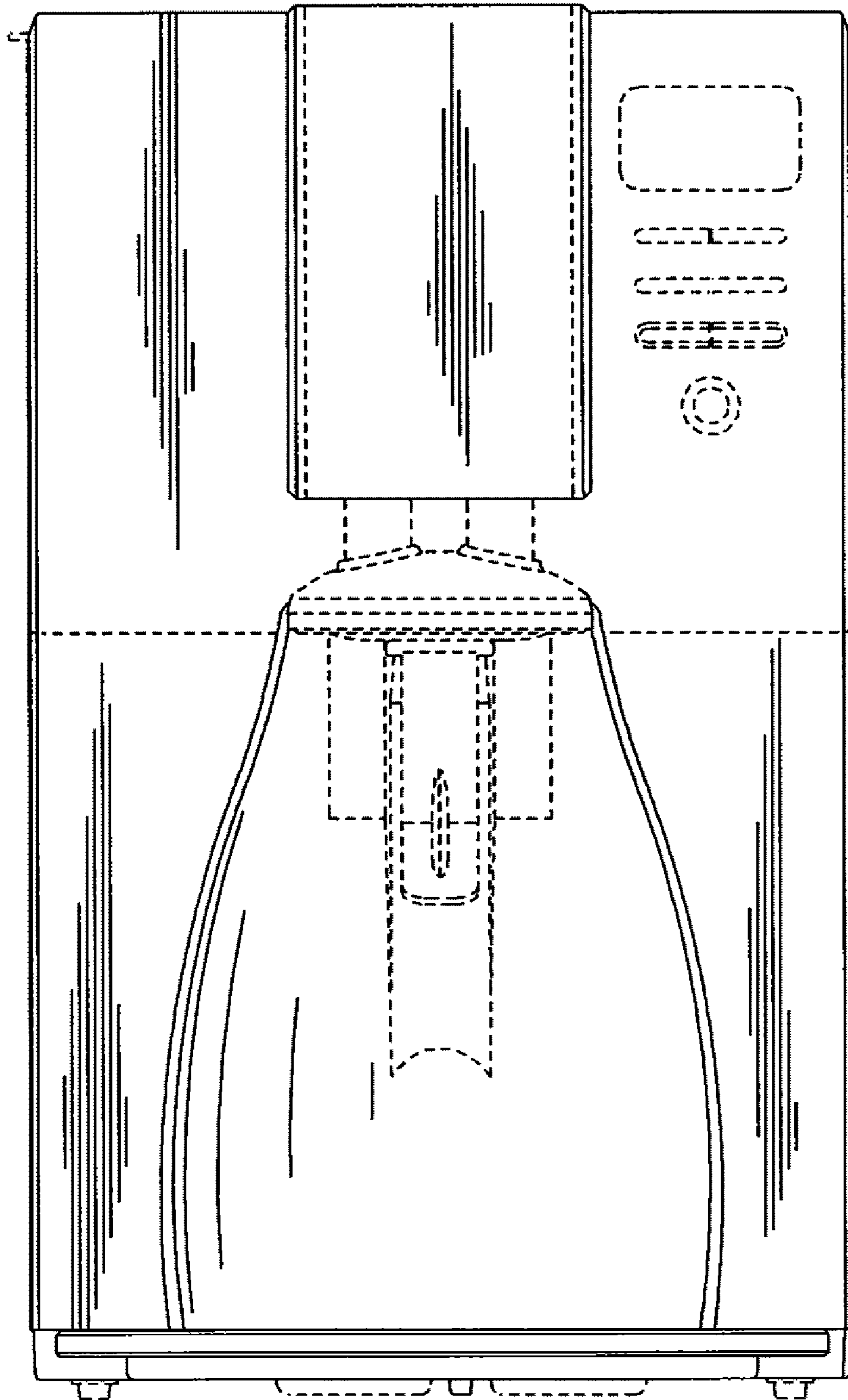

FIG 2

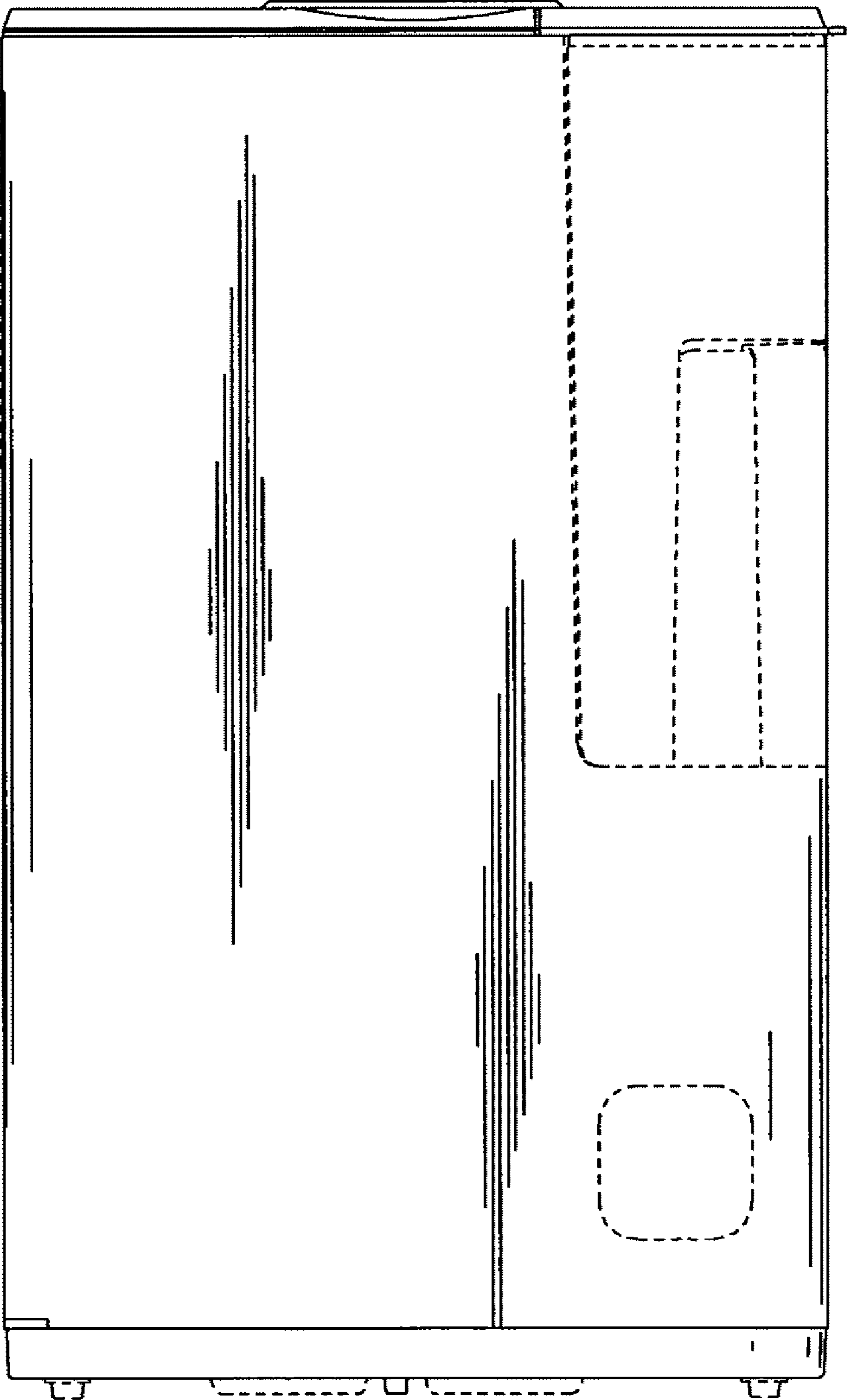

FIG 3

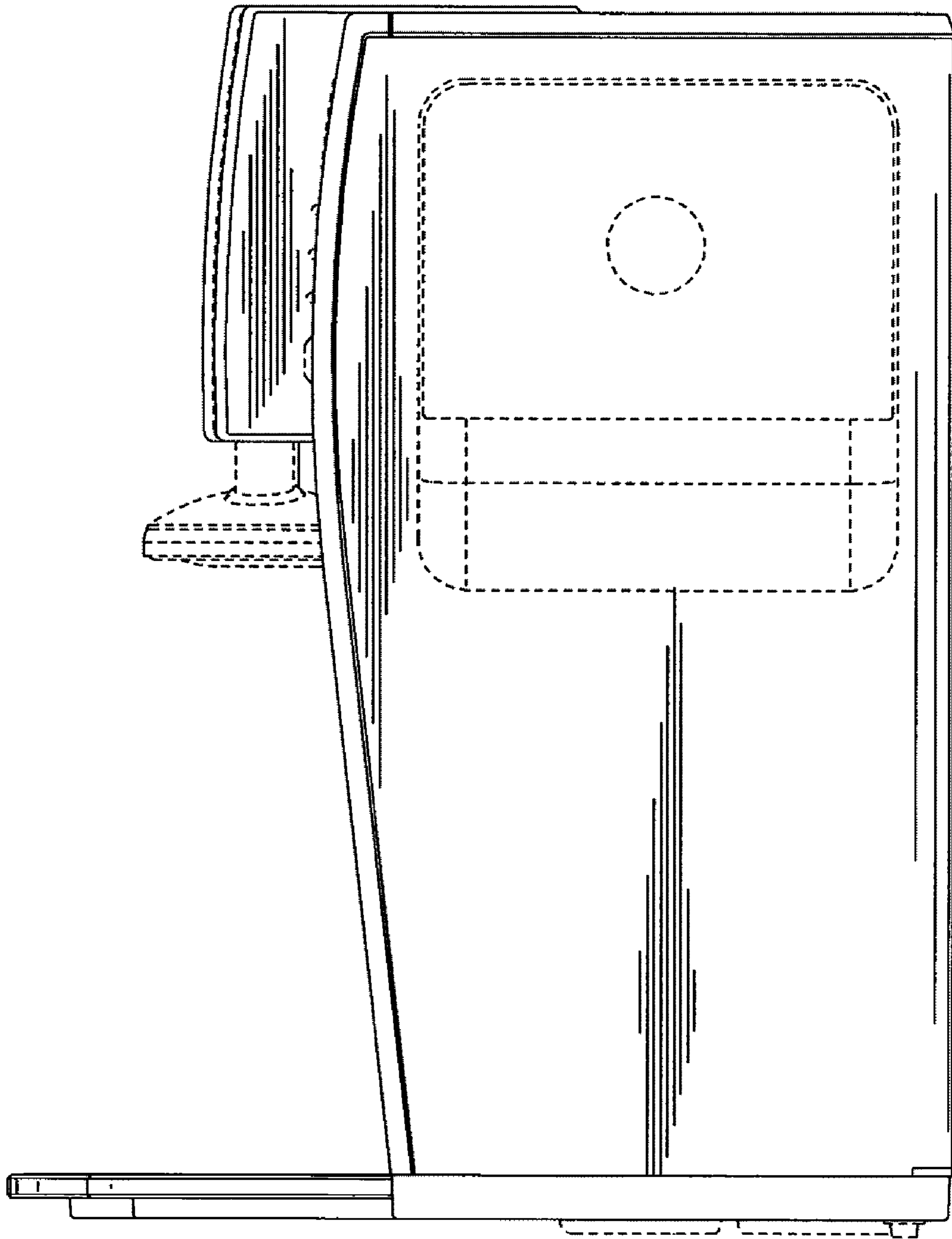

FIG 4

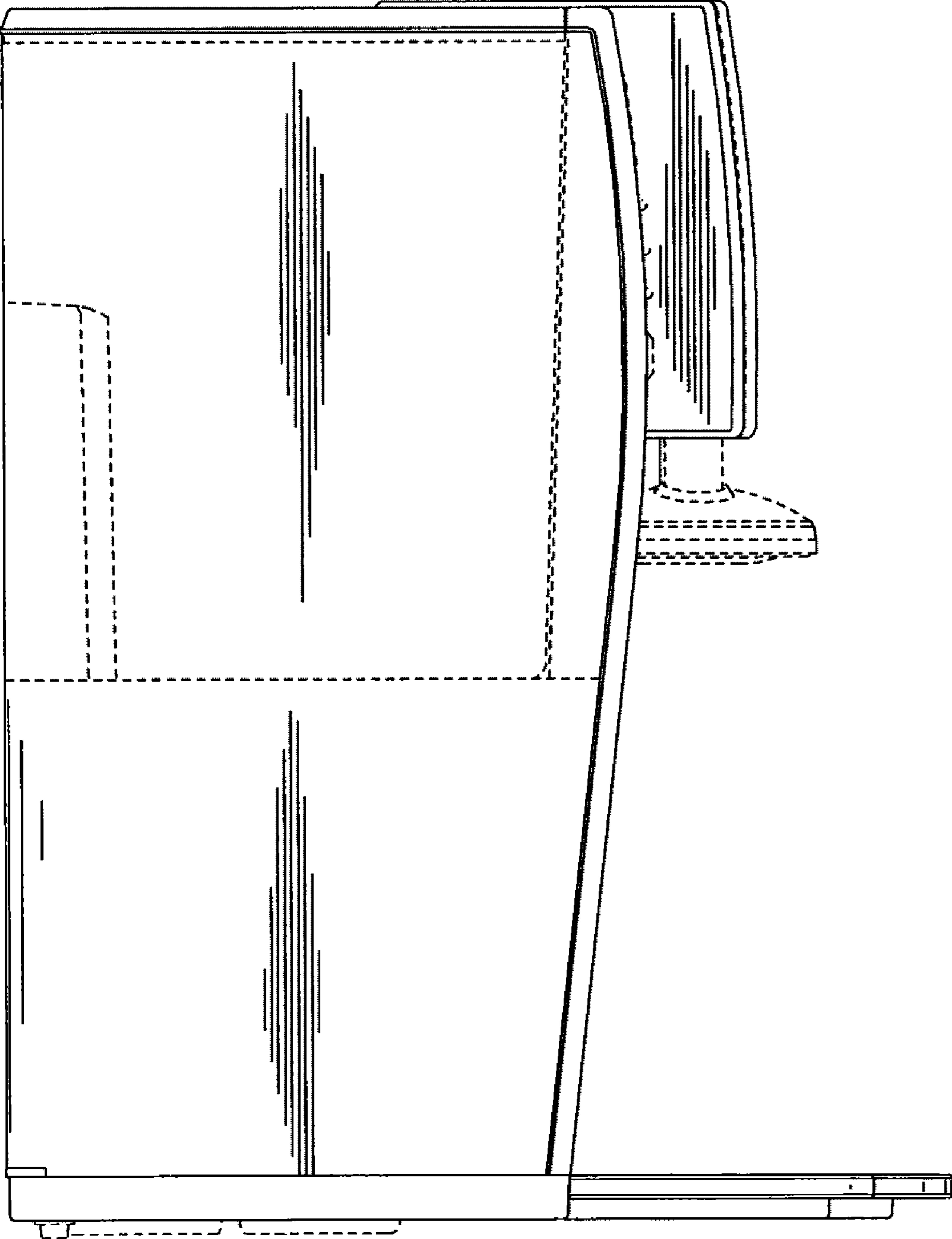

FIG 5

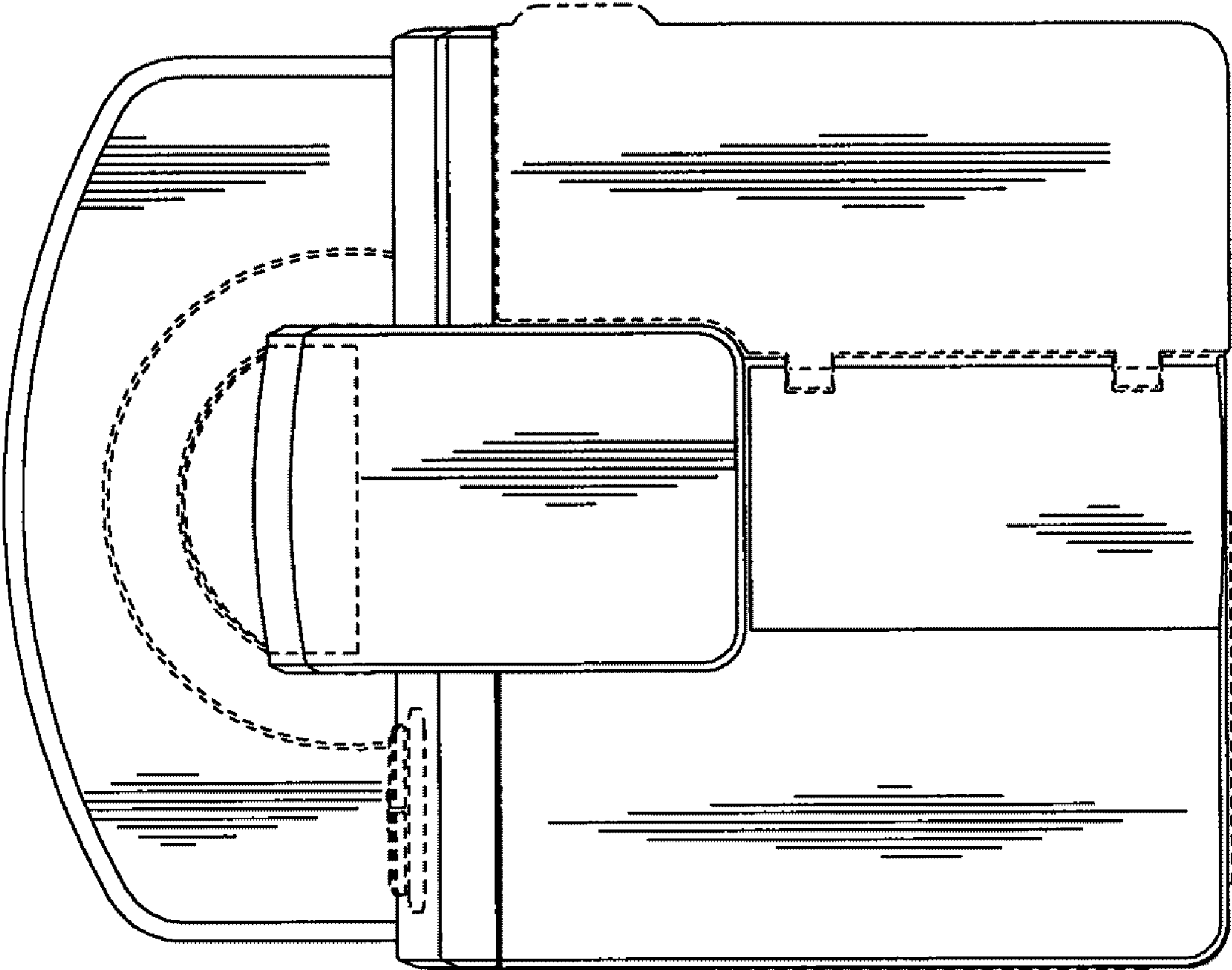

FIG 6

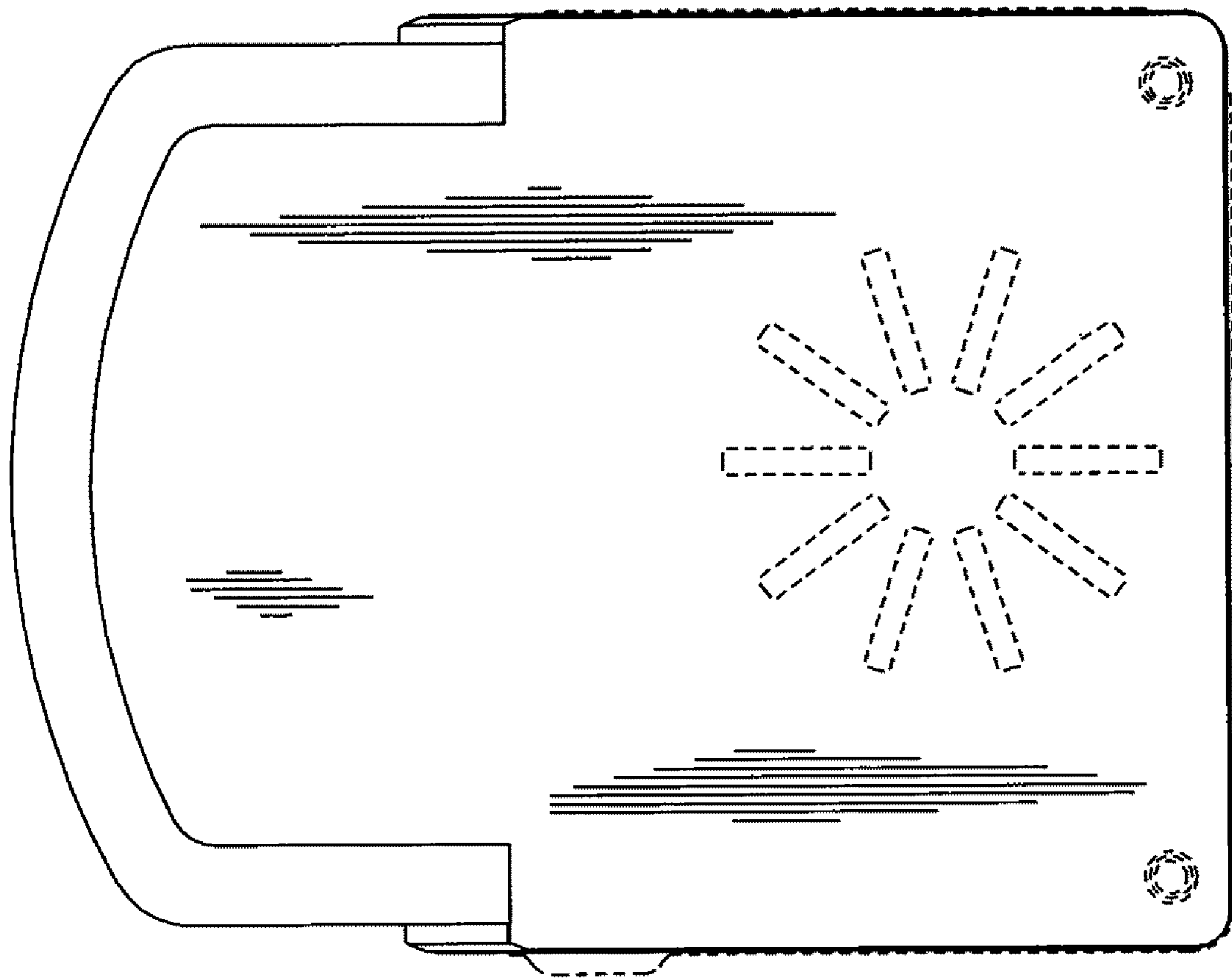

FIG 7