

US00D625432S

(12) **United States Design Patent**
Guenev

(10) **Patent No.:** **US D625,432 S**
(45) **Date of Patent:** **** Oct. 12, 2010**

(54) **ENCLOSURE FOR BIOPHARMACEUTICAL
PROCESSING EQUIPMENT**

D557,421 S * 12/2007 Fleck et al. D24/185
D560,131 S * 1/2008 Hu D10/81

(76) Inventor: **Guenko Guenev**, 116 Abby La., N.
Kingstown, RI (US) 02852

(Continued)

(**) Term: **14 Years**

Primary Examiner—T. Chase Nelson
Assistant Examiner—Mark Cavanna
(74) *Attorney, Agent, or Firm*—Barlow, Josephs & Holmes
Ltd.

(21) Appl. No.: **29/355,838**

(22) Filed: **Feb. 15, 2010**

(57) **CLAIM**

(51) **LOC (9) Cl.** **24-02**

(52) **U.S. Cl.** **D24/232**

(58) **Field of Classification Search** D10/81;
D24/107, 158, 164, 165, 167, 170, 185–187,
D24/231–233, 108, 217; 73/864.01, 864.12;
134/21, 22.11, 24, 26–27, 169 R; 422/62–64,
422/99, 100; 436/47, 49, 179, 180; D13/162–163;
600/300, 301, 368, 372, 481, 529, 544, 554,
600/561

The ornamental design for enclosure for biopharmaceutical processing equipment, as shown and described.

DESCRIPTION

See application file for complete search history.

FIG. 1 is a front perspective view of the enclosure for biopharmaceutical processing equipment, showing the new design; the portions shown in broken lines form no part of the claimed invention;

FIG. 2 is a rear perspective view of the enclosure for biopharmaceutical processing equipment, showing the new design; the portions shown in broken lines form no part of the claimed invention;

(56) **References Cited**

U.S. PATENT DOCUMENTS

D370,979 S *	6/1996	Pascale et al.	D24/169
D381,749 S *	7/1997	Lawrence et al.	D24/186
D389,916 S *	1/1998	DiPerna et al.	D24/169
D412,748 S *	8/1999	Nabarro	D24/160
D424,956 S *	5/2000	von Buelow et al.	D10/81
D430,304 S *	8/2000	Oonuma et al.	D24/232
D467,349 S *	12/2002	Niedbala et al.	D24/231
D469,176 S *	1/2003	Hall et al.	D24/108
D474,279 S *	5/2003	Mayer et al.	D24/232
D535,403 S *	1/2007	Isozaki et al.	D24/232
D537,951 S *	3/2007	Okamoto et al.	D24/233
D538,436 S *	3/2007	Patadia et al.	D24/217
D550,362 S *	9/2007	Olivera et al.	D24/185
D554,069 S *	10/2007	Bolotin et al.	D13/162
D554,070 S *	10/2007	Bolotin et al.	D13/162
D556,914 S *	12/2007	Okamoto et al.	D24/233

FIG. 3 is a front view thereof; the portions shown in broken lines form no part of the claimed invention;

FIG. 4 is a rear view thereof; the portions shown in broken lines form no part of the claimed invention;

FIG. 5 is a left view thereof; the portions shown in broken lines form no part of the claimed invention;

FIG. 6 is a right view thereof; the portions shown in broken lines form no part of the claimed invention;

FIG. 7 is top view thereof; the portions shown in broken lines form no part of the claimed invention; and,

FIG. 8 is a bottom view thereof; the portions shown in broken lines form no part of the claimed invention.

1 Claim, 8 Drawing Sheets

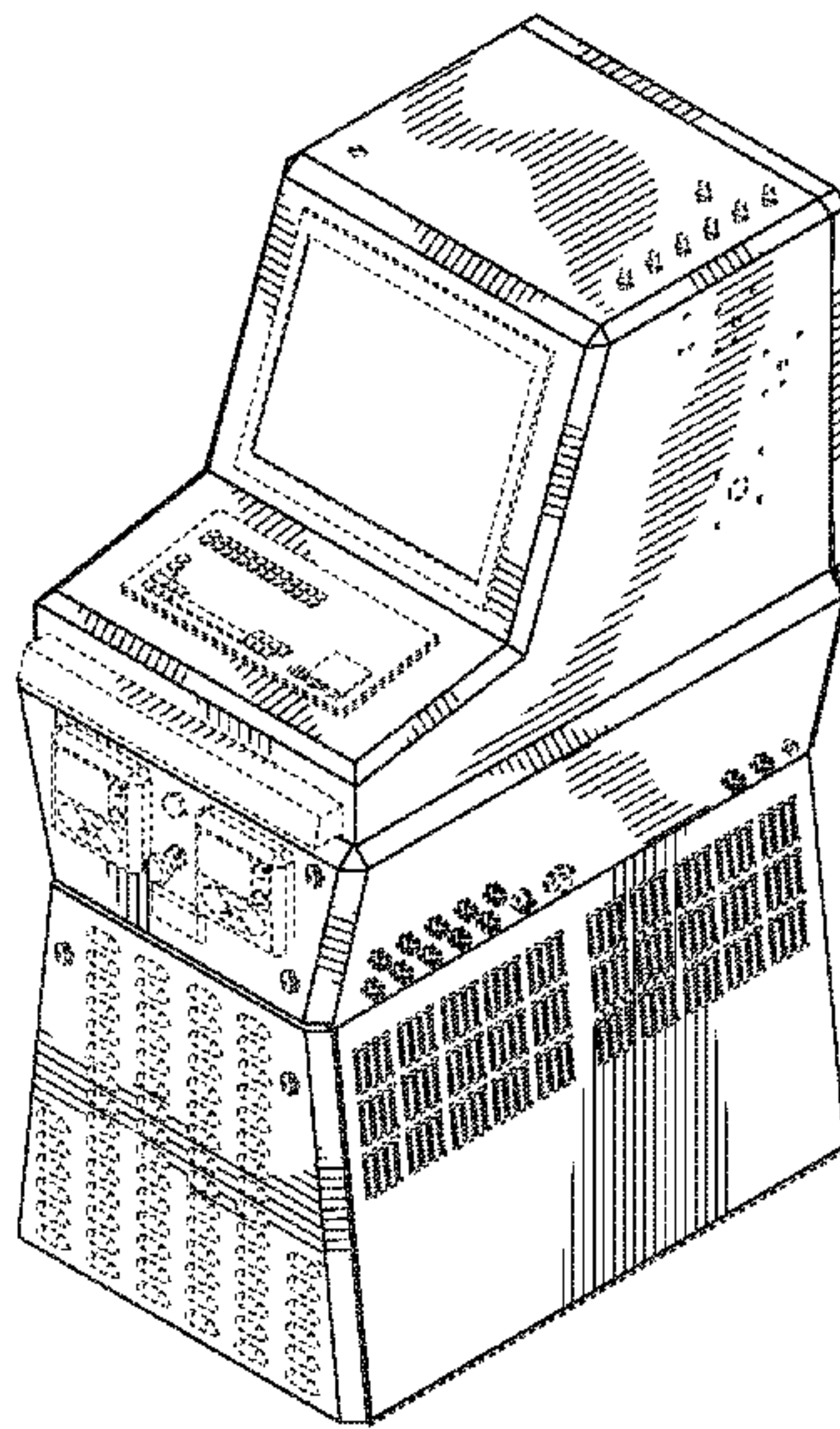

US D625,432 S

Page 2

U.S. PATENT DOCUMENTS

D561,342 S *	2/2008	Zimmer	D24/185	D591,864 S *	5/2009	Schmidt	D24/216
D568,258 S *	5/2008	Adam	D13/163	D603,048 S *	10/2009	Fleck et al.	D24/185
D569,526 S *	5/2008	Duffy et al.	D24/232	D607,569 S *	1/2010	Yukikado et al.	D24/186
D571,474 S *	6/2008	Sjo-Gaber et al.	D24/186	D611,610 S *	3/2010	Fleck et al.	D24/185
D588,276 S *	3/2009	Isozaki et al.	D24/232	D612,276 S *	3/2010	Duffy et al.	D10/81

* cited by examiner

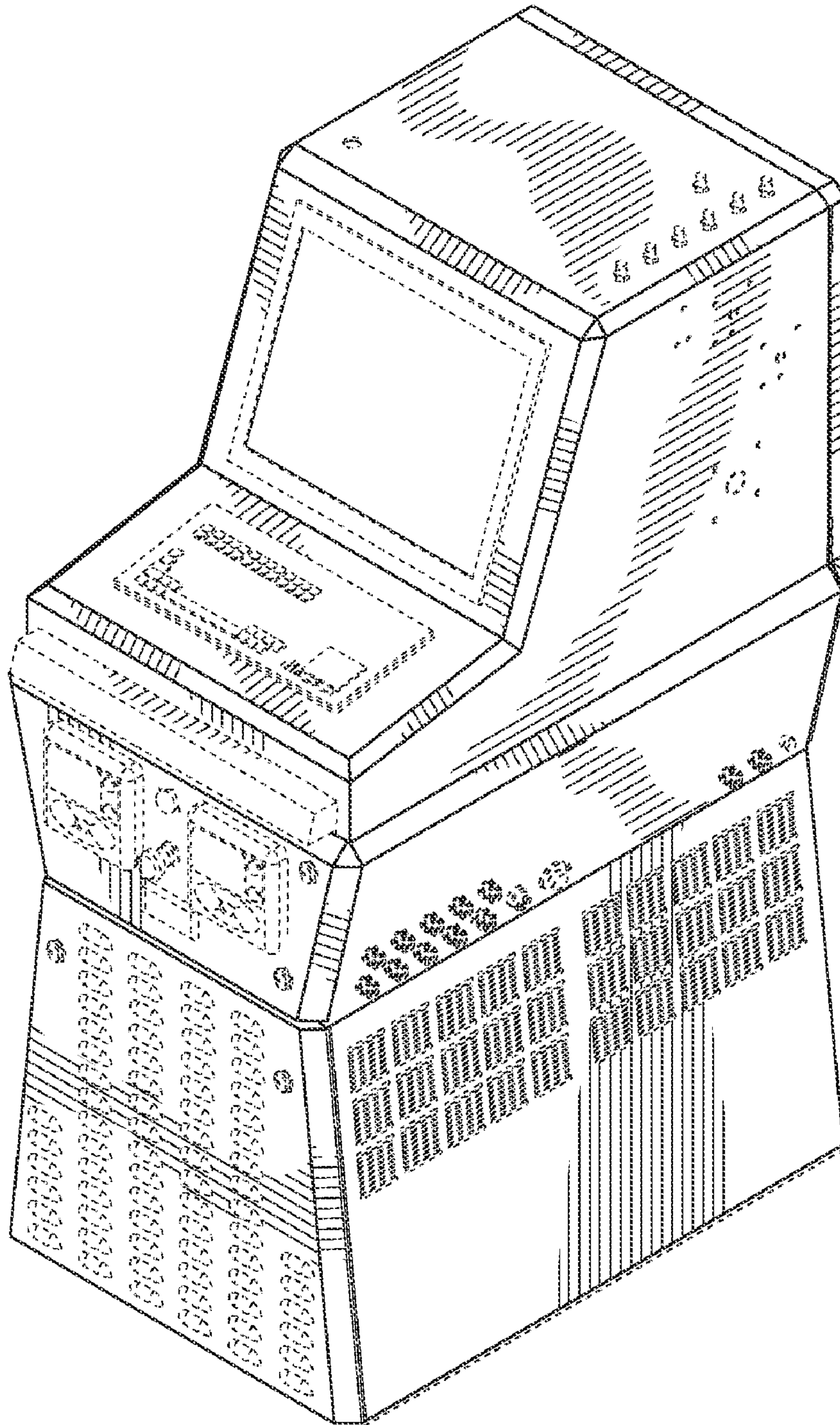

FIG. 1

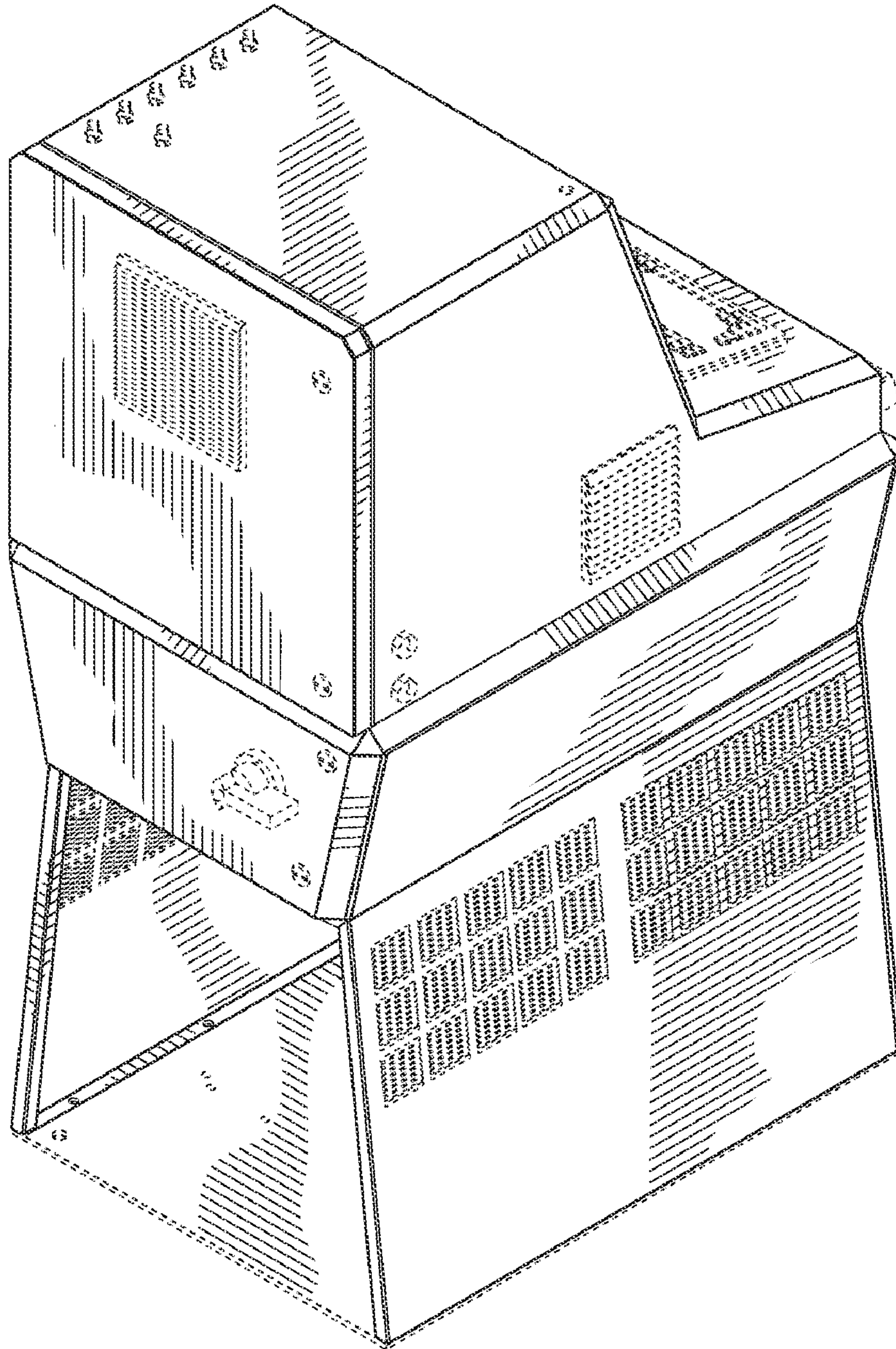

FIG. 2

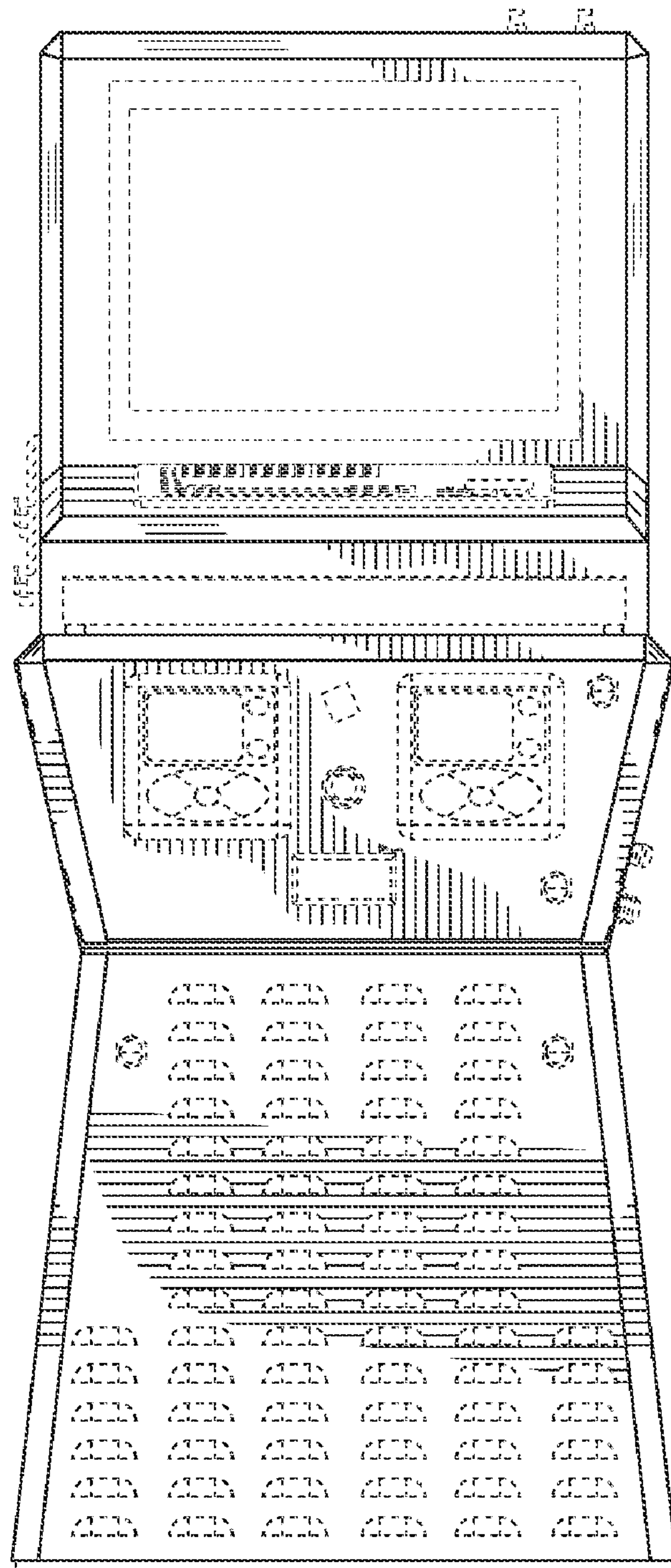

FIG. 3

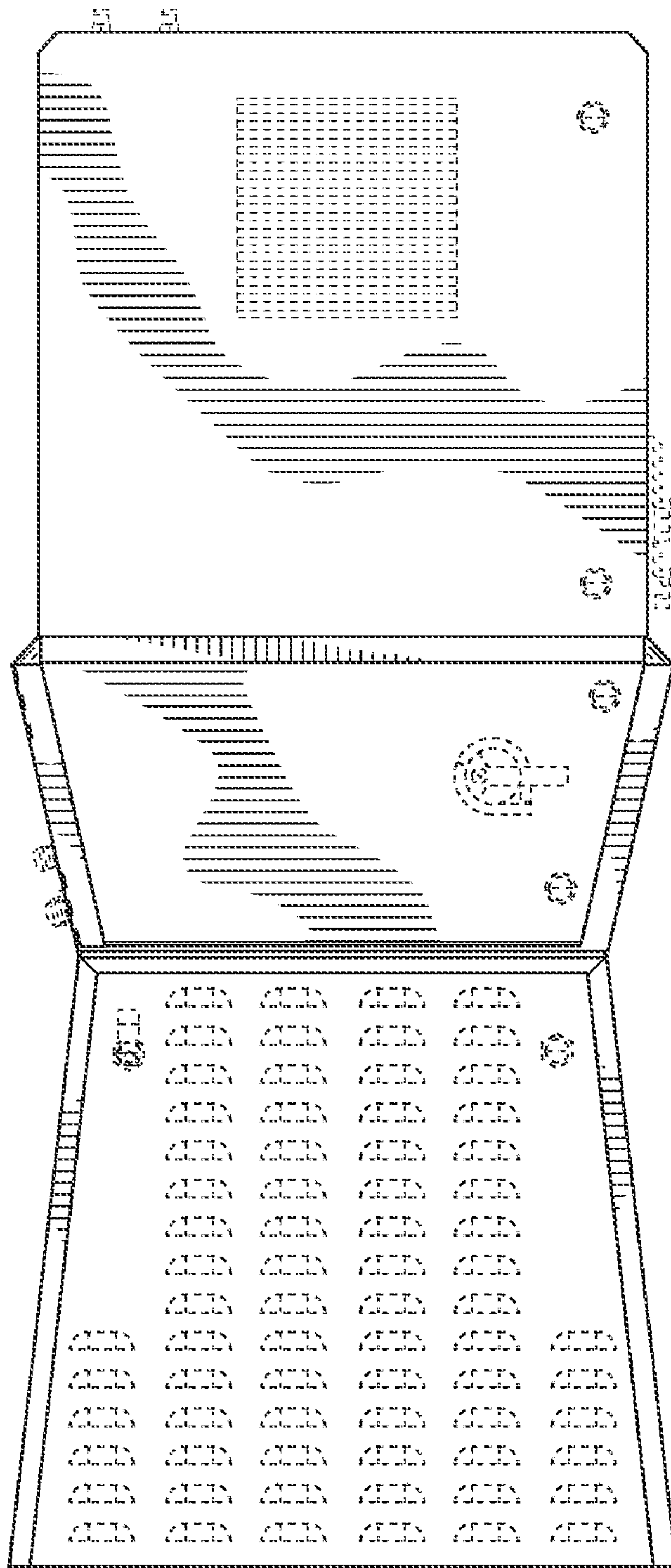

FIG. 4

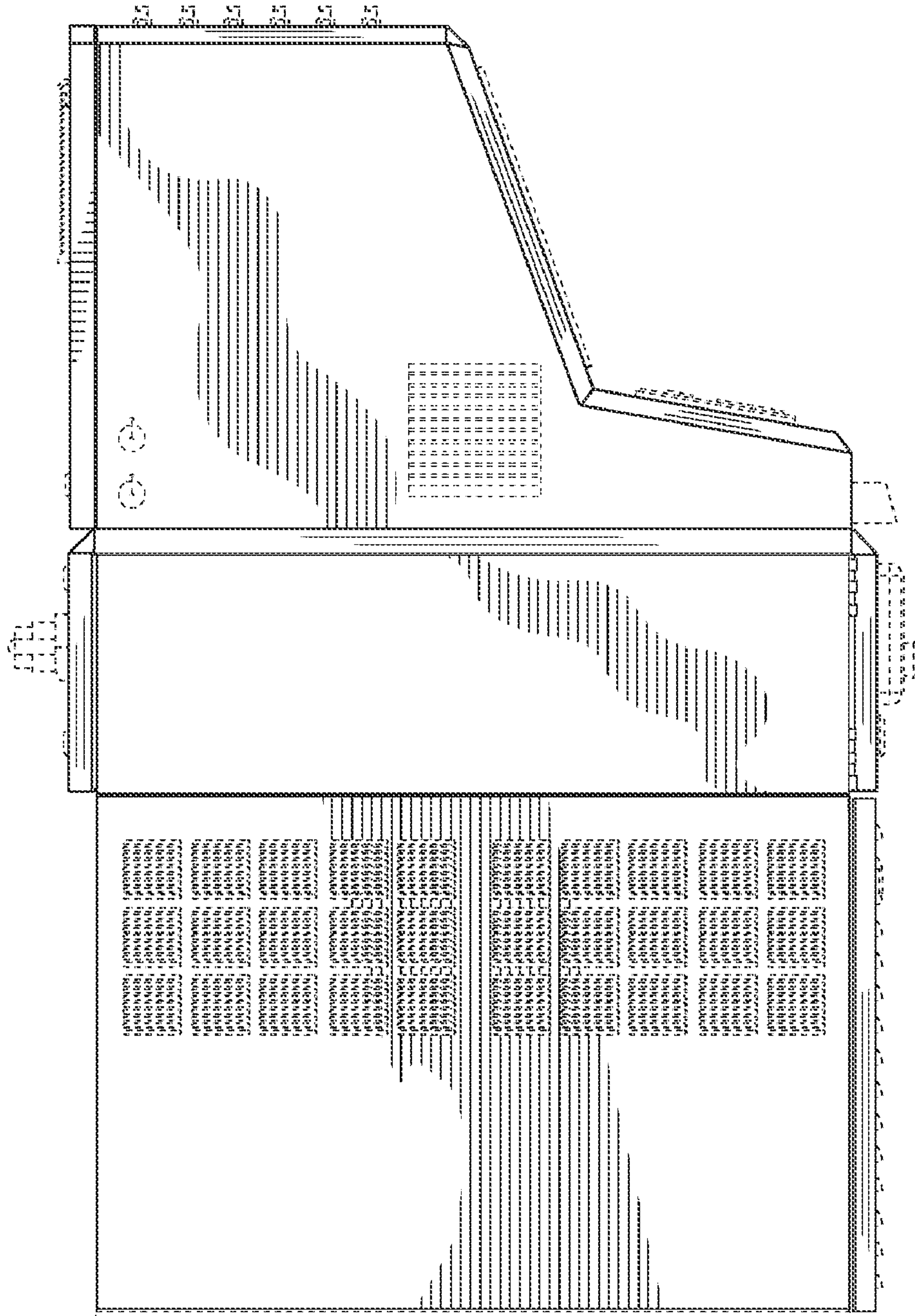

FIG. 5

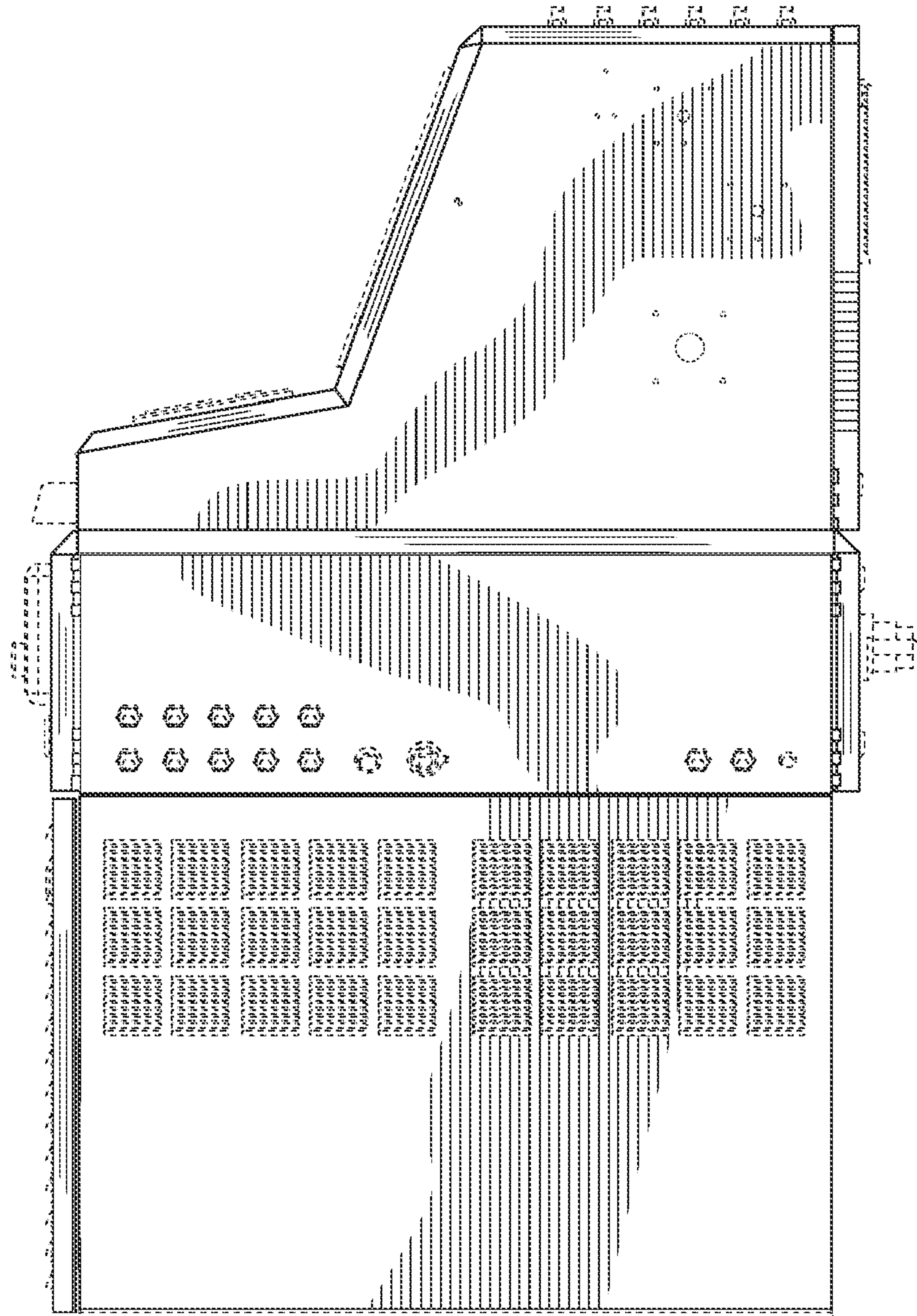

FIG. 6

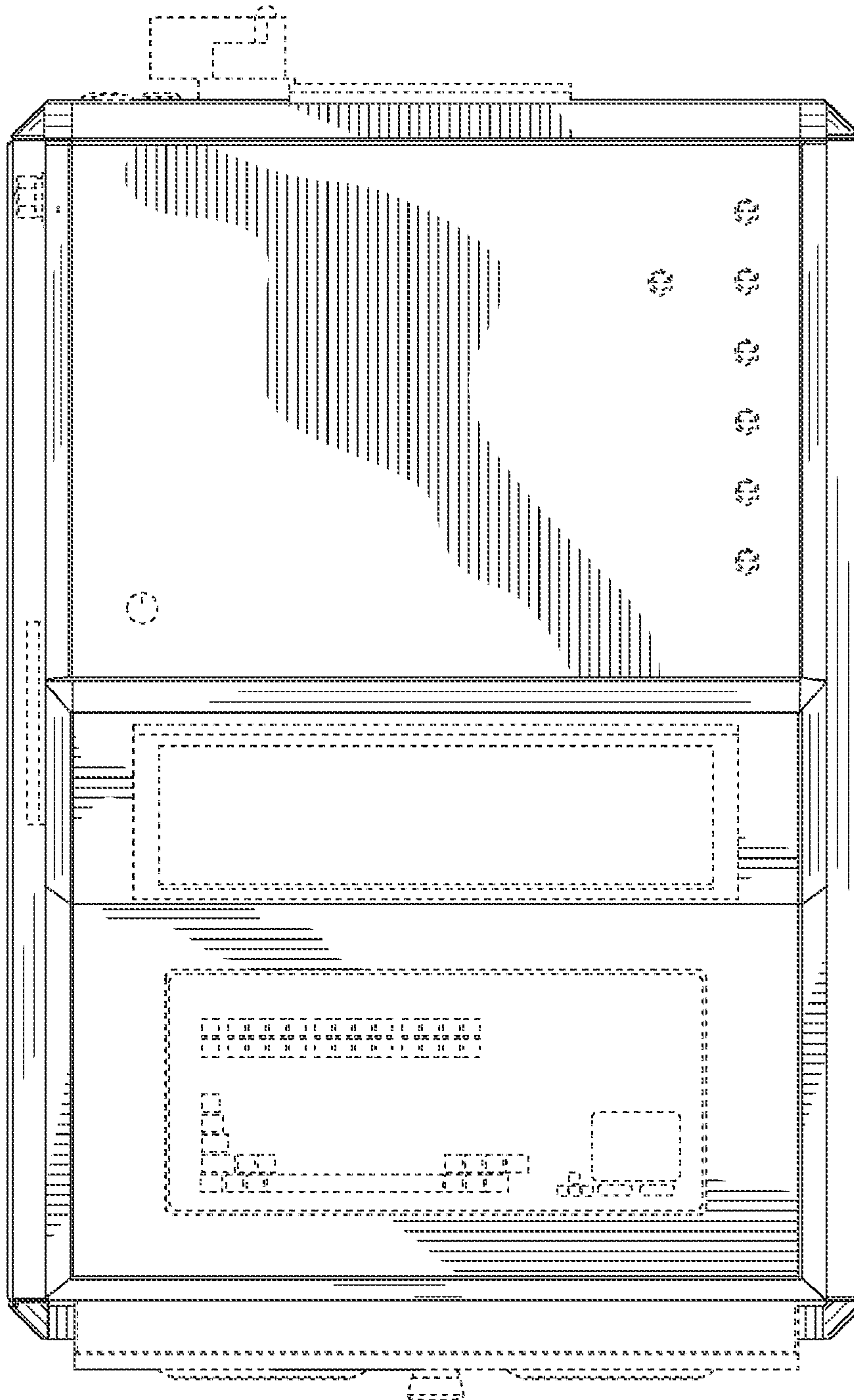

FIG. 7

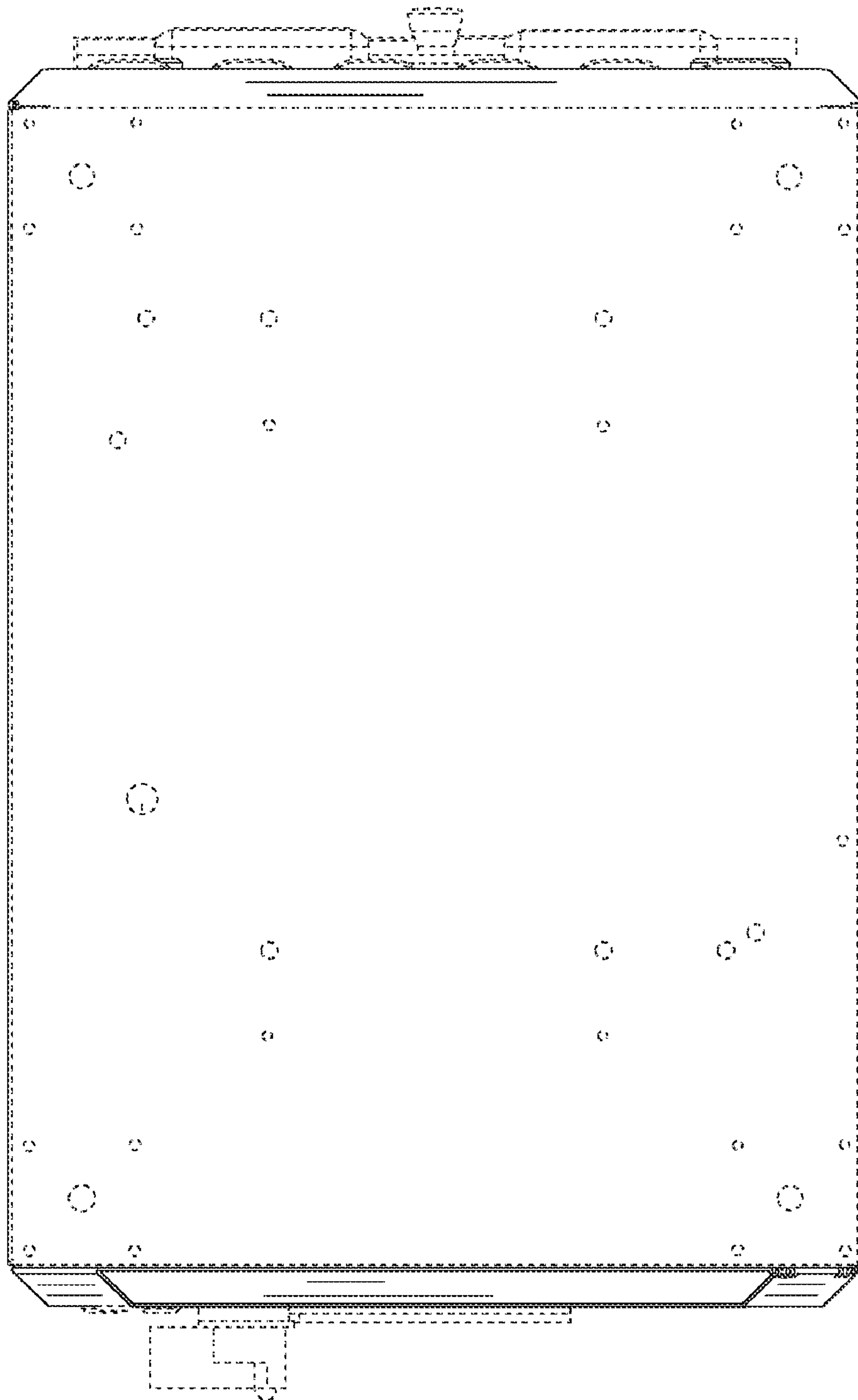

FIG. 8