



US00D625375S

(12) **United States Design Patent**
Kim et al.

(10) **Patent No.:** **US D625,375 S**
(45) **Date of Patent:** **** Oct. 12, 2010**

(54) **IRON GOLF CLUB**

D377,068 S * 12/1996 Stites, III D21/748
D618,293 S * 6/2010 Foster et al. D21/747

(75) Inventors: **Kevin Weejoung Kim**, Vista, CA (US);
Roger Cleveland, Los Angeles, CA
(US); **Matthew Myers**, San Diego, CA
(US)

* cited by examiner

Primary Examiner—Mitchell I Siegel

(74) *Attorney, Agent, or Firm*—Michael A. Catania

(73) Assignee: **Callaway Golf Company**, Carlsbad, CA
(US)

(57) **CLAIM**

(**) Term: **14 Years**

The ornamental design for an iron golf club, as shown and described.

(21) Appl. No.: **29/346,675**

(22) Filed: **Nov. 4, 2009**

DESCRIPTION

(51) **LOC (9) Cl.** **21-02**

FIG. 1 is a rear perspective view of an iron golf club head;

(52) **U.S. Cl.** **D21/748**

FIG. 2 is a front elevational view thereof;

(58) **Field of Classification Search** D21/747–751,

FIG. 3 is a top view thereof;

D21/759; 473/324–331, 350

FIG. 4 is a rear elevational view thereof;

See application file for complete search history.

FIG. 5 is a bottom plan view thereof;

(56) **References Cited**

FIG. 6 is a heel elevational view thereof; and,

U.S. PATENT DOCUMENTS

FIG. 7 is a toe elevational view thereof.

D328,483 S * 8/1992 Antonious D21/748

D330,926 S * 11/1992 Antonious D21/748

1 Claim, 2 Drawing Sheets

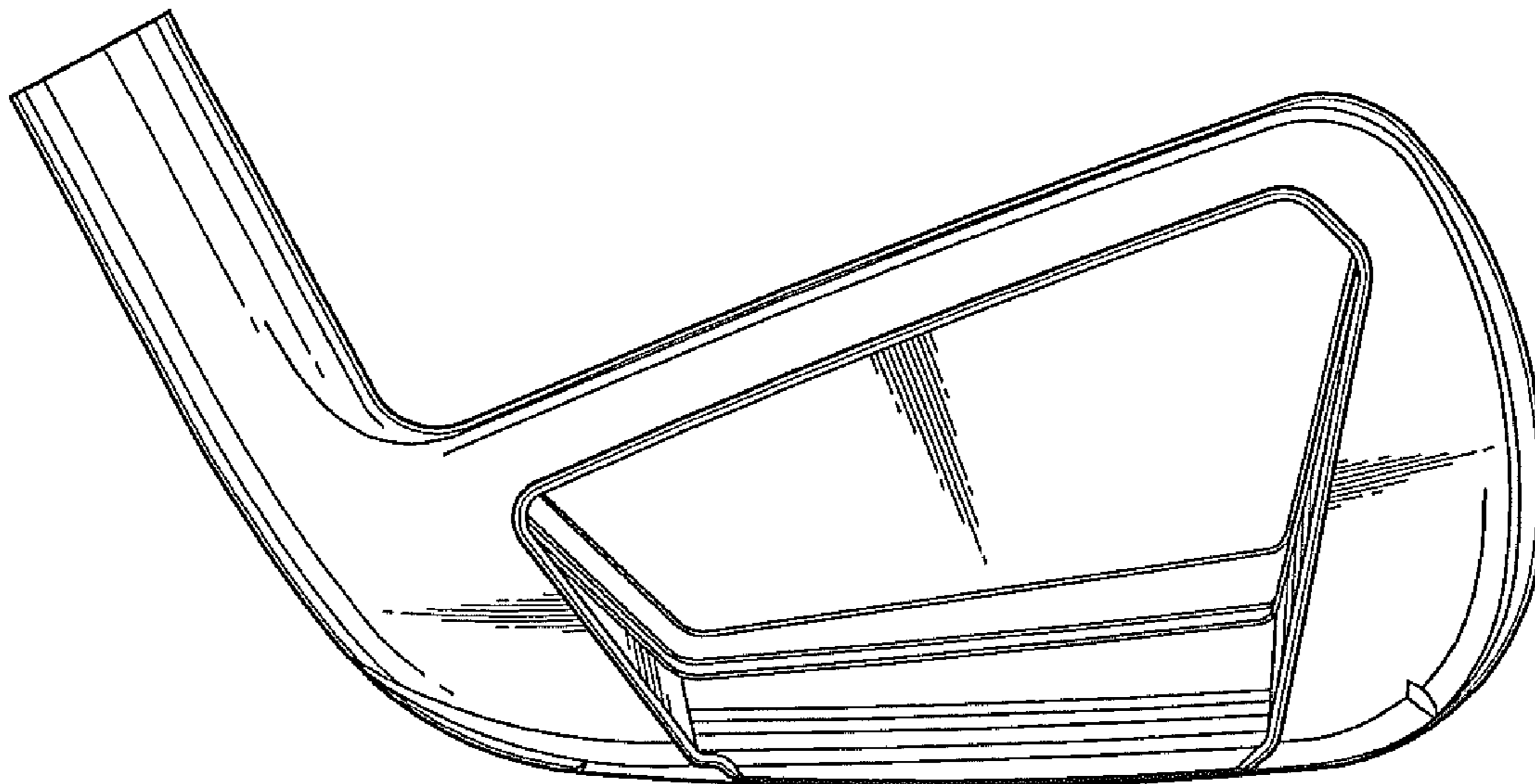

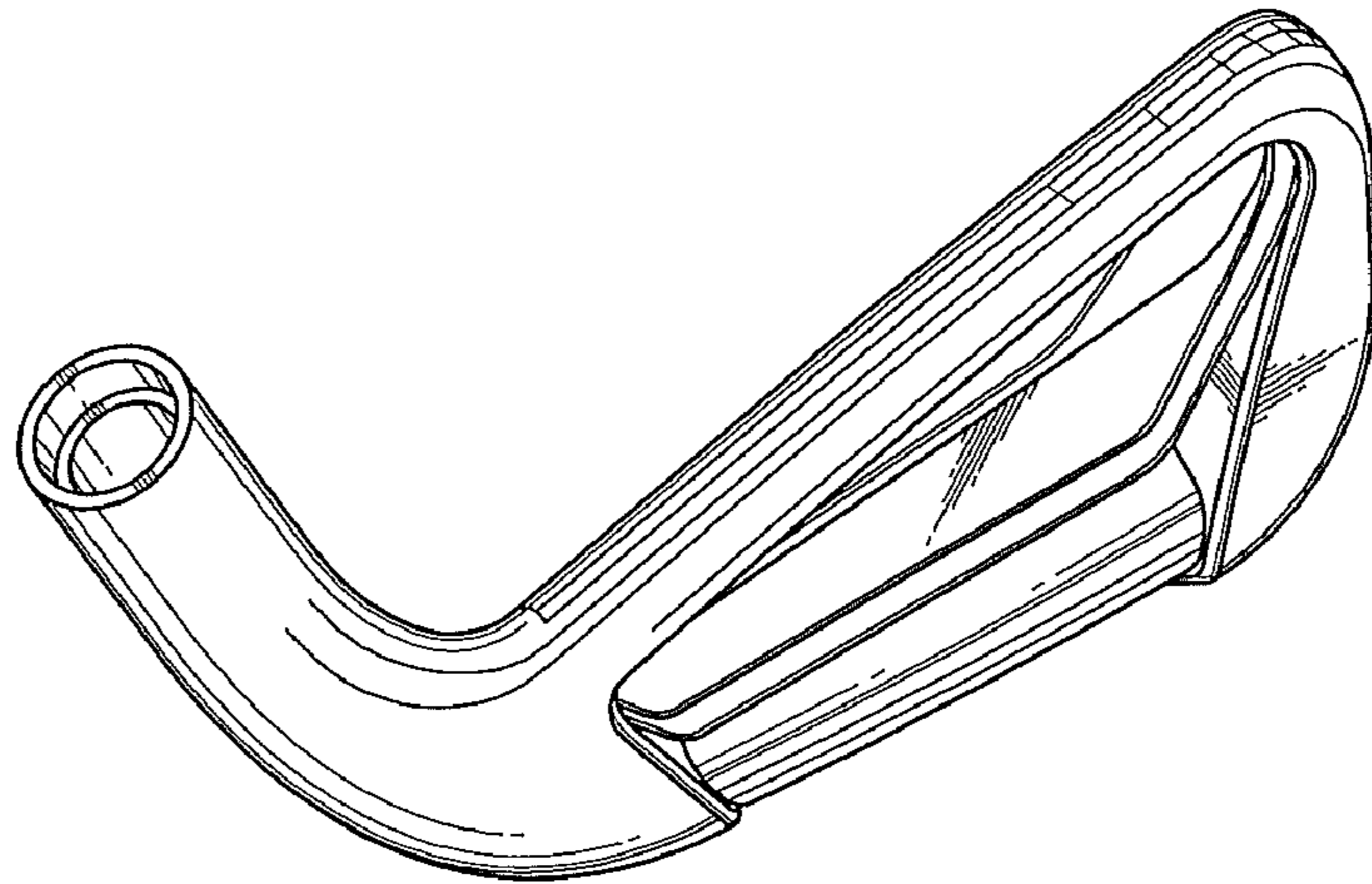

FIG. 1

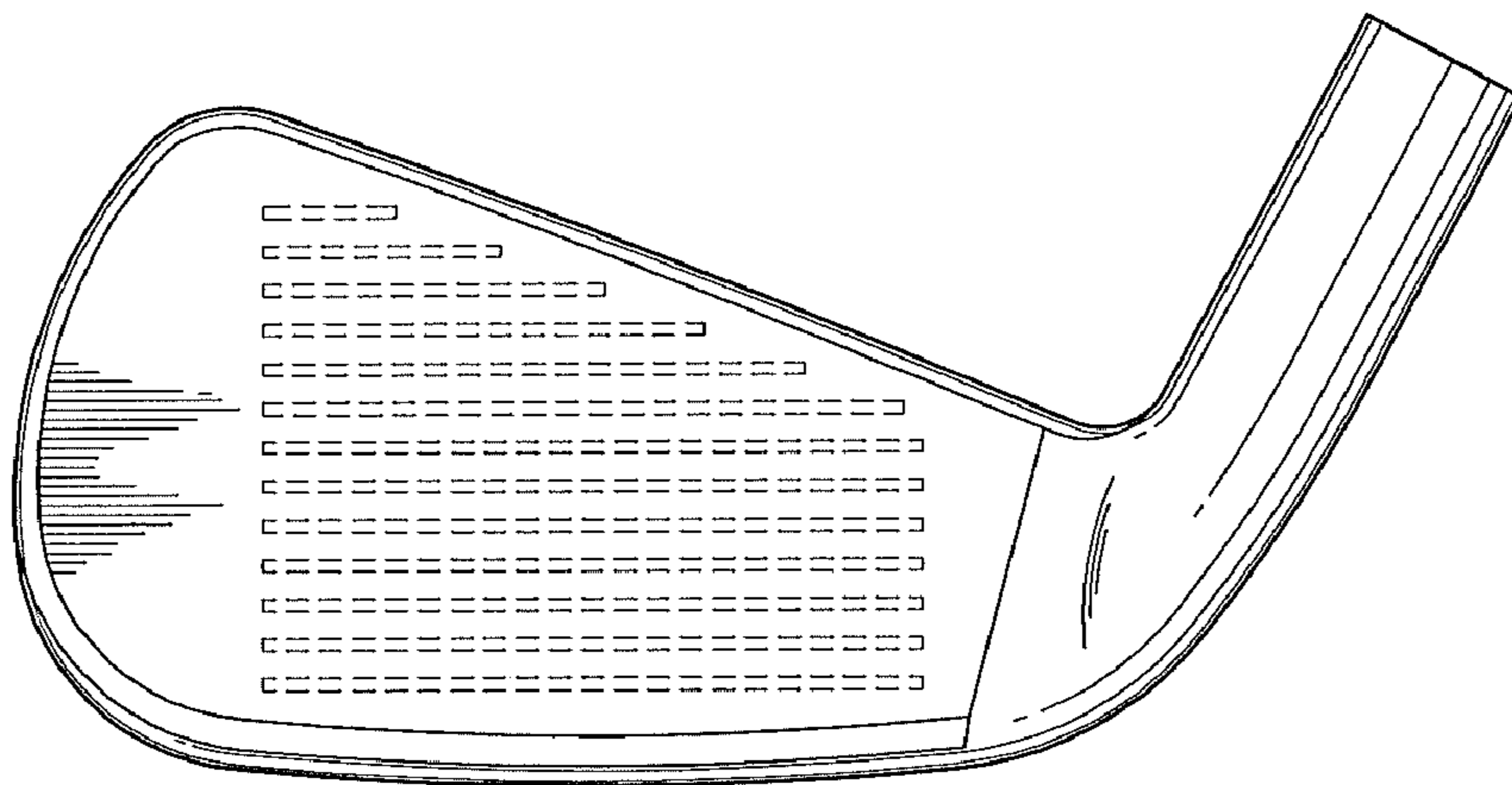

FIG. 2

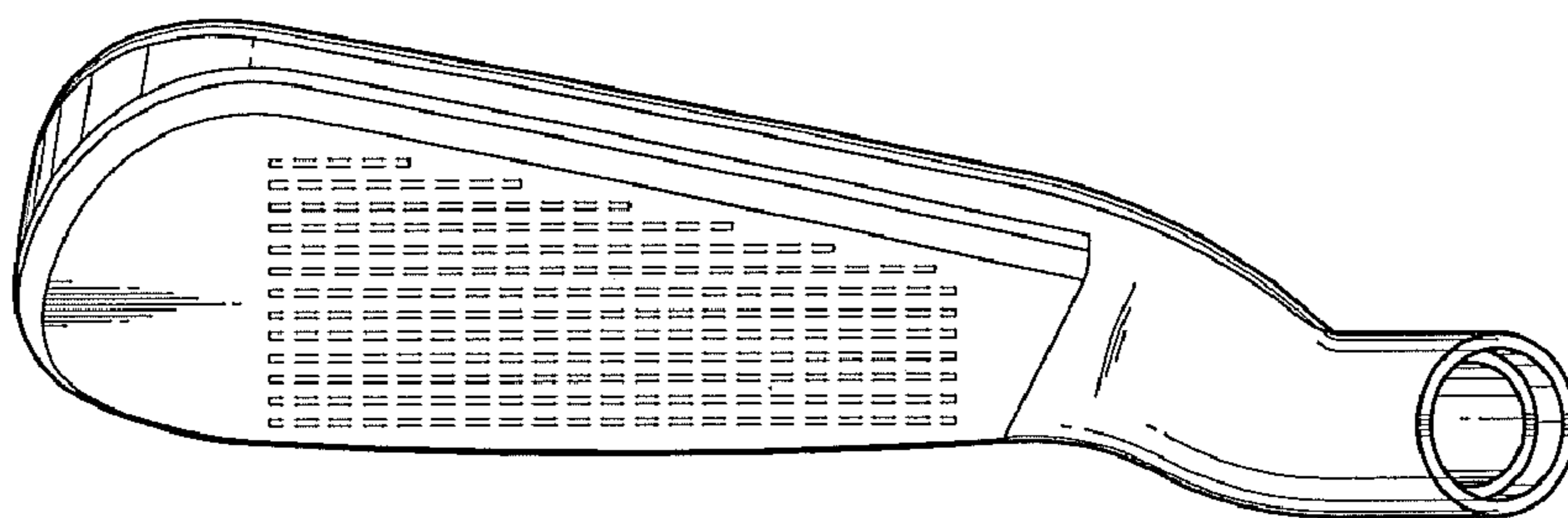

FIG. 3

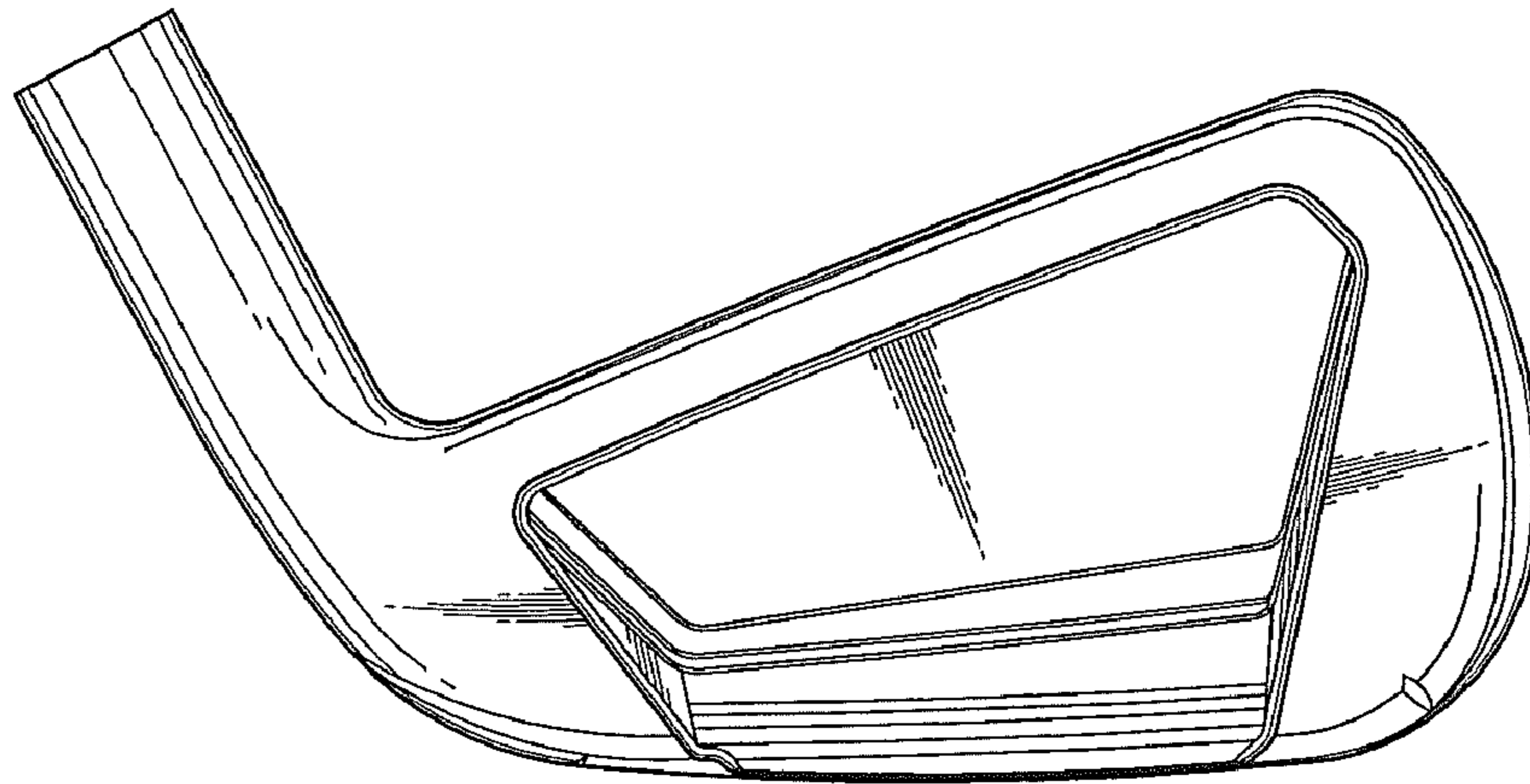

FIG. 4

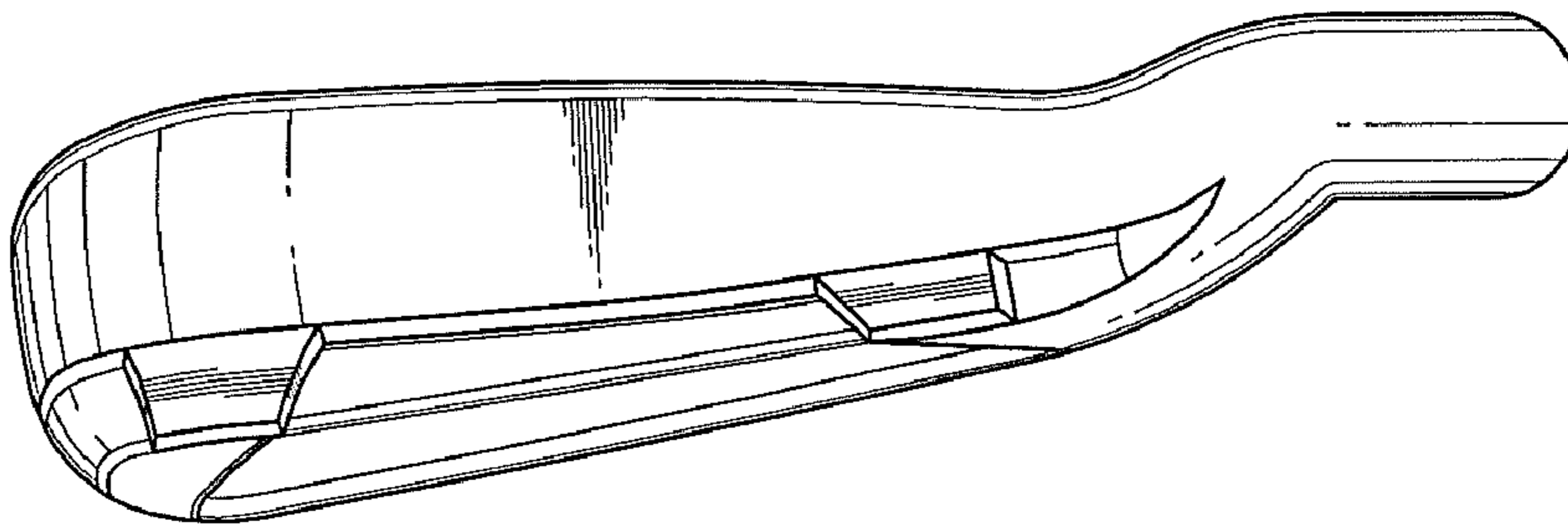

FIG. 5

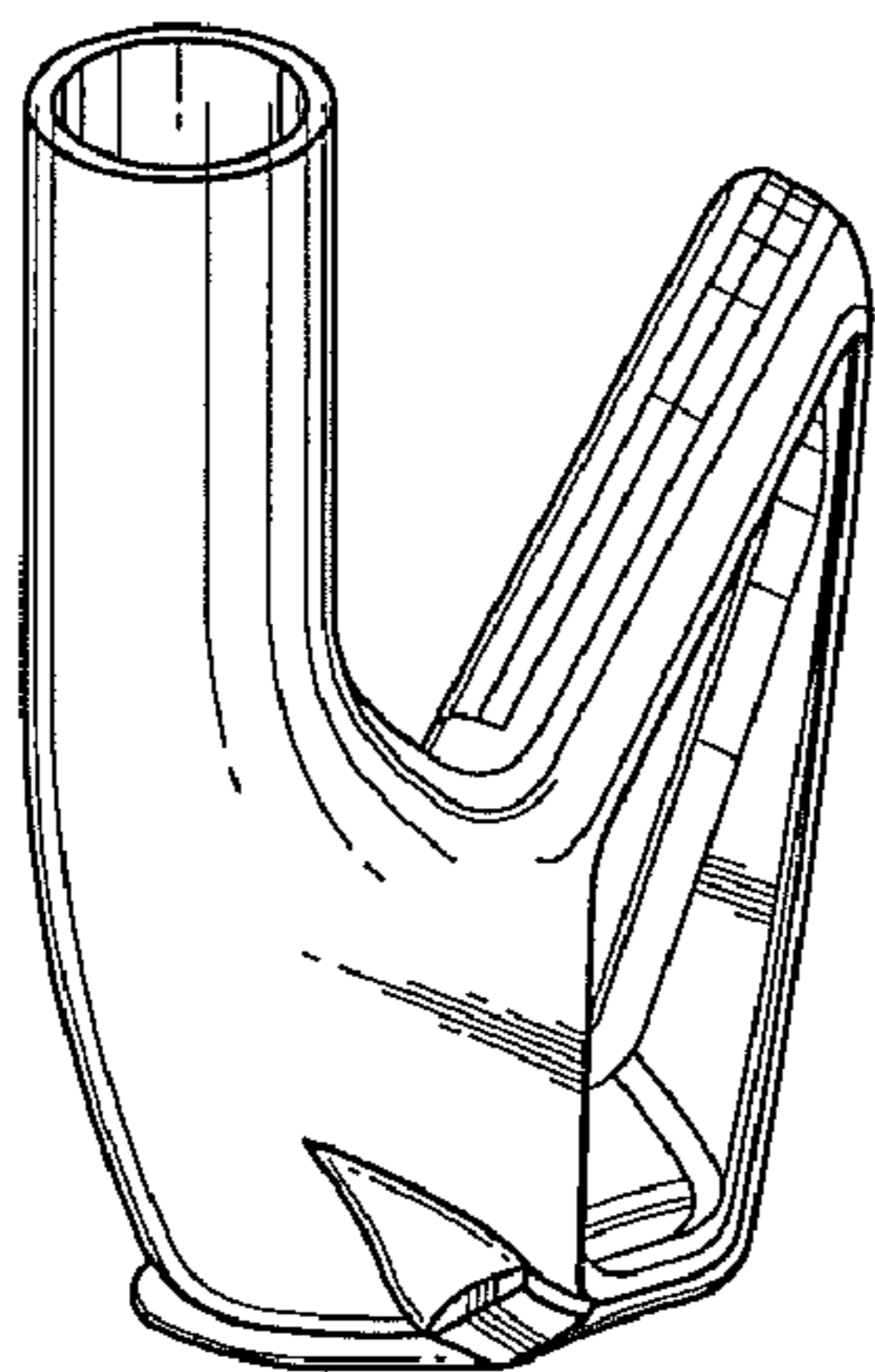

FIG. 6

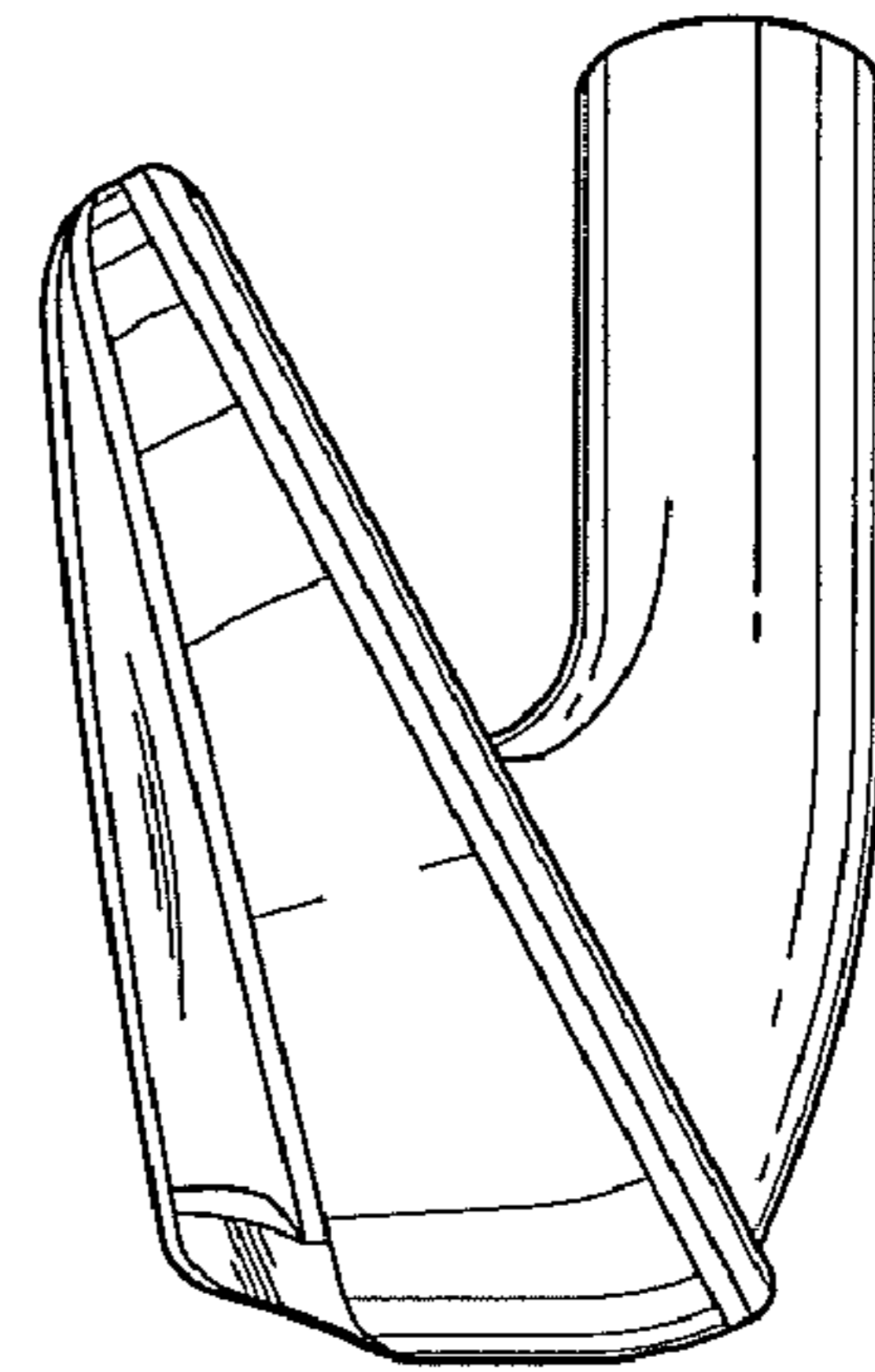

FIG. 7