



US00D625342S

(12) **United States Design Patent**  
**Seo et al.**

(10) **Patent No.:** **US D625,342 S**  
(45) **Date of Patent:** **\*\* Oct. 12, 2010**

(54) **REFRIGERATOR**

(75) Inventors: **Woon Kyu Seo**, Gyeonggi-do (KR);  
**Han Jin Jung**, Seoul (KR); **Jung Yeon Hwang**, Seoul (KR)

(73) Assignee: **LG Electronics Inc.**, Seoul (KR)

(\*\*) Term: **14 Years**

(21) Appl. No.: **29/351,906**

(22) Filed: **Dec. 14, 2009**

(30) **Foreign Application Priority Data**

Jun. 23, 2009 (KR) ..... 30-2009-0027639

(51) **LOC (9) Cl.** ..... **15-07**

(52) **U.S. Cl.** ..... **D15/85**

(58) **Field of Classification Search** ..... D15/79,  
D15/81, 85, 88; 62/3.6, 246-255, 331, 337;  
312/116, 400-408

See application file for complete search history.

(56) **References Cited**

**U.S. PATENT DOCUMENTS**

D379,095 S \* 5/1997 Sparks ..... D15/85  
D525,993 S \* 8/2006 Kim et al. .... D15/85  
D527,395 S \* 8/2006 Kim ..... D15/85  
D527,745 S \* 9/2006 Kim et al. .... D15/85  
D527,748 S \* 9/2006 Kim ..... D15/85

D528,135 S \* 9/2006 Kim et al. .... D15/85  
D555,177 S \* 11/2007 Yeo et al. .... D15/85  
D555,178 S \* 11/2007 Yeo et al. .... D15/85  
D568,343 S \* 5/2008 Suh et al. .... D15/85  
D570,884 S \* 6/2008 Yang et al. .... D15/86  
D601,175 S \* 9/2009 Staud et al. .... D15/85  
D603,429 S \* 11/2009 Lee et al. .... D15/85  
D613,314 S \* 4/2010 Staud ..... D15/81

\* cited by examiner

*Primary Examiner*—Shanda C Hill

(74) *Attorney, Agent, or Firm*—Morgan Lewis & Bockius LLP

(57) **CLAIM**

We claim the ornamental design for a refrigerator, as shown and described.

**DESCRIPTION**

FIG. 1 is a perspective view of a refrigerator showing our new design:

FIG. 2 is a front elevation view thereof;

FIG. 3 is a rear elevation view thereof;

FIG. 4 is a left-side elevation view thereof;

FIG. 5 is a right-side elevation view thereof;

FIG. 6 is a top plan view thereof; and,

FIG. 7 is a bottom plan view thereof.

**1 Claim, 6 Drawing Sheets**

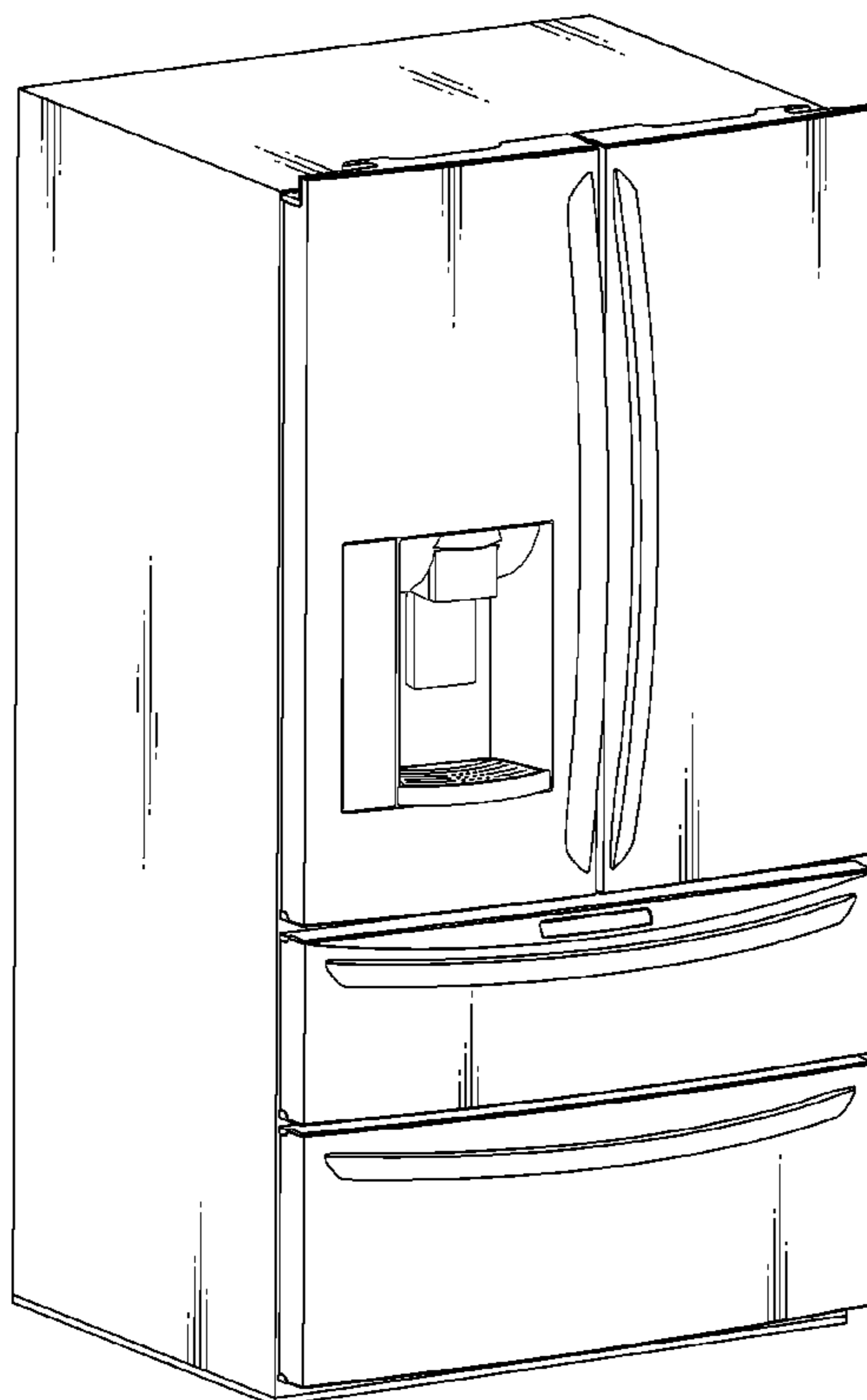

FIG. 1

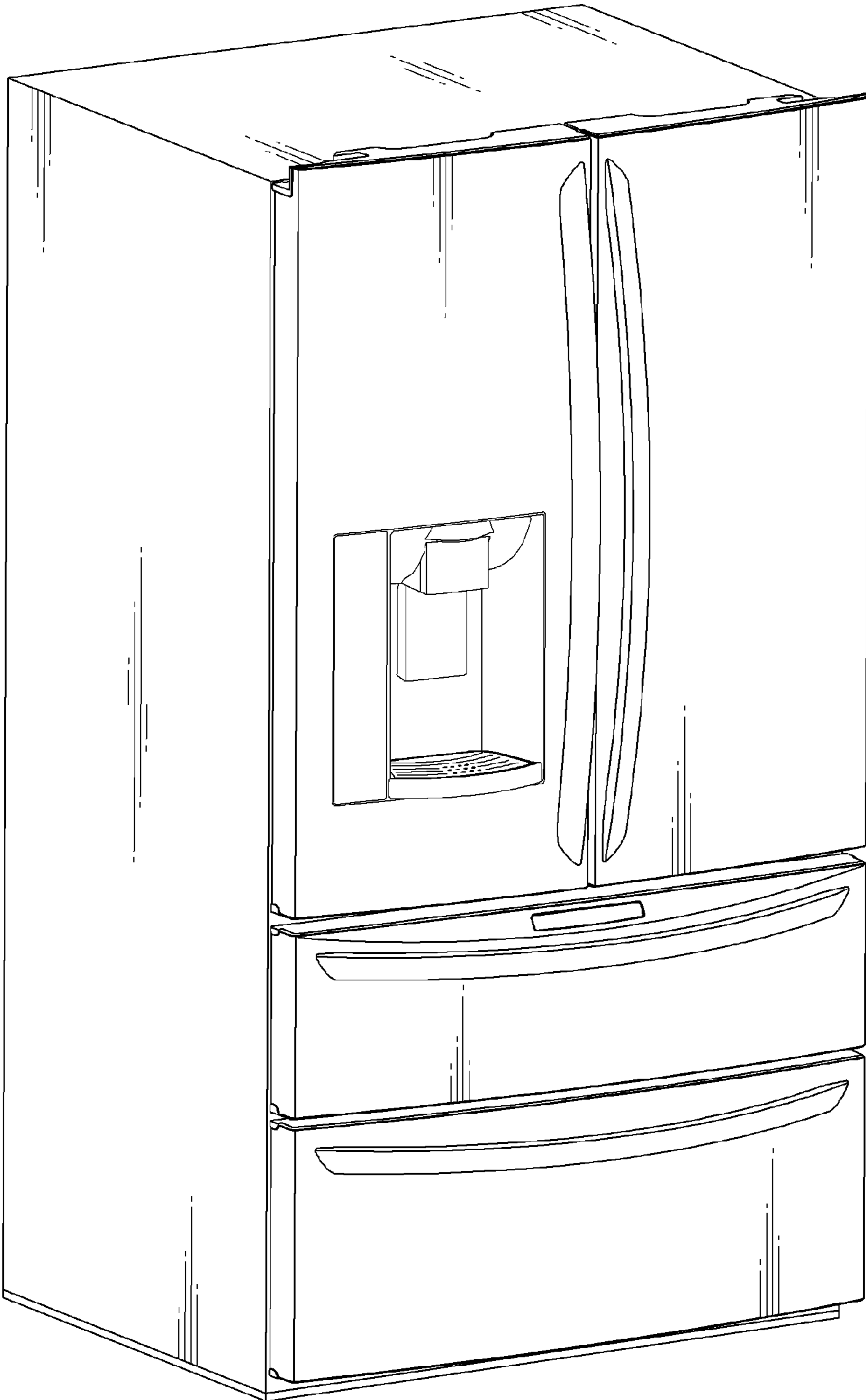

FIG. 2

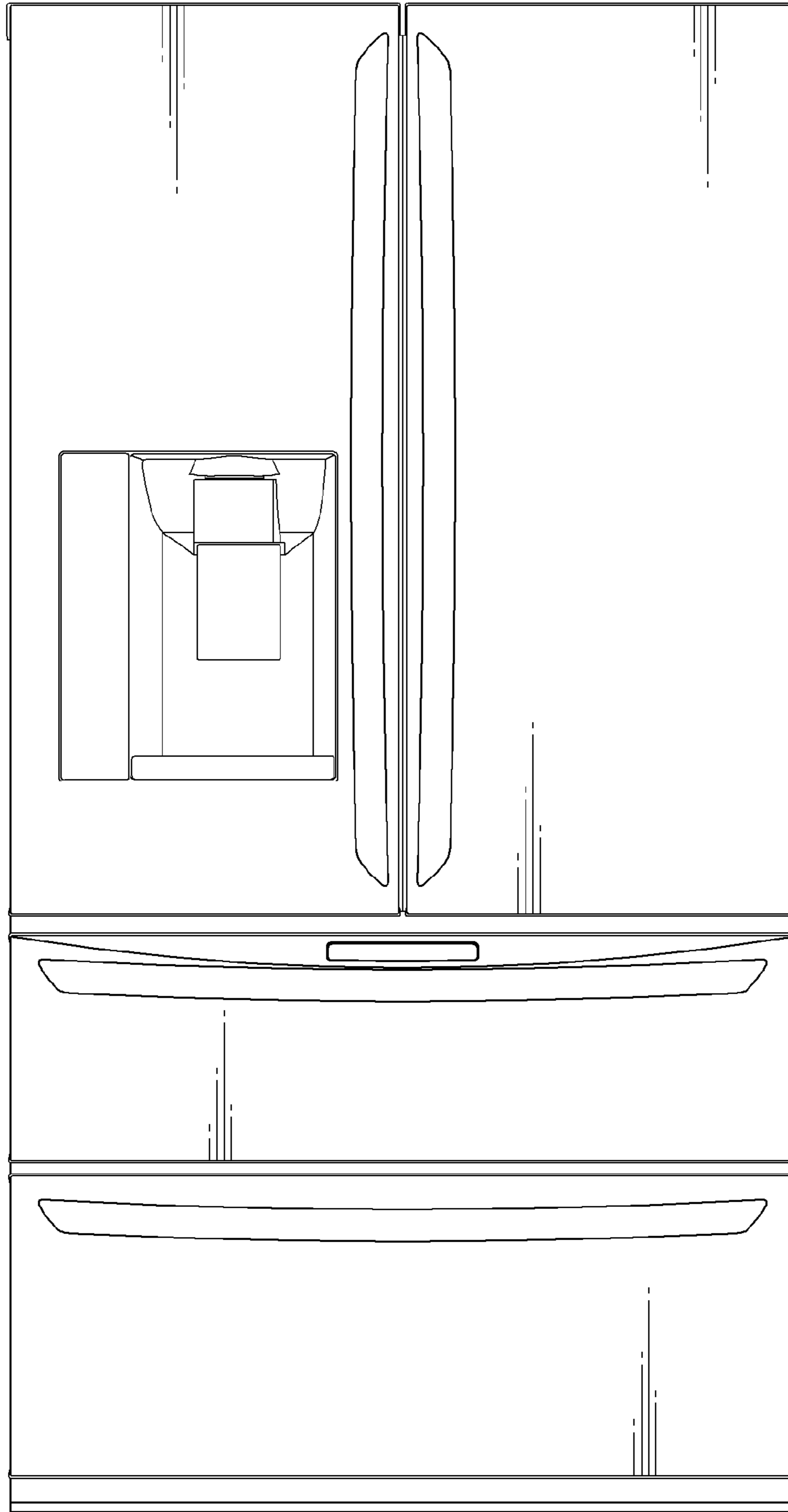

FIG. 3

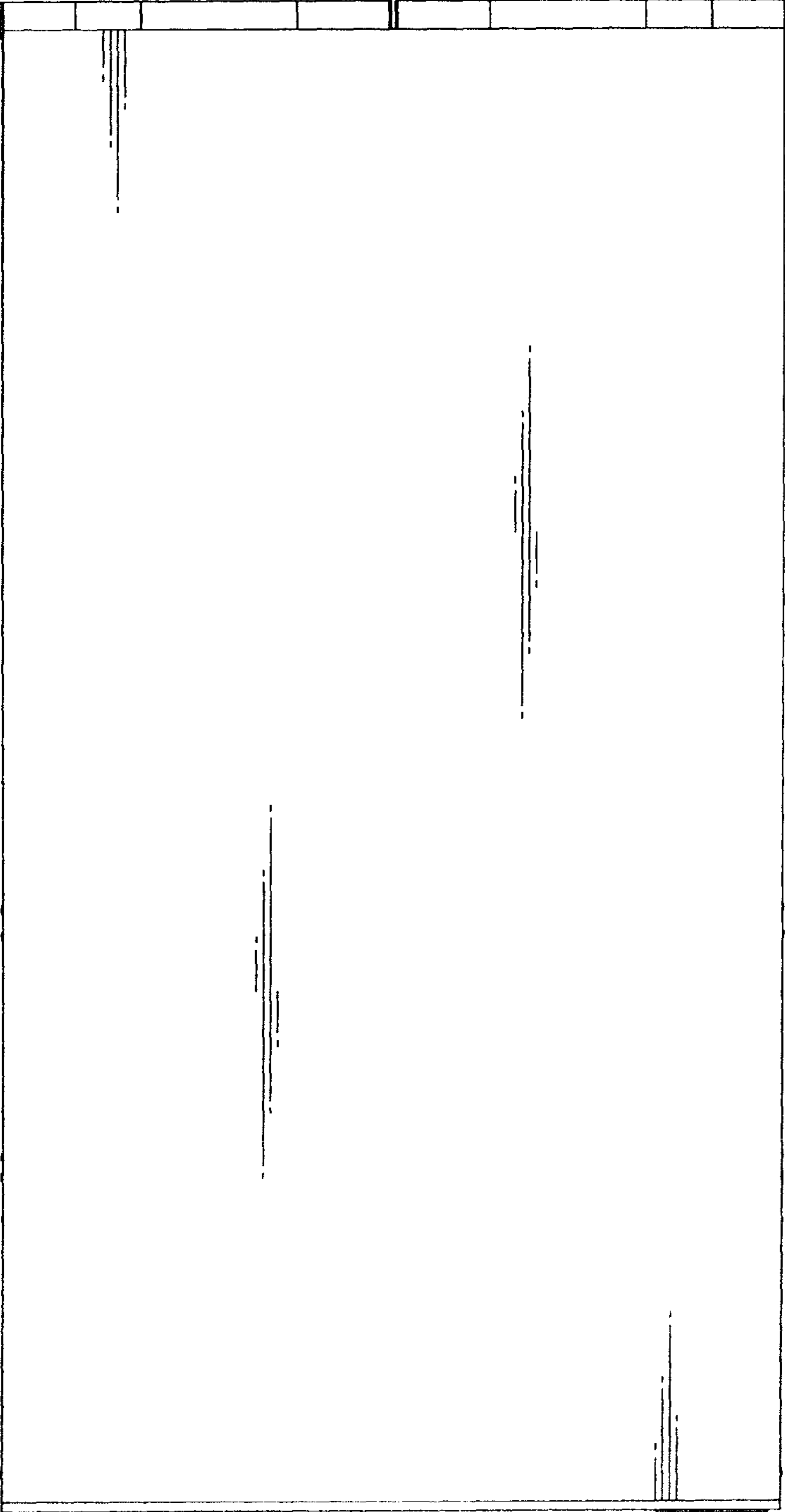

FIG. 4

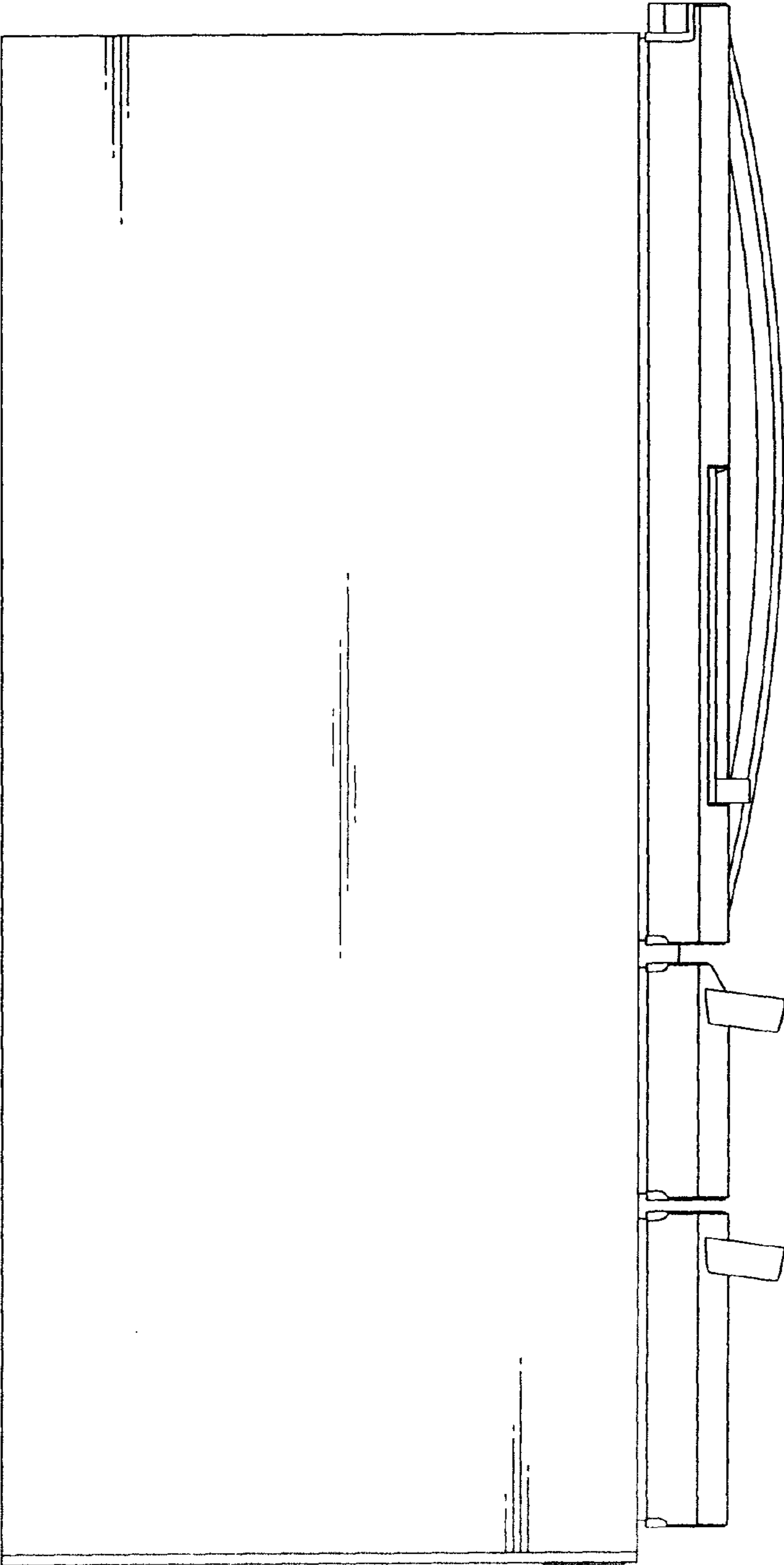

FIG. 5

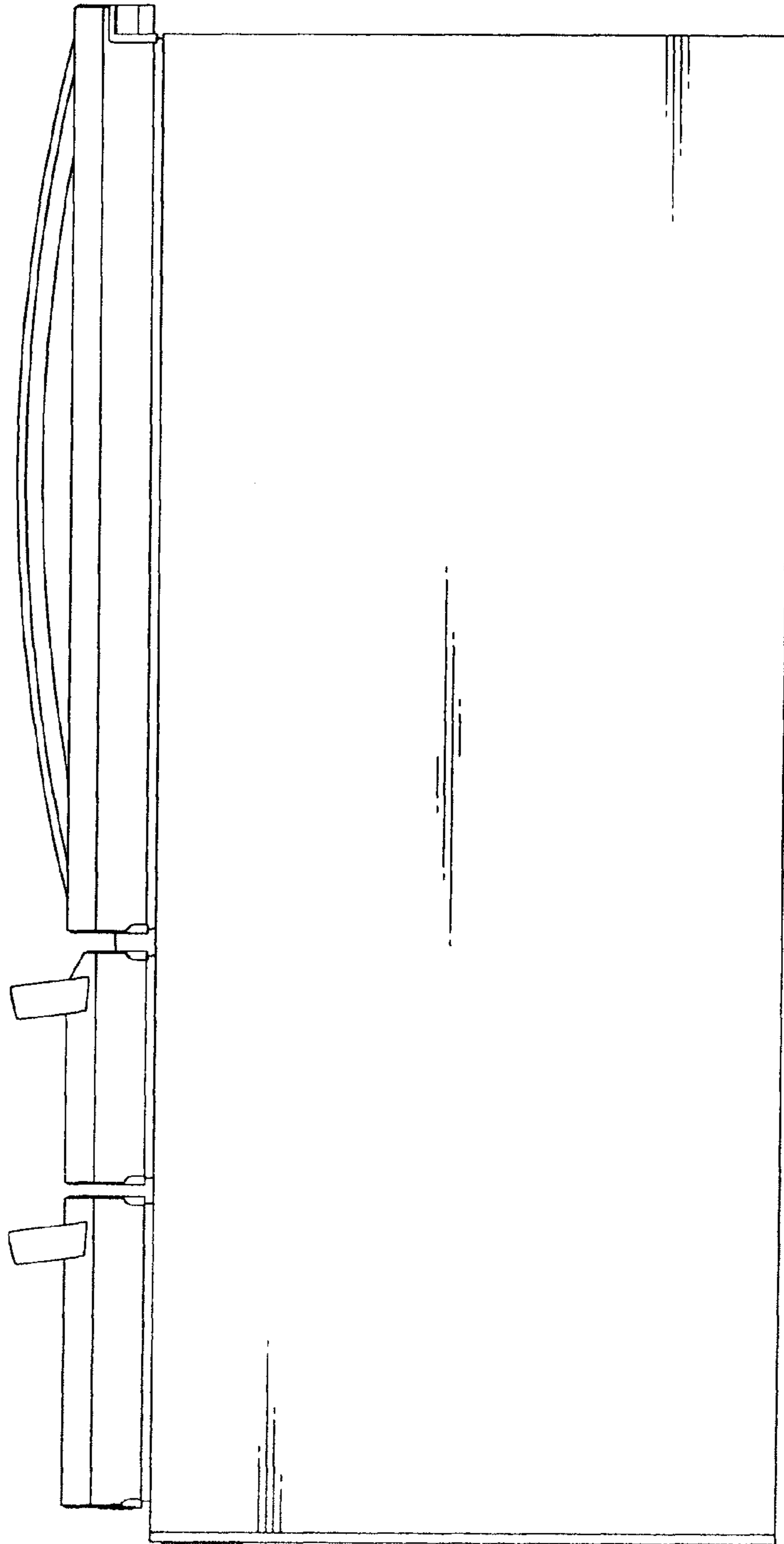

FIG. 6

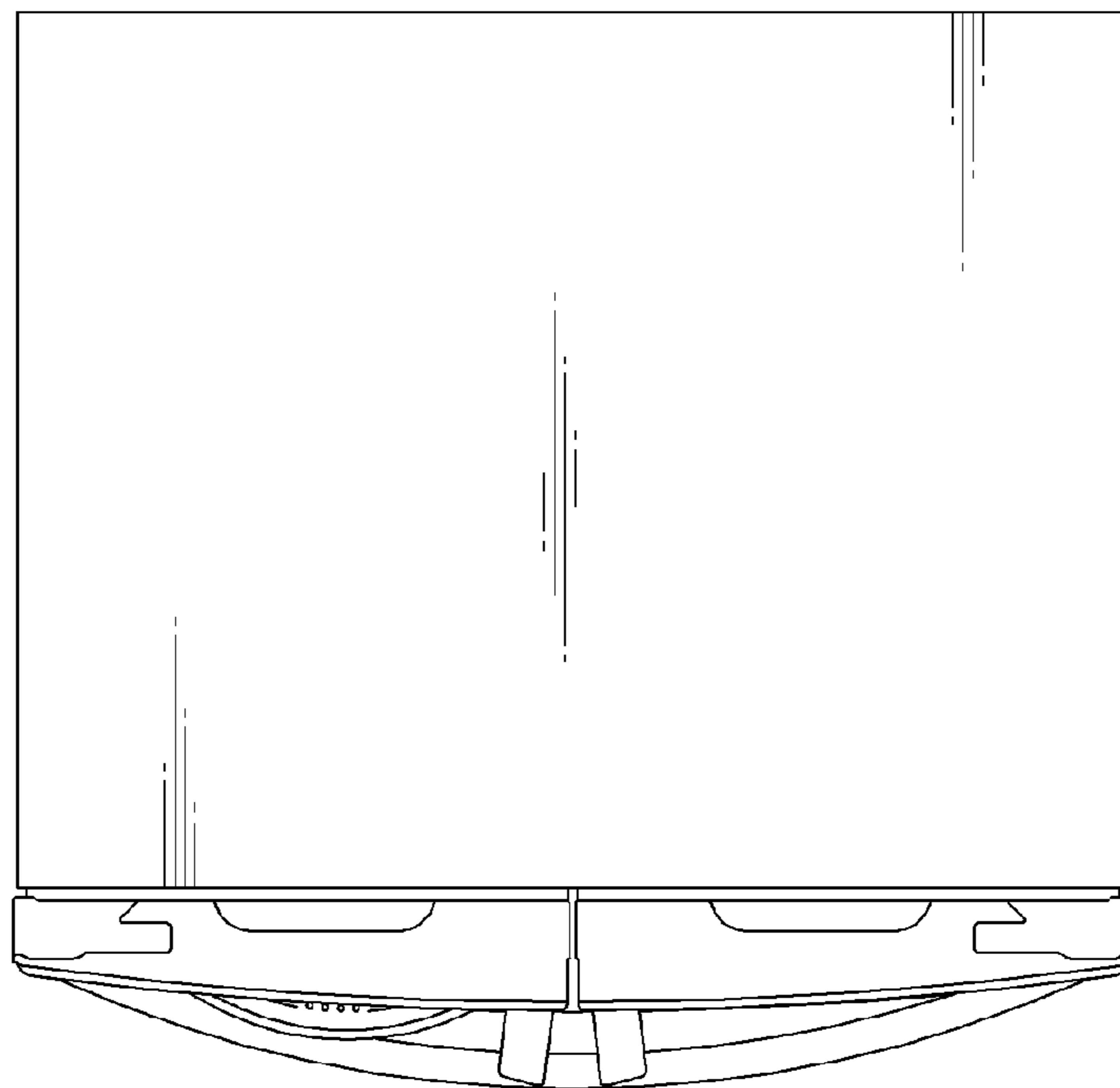

FIG. 7

