



US00D625338S

(12) **United States Design Patent**
Nam et al.

(10) **Patent No.:** **US D625,338 S**

(45) **Date of Patent:** **** Oct. 12, 2010**

(54) **COMPRESSOR COVER FOR AUTOMOBILES**

(75) Inventors: **Nam Taek Nam**, Busan (KR); **Jung Ho Lee**, Gyeongsangnam-Do (KR)

(73) Assignee: **Y. K. Co., Ltd.**, Kimhae (KR)

(**) Term: **14 Years**

(21) Appl. No.: **29/357,603**

(22) Filed: **Mar. 15, 2010**

(51) **LOC (9) Cl.** **15-02**

(52) **U.S. Cl.** **D15/9**

(58) **Field of Classification Search** D15/7-9;
D23/231, 232; 417/415-416, 321, 405, 265
See application file for complete search history.

(56) **References Cited**

U.S. PATENT DOCUMENTS

D282,471 S	*	2/1986	Bearint et al.	D15/9
D417,266 S	*	11/1999	Ito et al.	D23/325
D428,978 S	*	8/2000	Ito et al.	D23/325
D441,377 S	*	5/2001	Kawaguchi et al.	D15/9
D462,364 S	*	9/2002	Fujita et al.	D15/9
D466,526 S	*	12/2002	Fujii et al.	D15/9
D537,452 S	*	2/2007	Chu	D15/9
D540,823 S	*	4/2007	An	D15/9
D555,174 S	*	11/2007	Hwang	D15/9

D555,670 S	*	11/2007	Hwang	D15/9
D603,876 S	*	11/2009	Chu	D15/9
D630,877	*	11/2009	Chu	D15/9
D617,348 S	*	6/2010	Chu	D15/9

* cited by examiner

Primary Examiner—T. Chase Nelson

Assistant Examiner—Ania K Dworzecka

(74) *Attorney, Agent, or Firm*—Ladas & Parry LLP

(57) **CLAIM**

We claim the ornamental design for a compressor cover for automobiles, as shown.

DESCRIPTION

FIG. 1 is a front/right-side/top perspective view of a compressor cover for automobiles showing our new design;

FIG. 2 is a front-side elevational view thereof;

FIG. 3 is a rear-side elevational view thereof;

FIG. 4 is a left-side elevational view thereof;

FIG. 5 is a right-side elevational view thereof;

FIG. 6 is a top-side elevational view thereof; and

FIG. 7 is a bottom-side elevational view thereof; and,

FIG. 8 is a front/right-side/top perspective view thereof opened.

1 Claim, 8 Drawing Sheets

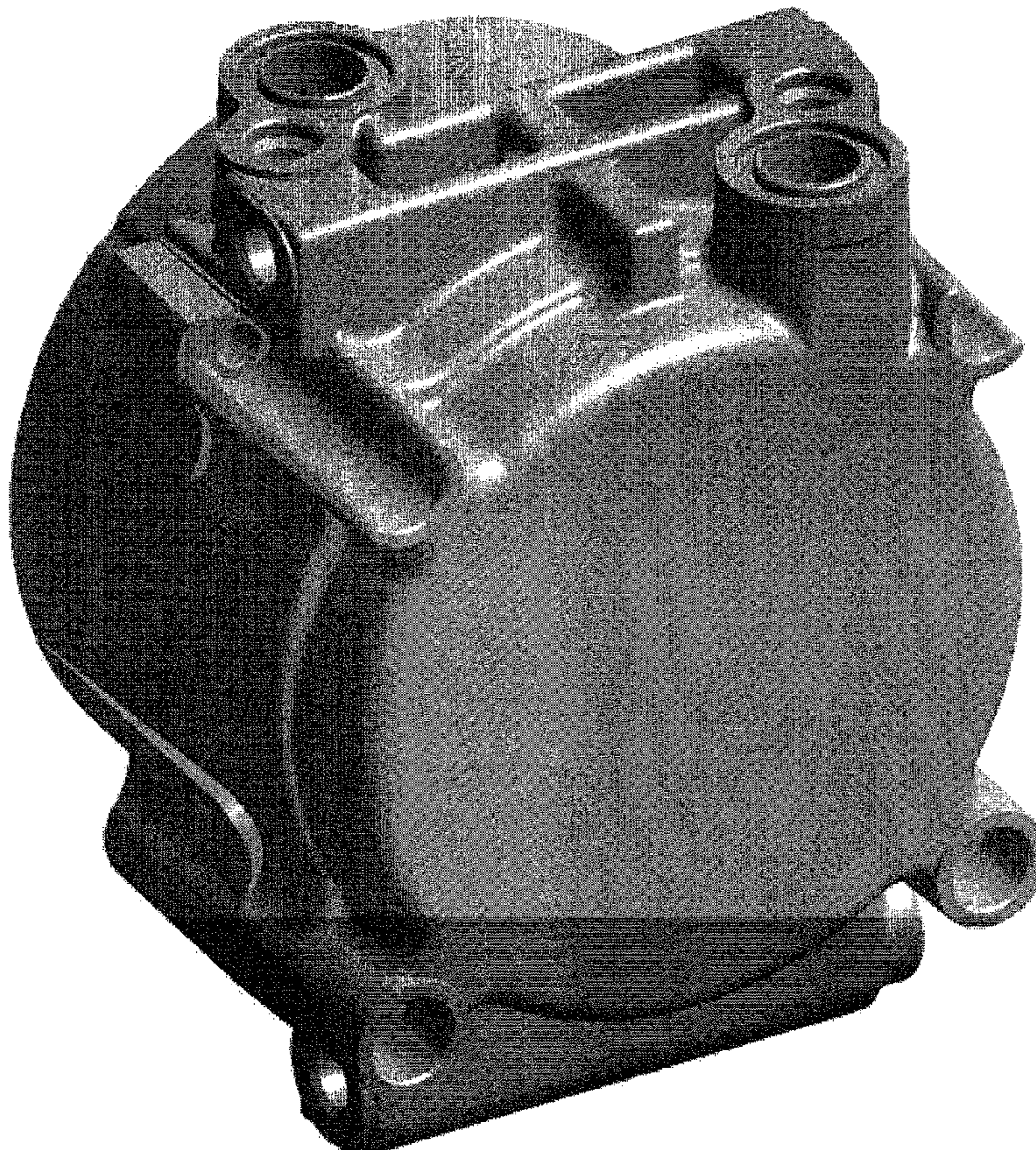

FIG. 1

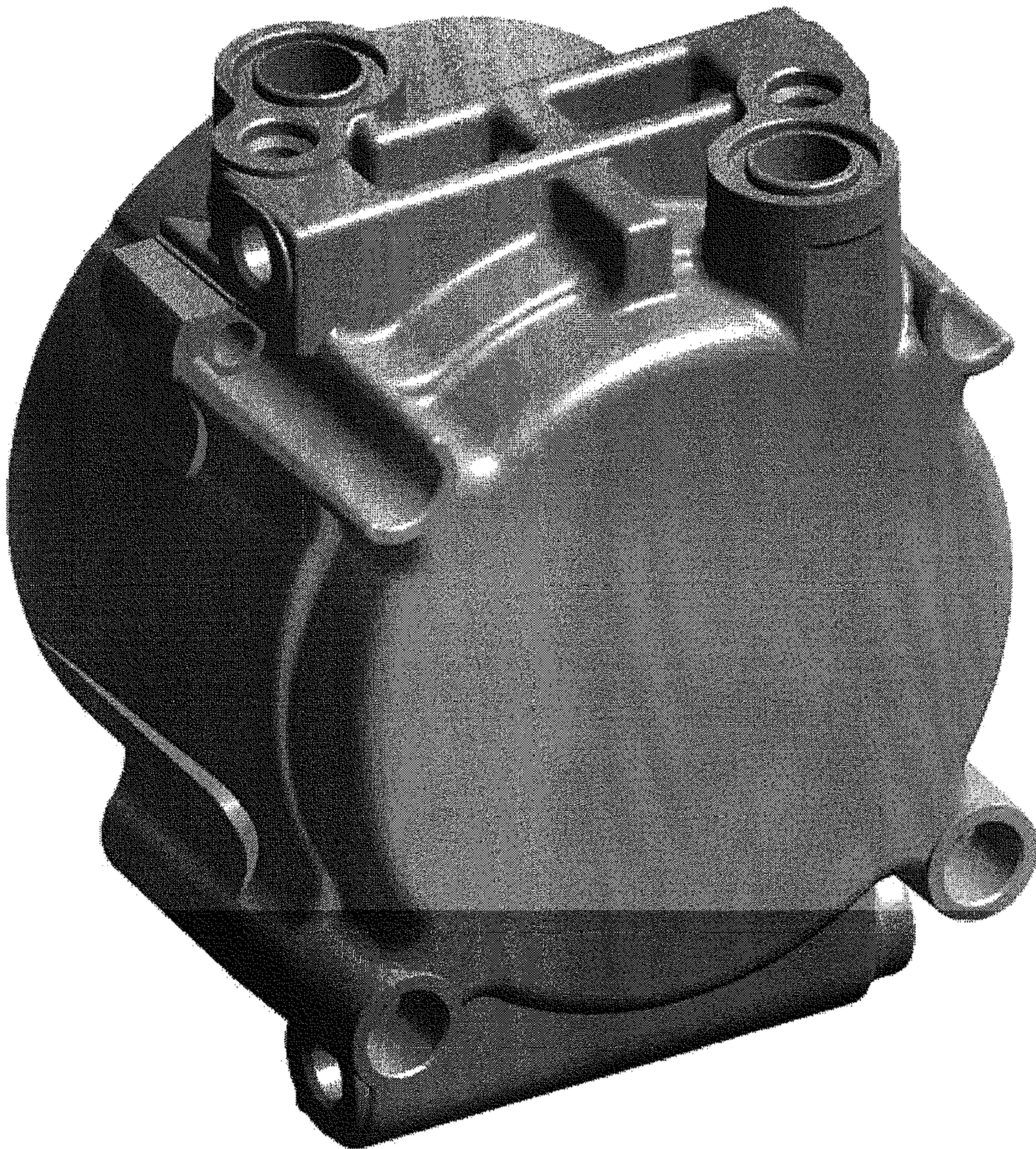

FIG. 2

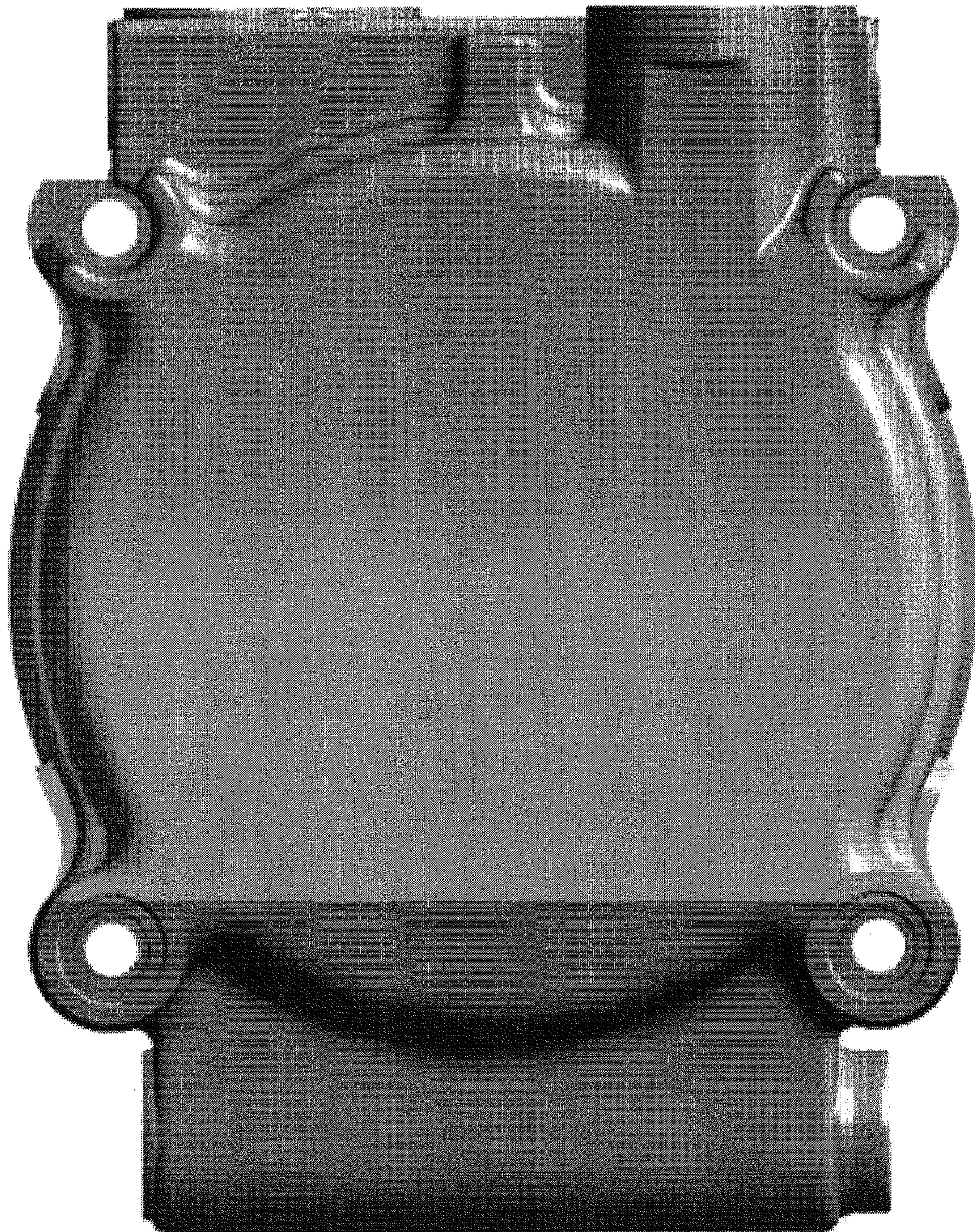

FIG. 3

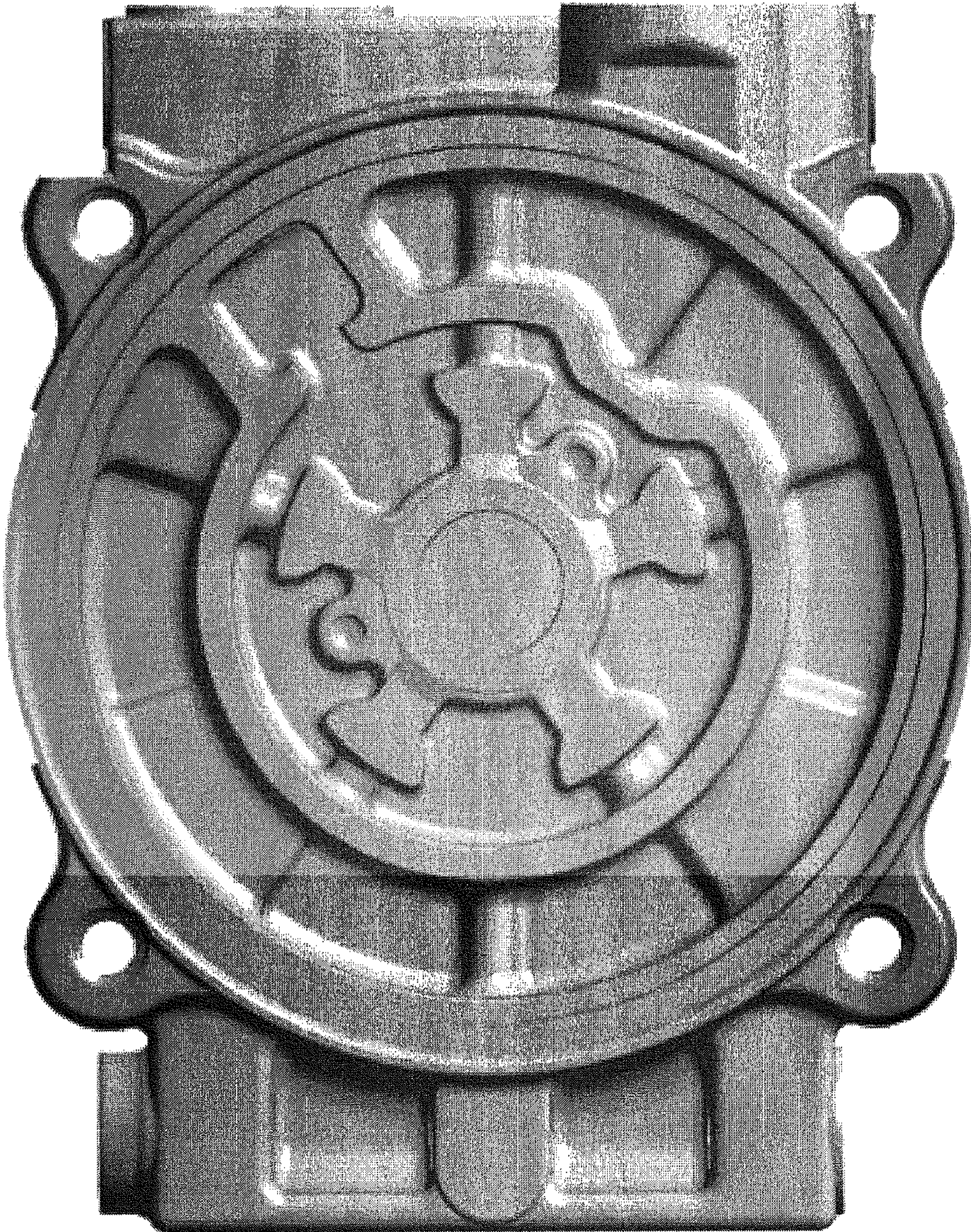

FIG. 4

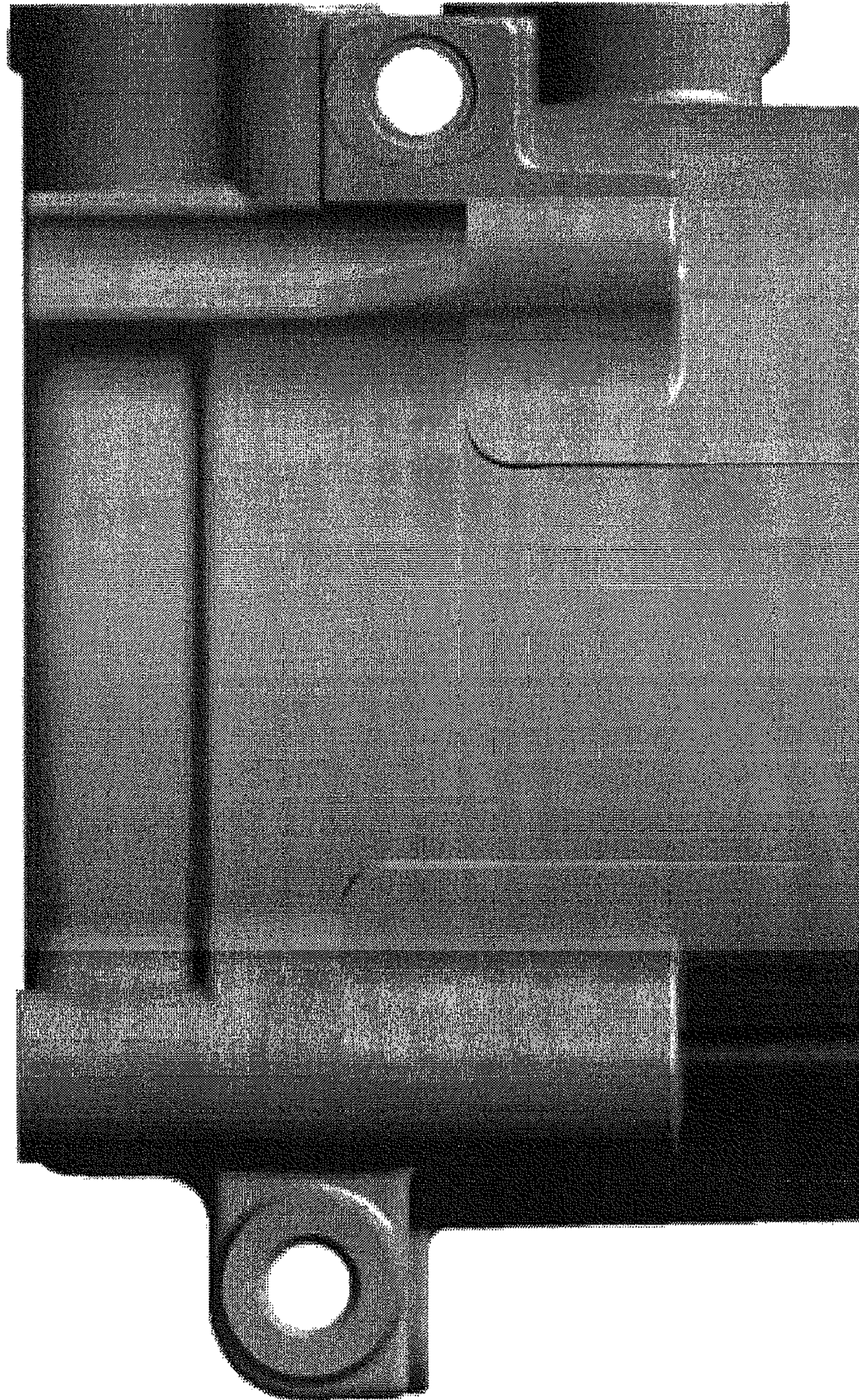

FIG. 5

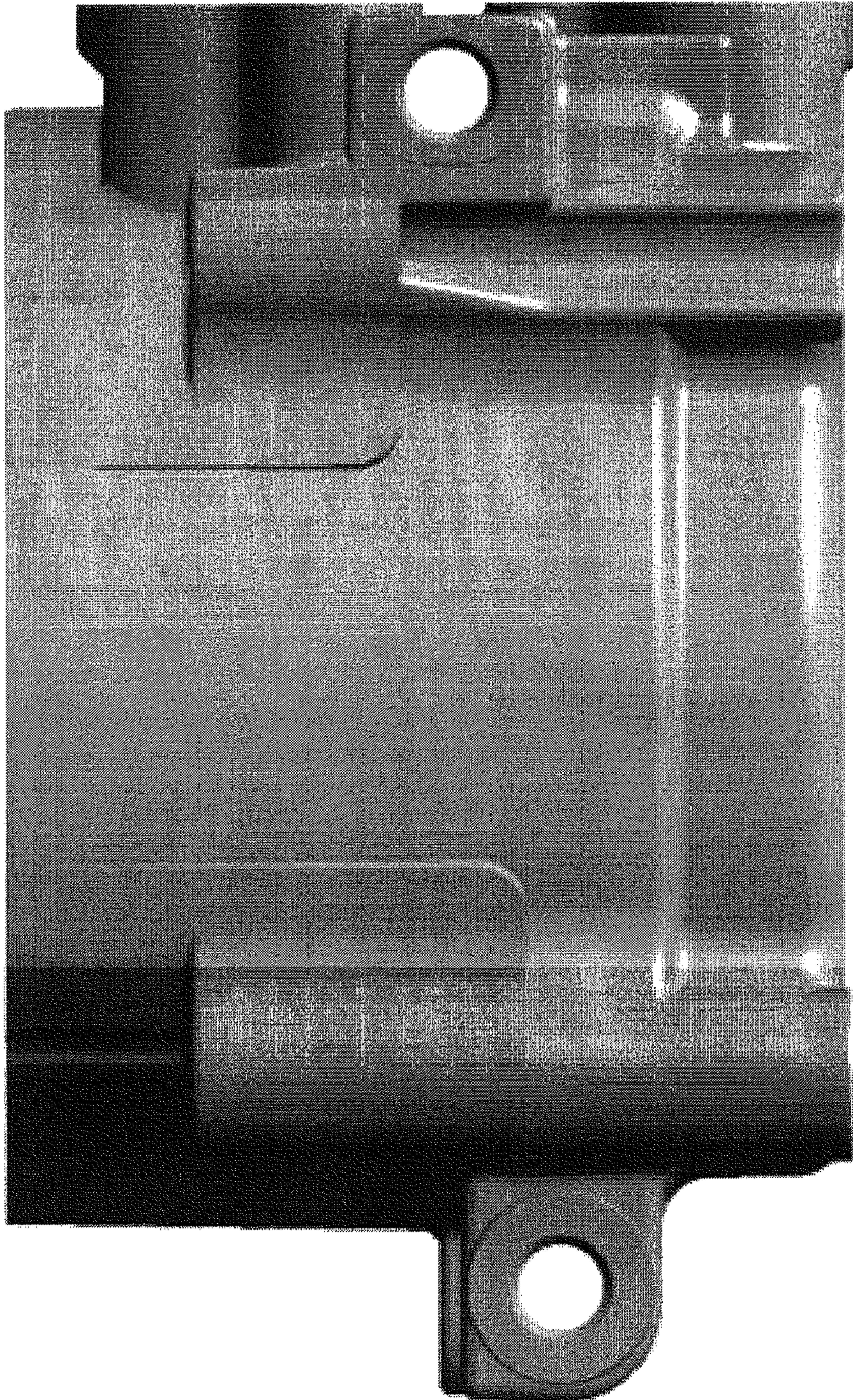

FIG. 6

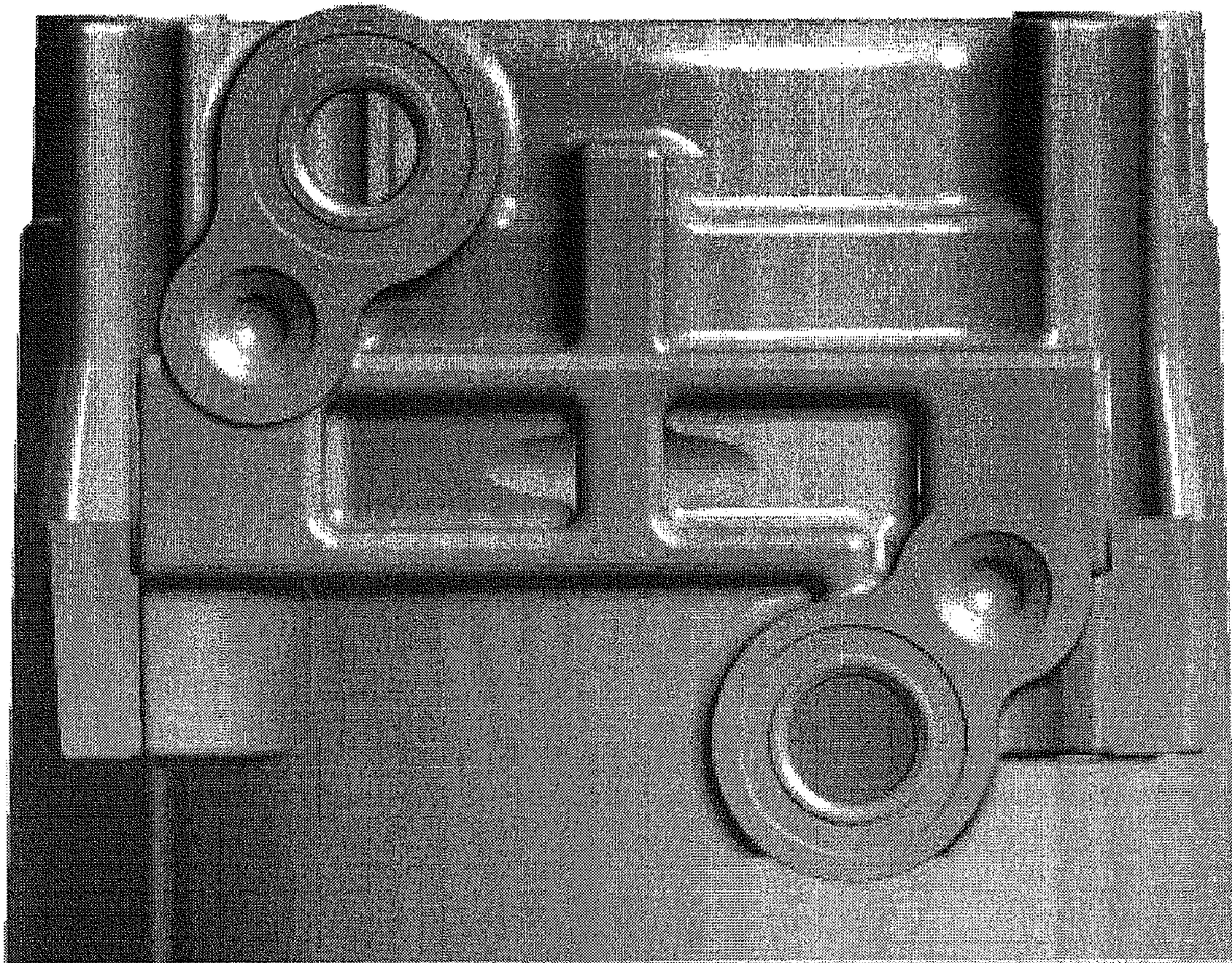

FIG. 7

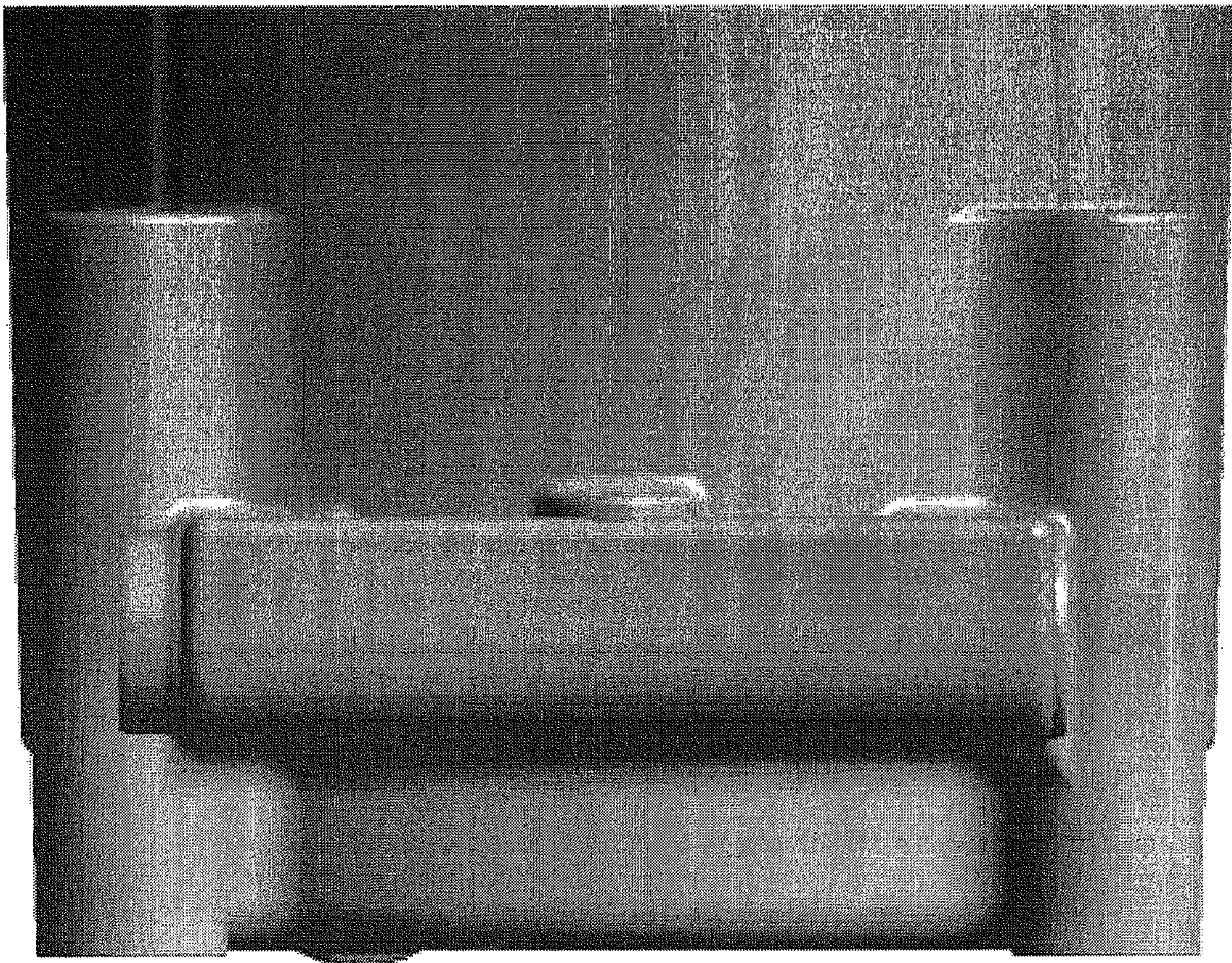

FIG. 8

