

US00D625283S

(12) **United States Design Patent**
Okada et al.

(10) **Patent No.:** **US D625,283 S**

(45) **Date of Patent:** **** Oct. 12, 2010**

(54) **MOBILE PHONE**

(75) Inventors: **Norio Okada**, Tokyo (JP); **Jong-Seong Lee**, Seoul (KR); **Yusuru Masuda**, Tokyo (JP)

(73) Assignee: **Samsung Electronics Co., Ltd.**, Suwon-Si (KR)

(**) Term: **14 Years**

(21) Appl. No.: **29/343,602**

(22) Filed: **Sep. 16, 2009**

(30) **Foreign Application Priority Data**

Jul. 22, 2009 (KR) 30-2009-0032393

(51) **LOC (9) Cl.** **14-03**

(52) **U.S. Cl.** **D14/138 AB**

(58) **Field of Classification Search** D14/138 AB,
D14/496, 341, 345, 346, 203.3, 203.4, 203.7;
455/575.3; D21/517; 379/433.13

See application file for complete search history.

(56) **References Cited**

U.S. PATENT DOCUMENTS

D143,682	S	*	1/1946	Thomsen	D28/78
D144,987	S	*	6/1946	Reilly	D28/82
D401,017	S	*	11/1998	Thorpe	D28/78
D462,809	S	*	9/2002	LaSpina et al.	D28/78
D525,230	S	*	7/2006	Kim et al.	D14/138 AB
D540,292	S	*	4/2007	Lee et al.	D14/138 AB
D562,295	S	*	2/2008	Lindner et al.	D14/138 AB
D579,153	S	*	10/2008	Lee	D28/83
D580,900	S	*	11/2008	Wong et al.	D14/138 AA
D584,268	S	*	1/2009	Kim	D14/138 AB
D585,409	S	*	1/2009	Kim	D14/138 AB
D588,564	S	*	3/2009	Pegon et al.	D14/138 AA
D589,486	S	*	3/2009	He	D14/138 AB
D590,807	S	*	4/2009	Kim et al.	D14/138 AB

D596,609	S	*	7/2009	Kim et al.	D14/138 AB
D597,052	S	*	7/2009	Kim et al.	D14/138 AB
D602,894	S	*	10/2009	Lepoutier et al.	...	D14/138 AB
D606,532	S	*	12/2009	de Jong et al.	D14/250
D606,986	S	*	12/2009	de Jong et al.	D14/250

(Continued)

OTHER PUBLICATIONS

BenQ A520 telephone, announced 1st quarter 2005, [online], [site visited Jun. 18, 2010]. Available from Internet, <URL: <http://www.gsmarena.com>>.*

(Continued)

Primary Examiner—Jeffrey D Asch
(74) *Attorney, Agent, or Firm*—Staas & Halsey LLP

(57) **CLAIM**

The ornamental design for a mobile phone, as shown and described.

DESCRIPTION

FIG. 1 is a front perspective view of a mobile phone;
FIG. 2 is a front view of the mobile phone of FIG. 1;
FIG. 3 is a rear view of the mobile phone of FIG. 1;
FIG. 4 is a left-side view of the mobile phone of FIG. 1;
FIG. 5 is a right-side view of the mobile phone of FIG. 1;
FIG. 6 is a top plan view of the mobile phone of FIG. 1;
FIG. 7 is a bottom plan view of the mobile phone of FIG. 1;
and,
FIG. 8 is a front perspective open view of the mobile phone of FIG. 1.

1 Claim, 5 Drawing Sheets

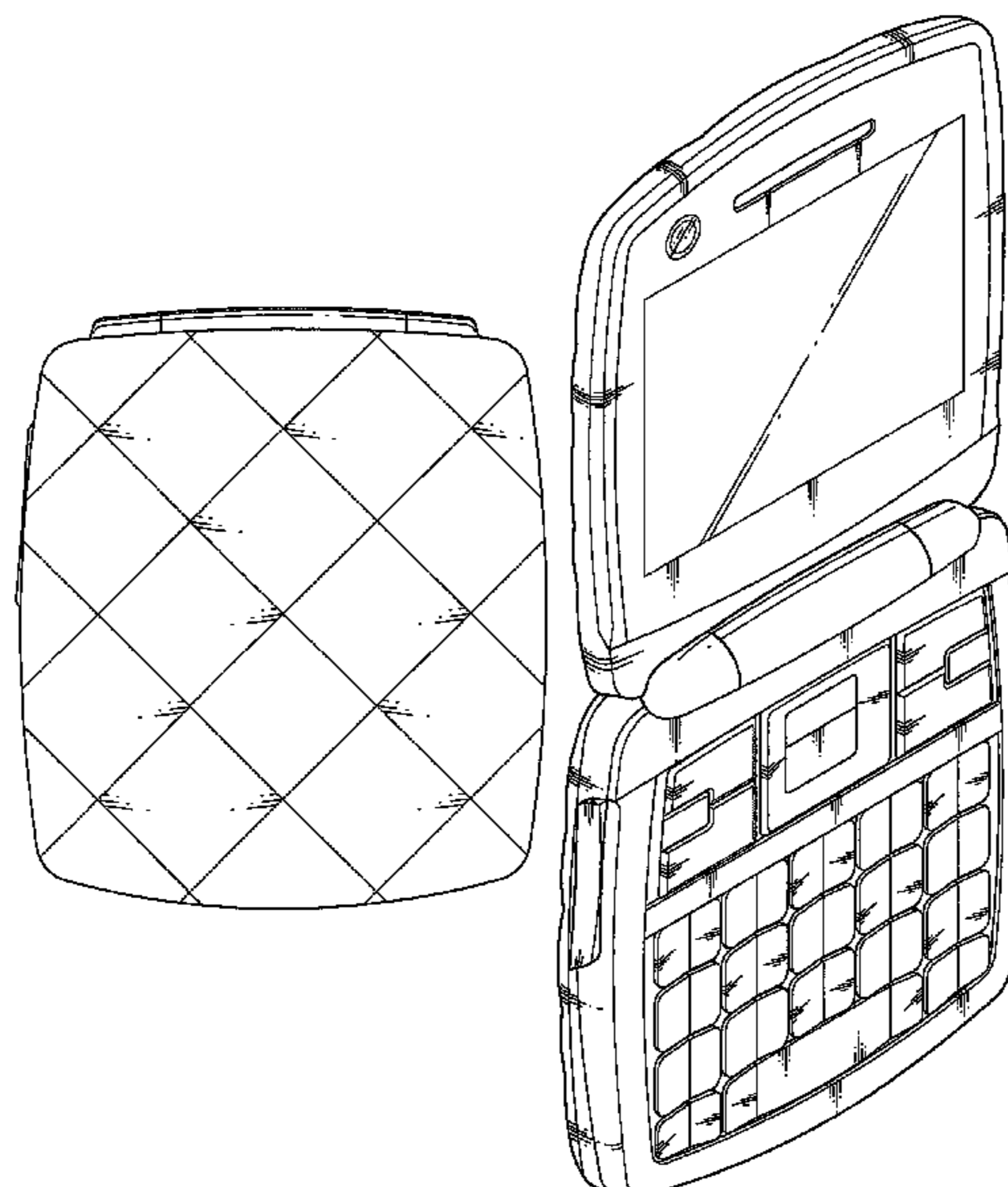

U.S. PATENT DOCUMENTS

D607,430 S * 1/2010 Song et al. D14/138 AB
D608,752 S * 1/2010 He D14/138 AA
D612,353 S * 3/2010 Kim D14/138 AB
D612,827 S * 3/2010 Song et al. D14/138 AB
D613,718 S * 4/2010 Lee et al. D14/138 AB
D615,940 S * 5/2010 Kim et al. D14/138 AA
2003/0003956 A1* 1/2003 Maenpaa et al. 455/556

OTHER PUBLICATIONS

Samsung S5150 Diva folder telephone, announced Dec. 2009, [online], [site visited Jun. 18, 2010]. Available from Internet ,<URL: <http://www.gsmarena.com>>.*

Nokia 7070 Prism telephone, announced Apr. 2008, [online], [site visited Jun. 18, 2010]. Available from Internet ,<URL: <http://www.gsmarena.com>>.*

Sony Ericsson Z555 telephone, announced Jan. 2008, [online], [site visited Jun. 18, 2010]. Available from Internet ,<URL: <http://www.gsmarena.com>>.*

NEC N910 telephone, announced 1st quarter 2004, [online], [site visited Jun. 18, 2010]. Available from Internet ,<URL: <http://www.gsmarena.com>>.*

Telit t410 telephone, announced 1st quarter 2005, [online], [site visited Jun. 18, 2010]. Available from Internet ,<URL: <http://www.gsmarena.com>>.*

* cited by examiner

FIG. 1

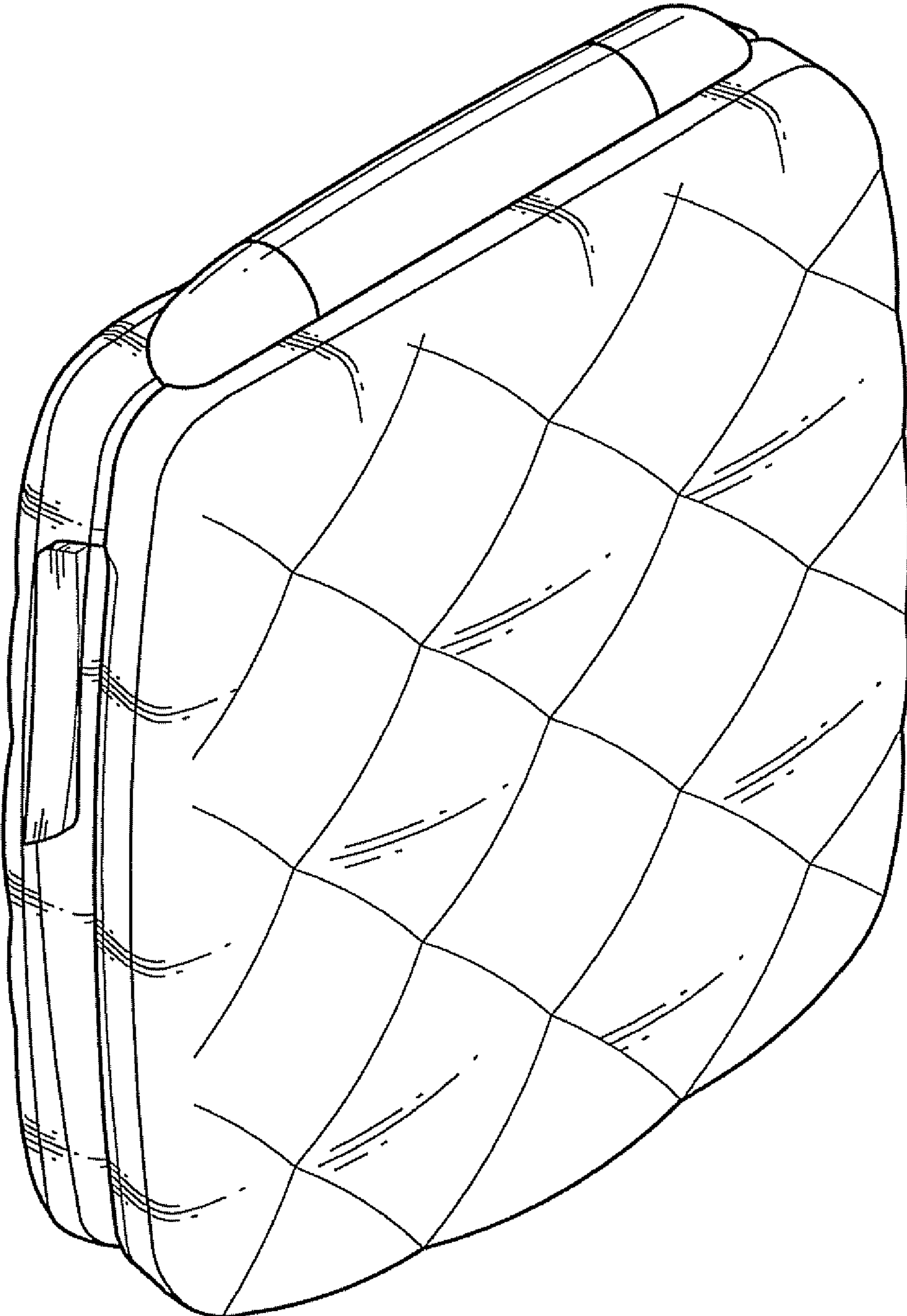

FIG. 2

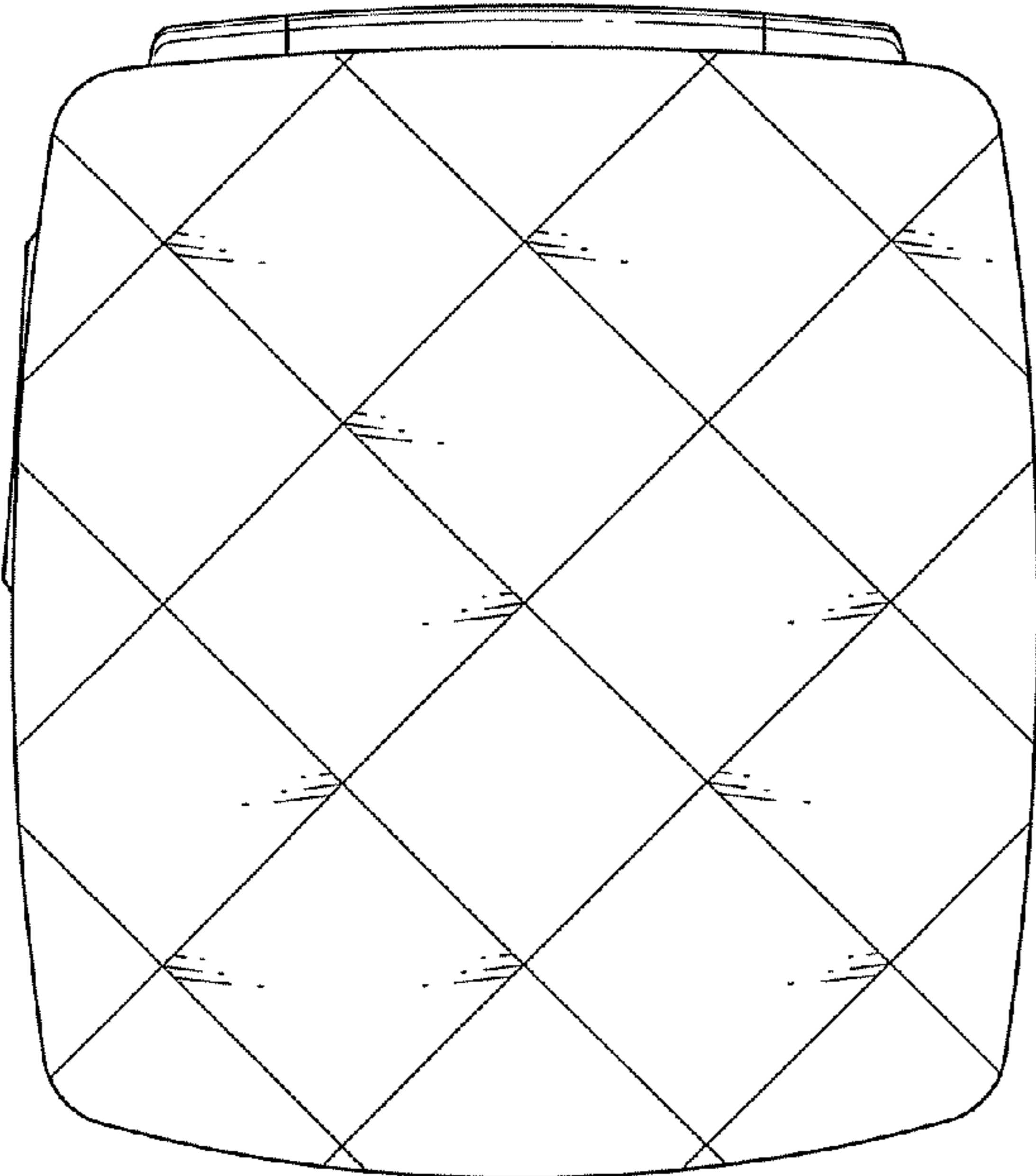

FIG. 3

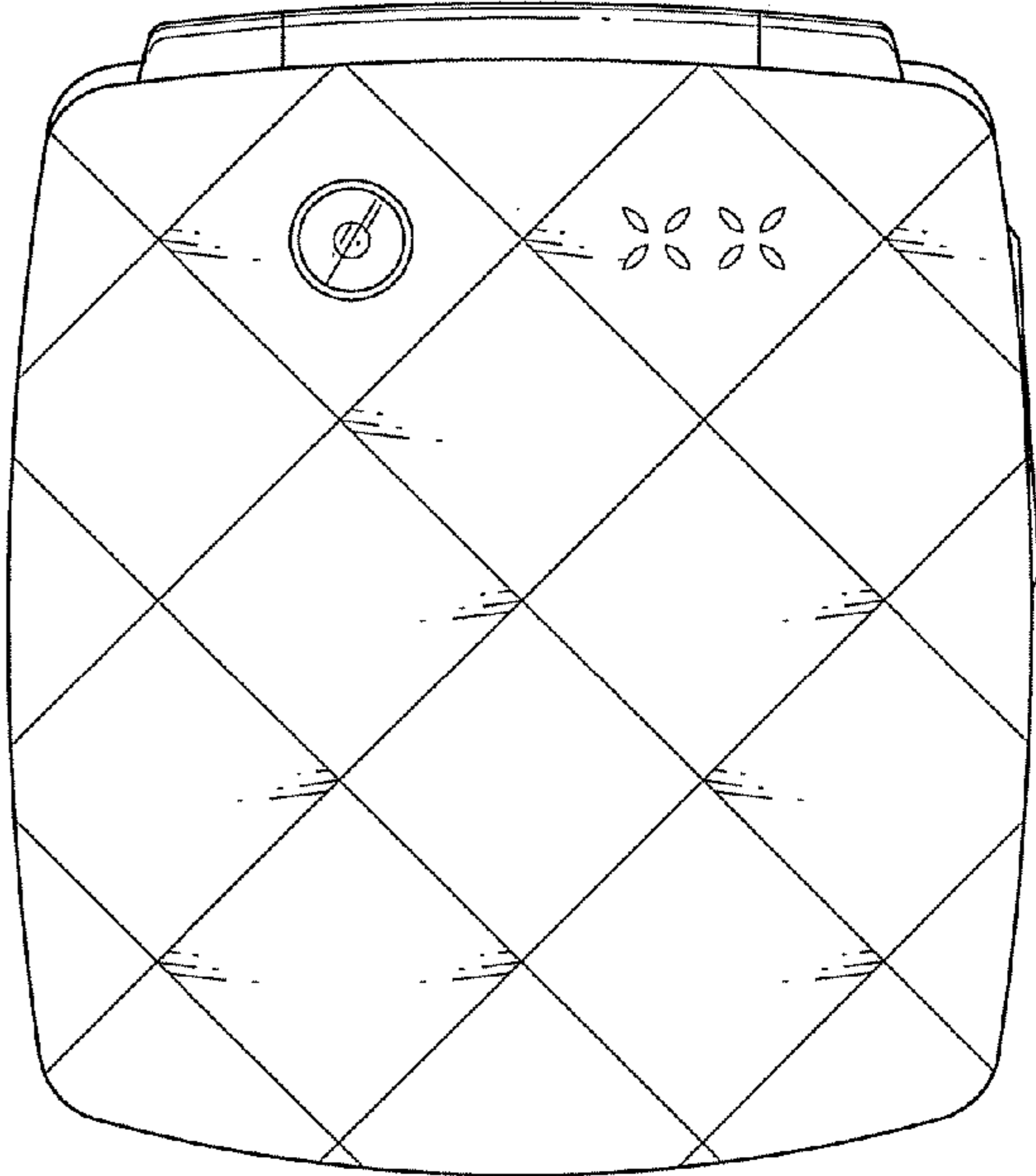

FIG. 4

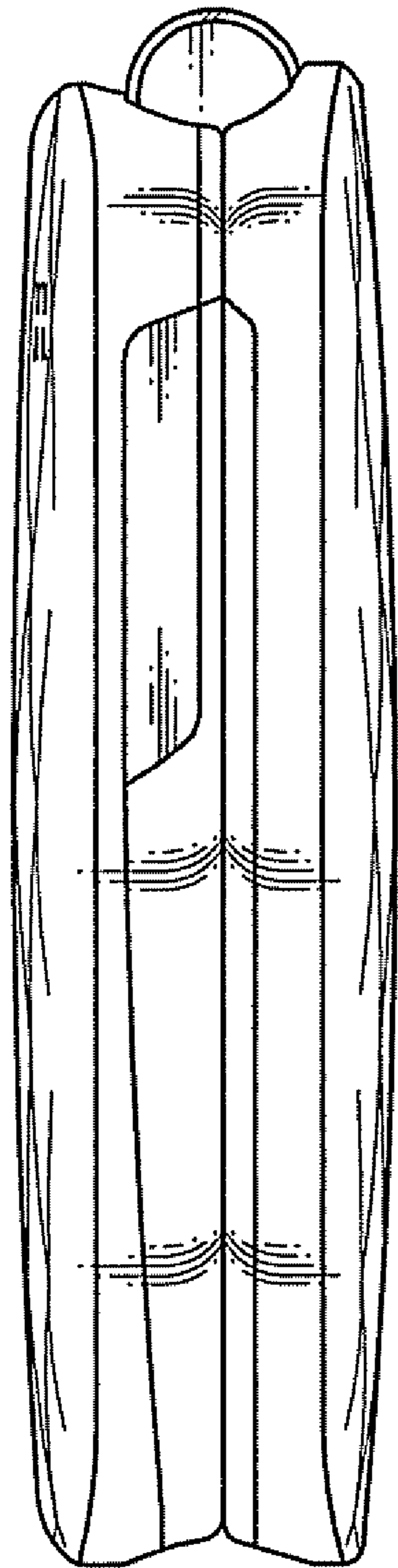

FIG. 5

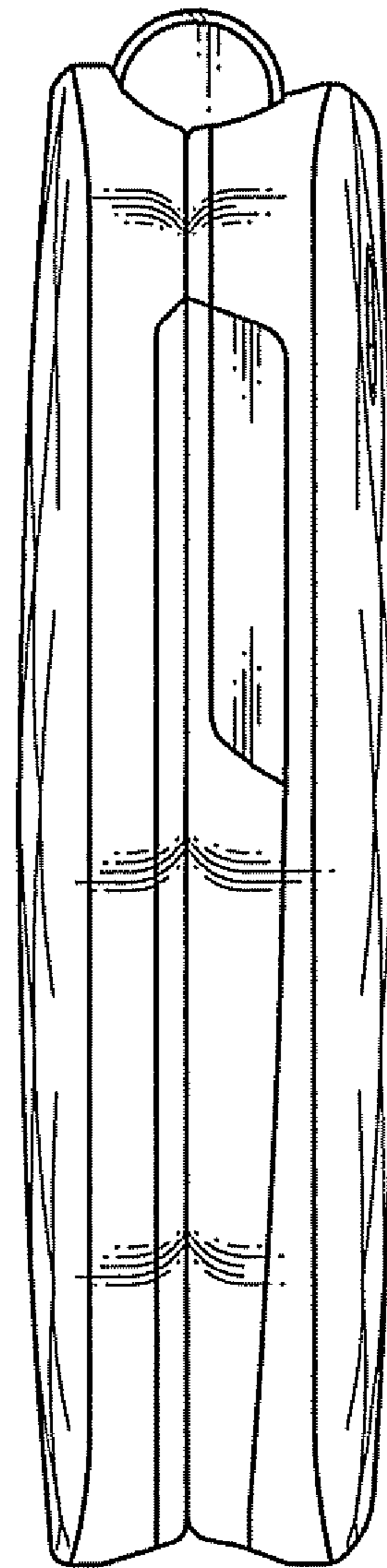

FIG. 6

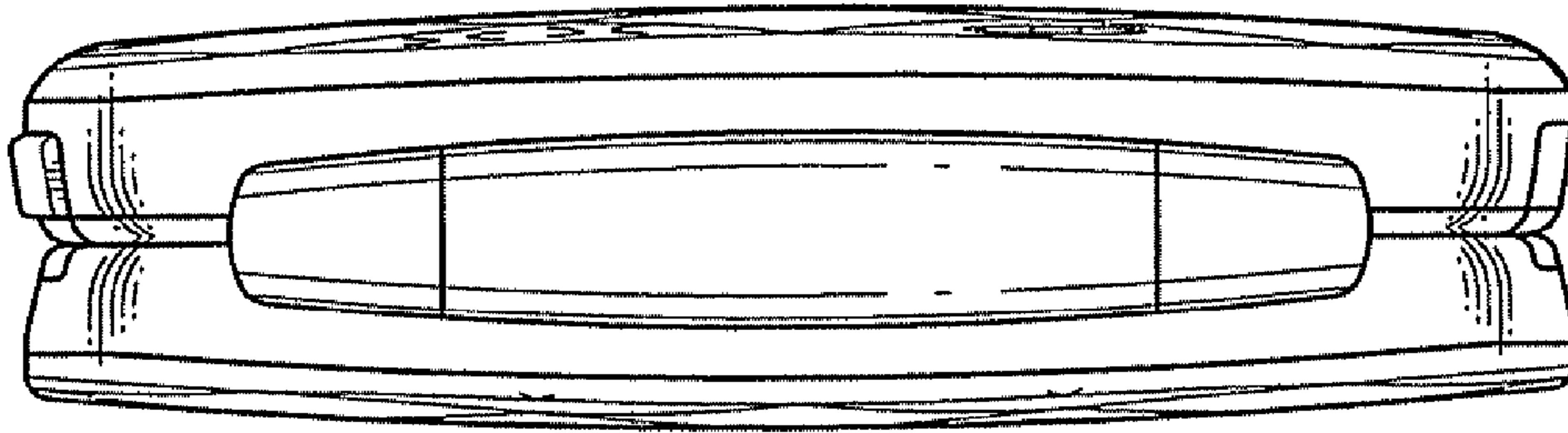

FIG. 7

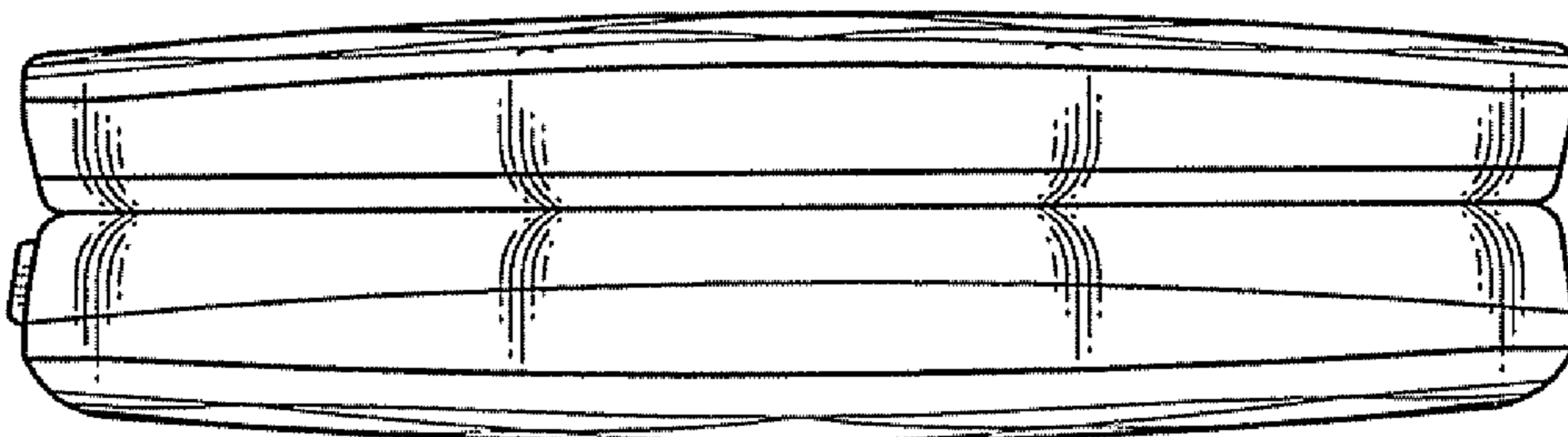

FIG. 8

