



US00D625282S

(12) **United States Design Patent**
Lee et al.

(10) **Patent No.:** **US D625,282 S**
(45) **Date of Patent:** **** Oct. 12, 2010**

(54) **MOBILE PHONE**

(75) Inventors: **Jin-Hoo Lee**, Seoul (KR); **Young-Keun Lee**, Seoul (KR); **Chang-Hwan Hwang**, Goyang-si (KR)

(73) Assignee: **Samsung Electronics Co., Ltd.**, Suwon-Si (KR)

(**) Term: **14 Years**

(21) Appl. No.: **29/343,016**

(22) Filed: **Sep. 4, 2009**

(30) **Foreign Application Priority Data**

Jun. 4, 2009 (KR) 30-2009-0024737

(51) **LOC (9) Cl.** **14-03**

(52) **U.S. Cl.** **D14/138 AB**

(58) **Field of Classification Search** D14/138 AB,
D14/138 R, 138 AD, 138 G, 341-347, 203.4,
D14/203.7, 203.2, 191; 455/575.3, 575.1,
455/556.2; 379/433.11, 433.13; D21/517;
D18/7

See application file for complete search history.

(56) **References Cited**

U.S. PATENT DOCUMENTS

- D269,353 S * 6/1983 Yokoyama D18/2
- D304,930 S * 12/1989 Hongo et al. D14/334
- D329,427 S * 9/1992 St. Peter et al. D14/346
- D356,594 S * 3/1995 Nakashima et al. D18/5
- D365,839 S * 1/1996 Kurabuti et al. D14/345
- D377,042 S * 12/1996 Komatsu et al. D14/345
- D416,256 S * 11/1999 Griffin et al. D14/191
- D430,554 S * 9/2000 Nguyen et al. D14/191

- D465,218 S * 11/2002 Schebesch et al. D14/343
- D469,749 S * 2/2003 Kim D14/138 AA
- 6,847,519 B2 * 1/2005 Arbisi et al. 361/679.12
- D531,156 S * 10/2006 Ahn et al. D14/138 C
- 7,203,533 B1 * 4/2007 Tischer 455/575.8
- D544,458 S * 6/2007 Huang D14/138 AA
- D548,212 S * 8/2007 Lee D14/138 AB

(Continued)

OTHER PUBLICATIONS

LG KE600 telephone, announced Mar. 2006, [online], [site visited May 22, 2010]. Available from Internet ,<URL: http://www.gsmarena.com>.*

(Continued)

Primary Examiner—Jeffrey D Asch
(74) *Attorney, Agent, or Firm*—Staas & Halsey LLP

(57) **CLAIM**

The ornamental design for a mobile phone, as shown and described.

DESCRIPTION

FIG. 1 is a front perspective view of a mobile phone;
FIG. 2 is a front view of the mobile phone of FIG. 1;
FIG. 3 is a rear view of the mobile phone of FIG. 1;
FIG. 4 is a left-side view of the mobile phone of FIG. 1;
FIG. 5 is a right-side view of the mobile phone of FIG. 1;
FIG. 6 is a top plan view of the mobile phone of FIG. 1;
FIG. 7 is a bottom plan view of the mobile phone of FIG. 1;
and,
FIG. 8 is a front perspective open view of the mobile phone of FIG. 1.

1 Claim, 5 Drawing Sheets

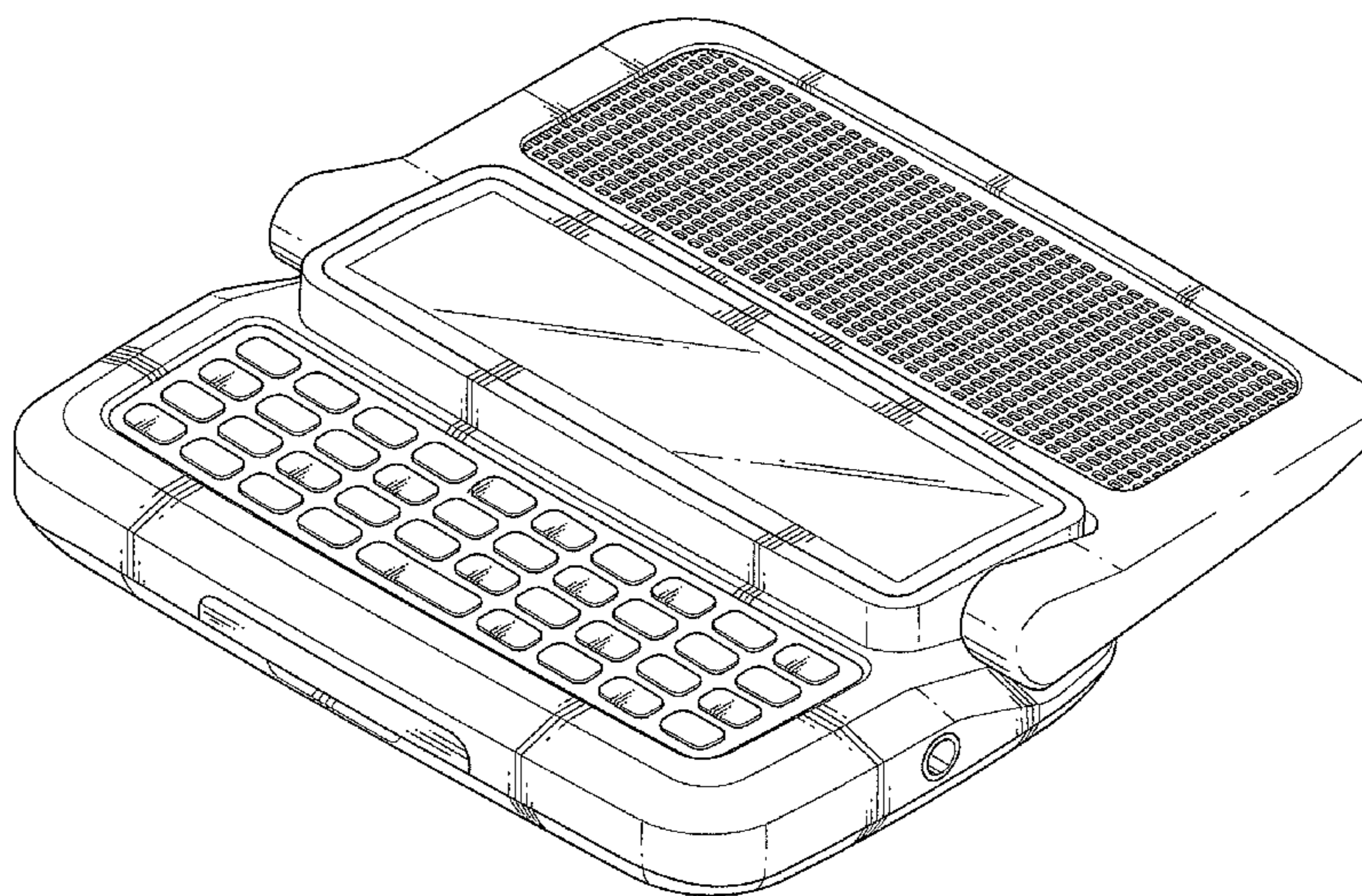
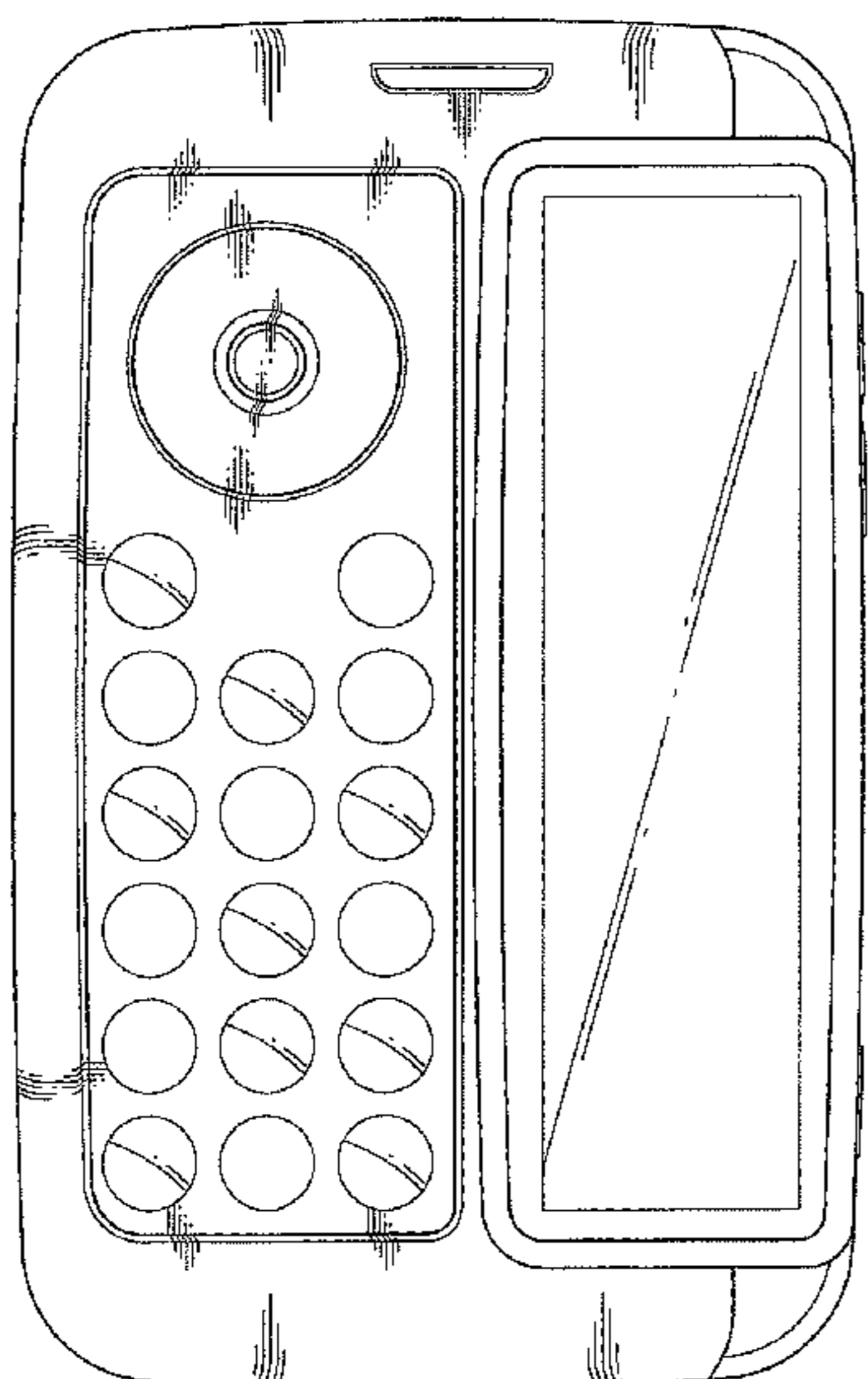

US D625,282 S

Page 2

U.S. PATENT DOCUMENTS

D552,070 S * 10/2007 Park D14/138 AB
D557,674 S * 12/2007 Lee et al. D14/138 AB
D558,720 S * 1/2008 Lee et al. D14/138 AD
D563,364 S * 3/2008 Kim et al. D14/138 AB
D568,279 S * 5/2008 Kwon et al. D14/138 AB
D572,221 S * 7/2008 Yang et al. D14/138 AB
D580,928 S * 11/2008 Bemelmans et al. D14/345
D585,406 S * 1/2009 Morrison et al. D14/138 AB
D615,056 S * 5/2010 Kim et al. D14/138 AB
2003/0073456 A1* 4/2003 Griffin et al. 455/550

2008/0070644 A1* 3/2008 Park et al. 455/575.3

OTHER PUBLICATIONS

Alcatel OT-E159 telephone, announced 1st quarter 2005, [online], [site visited May 22, 2010]. Available from Internet ,<URL: <http://www.gsmarena.com>>.*

LG Optimus Q telephone, announced Apr. 2010, [online], [site visited May 22, 2010]. Available from Internet ,<URL: <http://www.gsmarena.com>>.*

Samsung F520 telephone, announced Feb. 2007, [online], [site visited May 22, 2010]. Available from Internet ,<URL: <http://www.gsmarena.com>>.*

* cited by examiner

FIG. 1

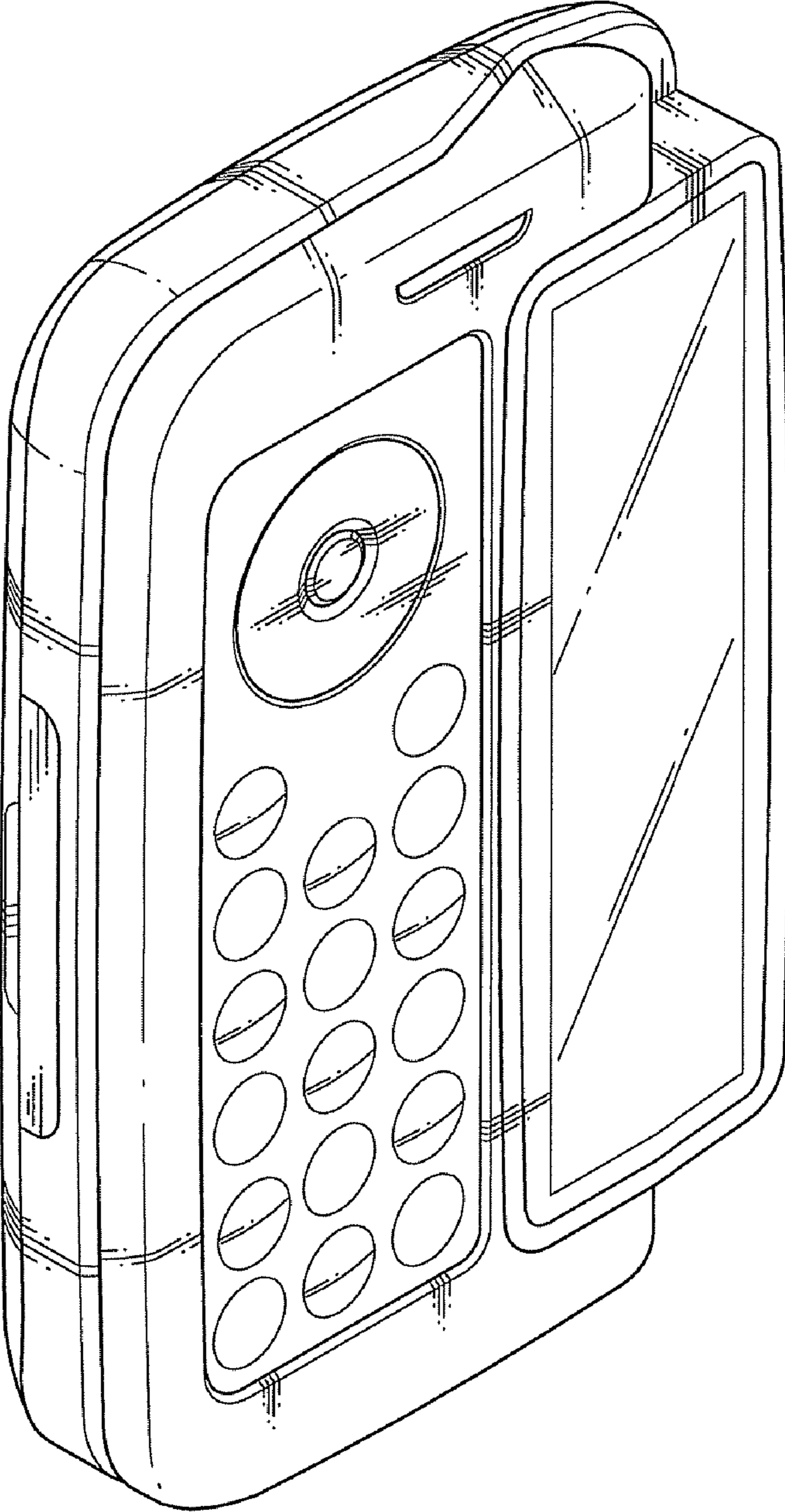

FIG. 2

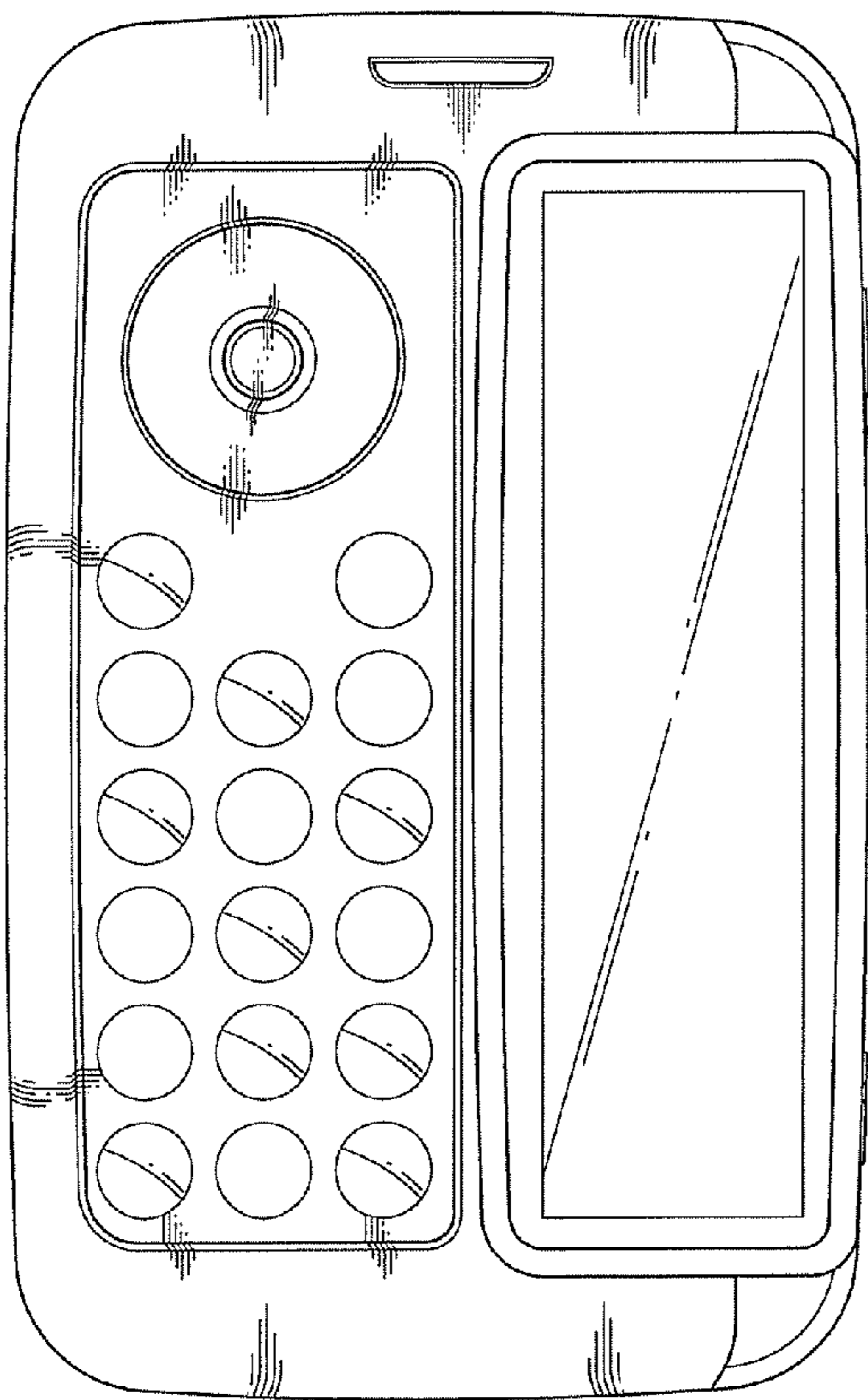

FIG. 3

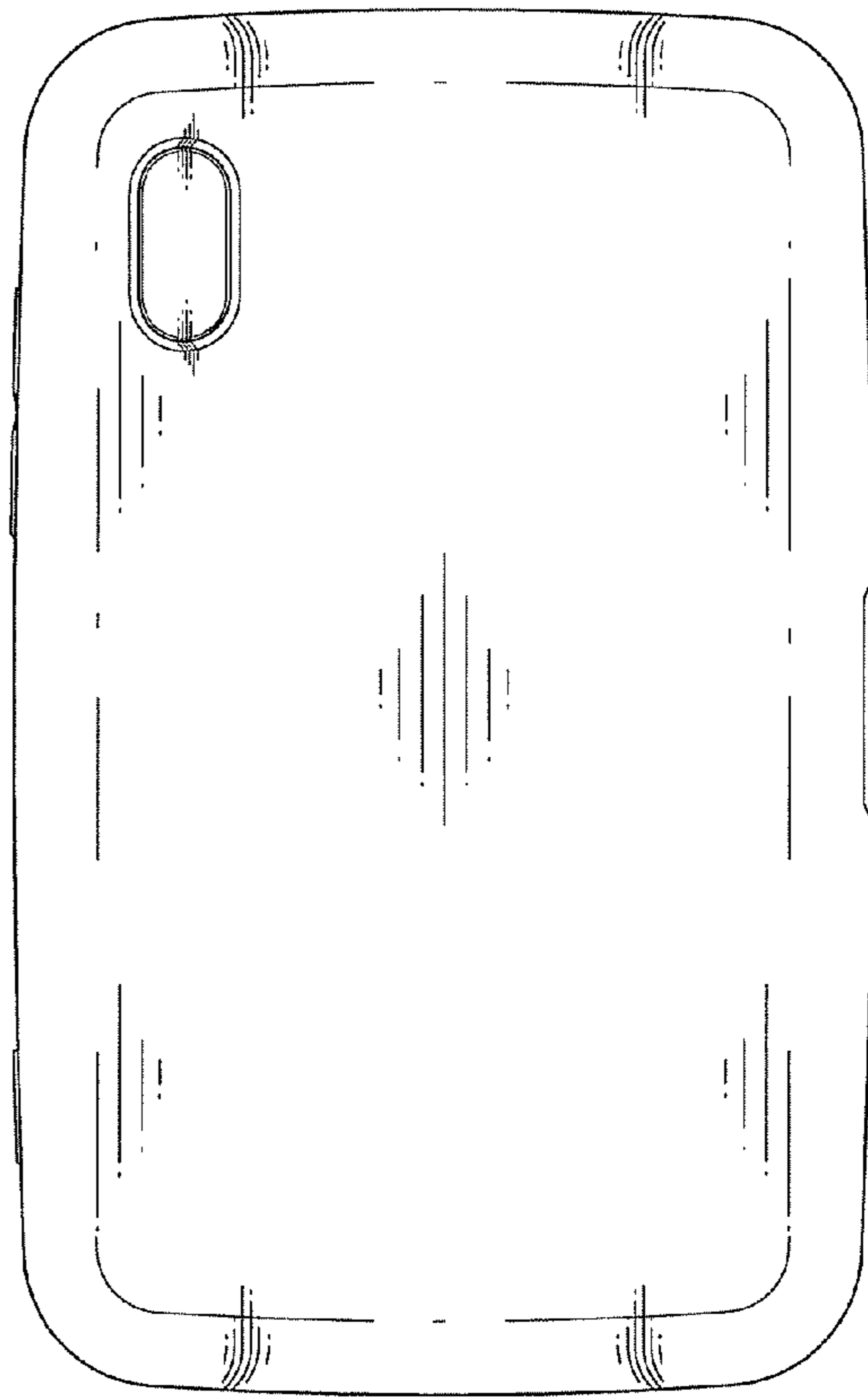

FIG. 4

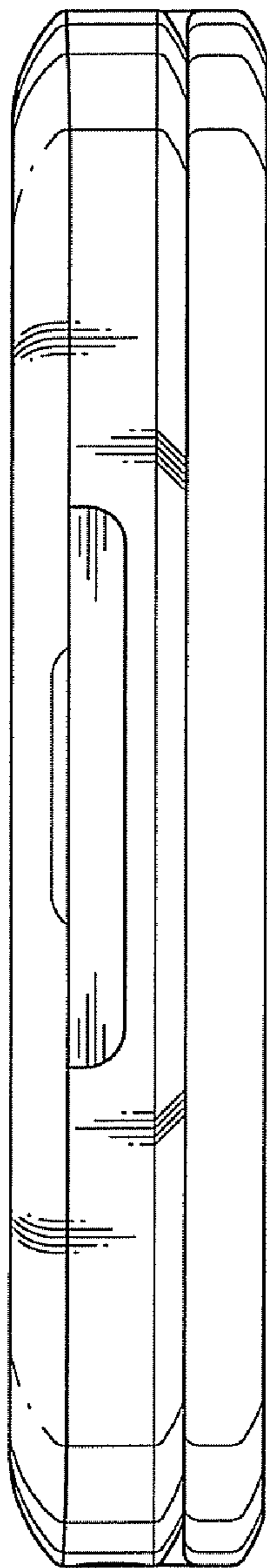

FIG. 5

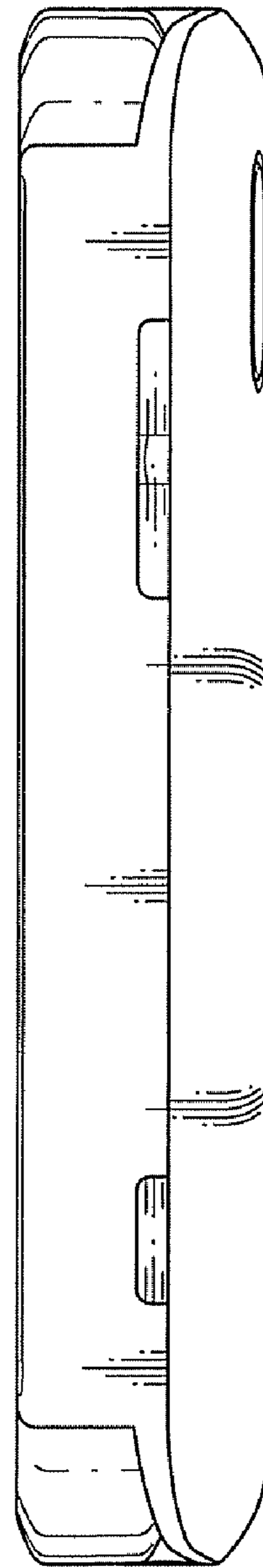

FIG. 6

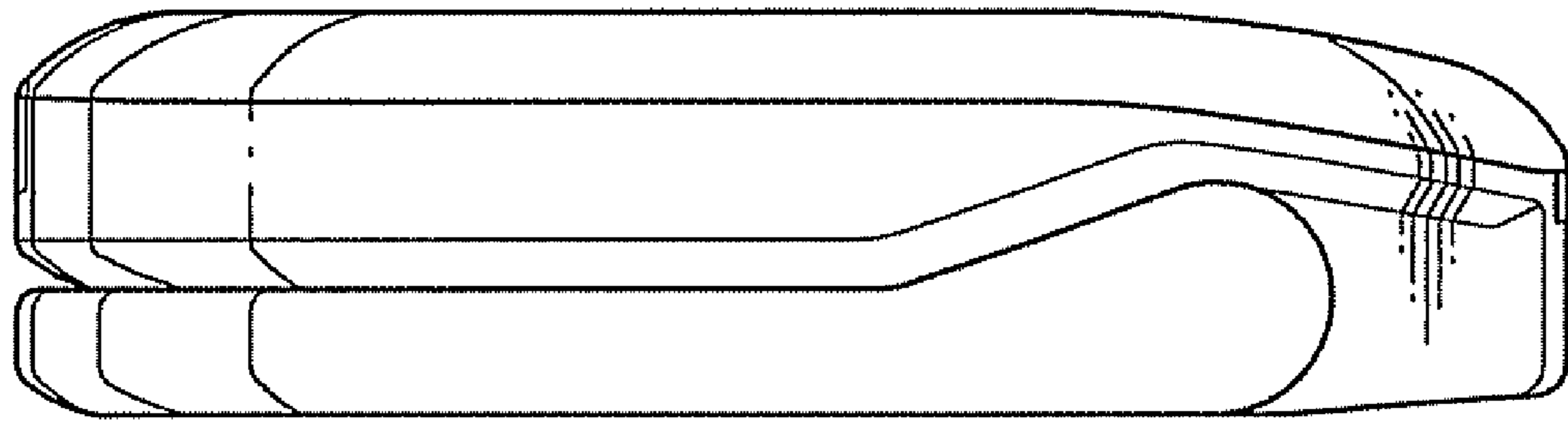

FIG. 7

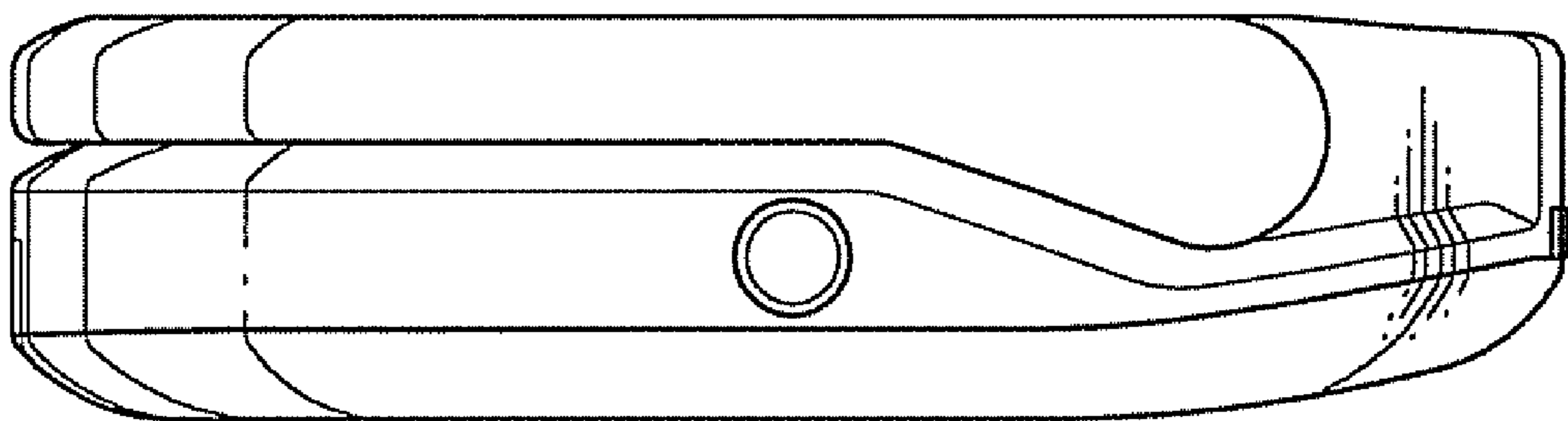

FIG. 8

