



US00D625271S

(12) **United States Design Patent**
Yamanaka

(10) **Patent No.:** **US D625,271 S**
(45) **Date of Patent:** **** Oct. 12, 2010**

(54) **PUSH SWITCH**

(75) Inventor: **Satoshi Yamanaka**, Yao (JP)

(73) Assignee: **Hosiden Corporation**, Osaka (JP)

(**) Term: **14 Years**

(21) Appl. No.: **29/356,622**

(22) Filed: **Mar. 1, 2010**

Related U.S. Application Data

(62) Division of application No. 29/332,520, filed on Feb. 18, 2009, now Pat. No. Des. 613,253.

(30) **Foreign Application Priority Data**

Aug. 19, 2008 (JP) 2008-021141
Aug. 19, 2008 (JP) 2008-021142
Aug. 19, 2008 (JP) 2008-021143

(51) **LOC (9) Cl.** **13-03**

(52) **U.S. Cl.** **D13/158**

(58) **Field of Classification Search** D13/158,
D13/169, 170, 171, 174, 184, 199; 200/1 B,
200/5 A, 6 R, 293, 297, 314, 315, 341, 344,
200/406, 513, 520, 523, 530

See application file for complete search history.

(56) **References Cited**

U.S. PATENT DOCUMENTS

7,022,928 B2 4/2006 Watanabe et al.
D561,705 S 2/2008 Tsuduki

D590,782 S 4/2009 Asada
7,525,059 B2 4/2009 Masuda et al.
7,547,858 B2 6/2009 Nagata
D602,443 S 10/2009 Maehara
D613,253 S * 4/2010 Yamanaka D13/158
D613,254 S * 4/2010 Tsuduki D13/158
2008/0029377 A1 2/2008 Tsuduki
2010/0089733 A1* 4/2010 Yanai et al. 200/341

* cited by examiner

Primary Examiner—Daniel D Bui

Assistant Examiner—Thomas J Johannes

(74) *Attorney, Agent, or Firm*—Rankin, Hill & Clark LLP

(57) **CLAIM**

I claim the ornamental design for a push switch, as shown and described.

DESCRIPTION

FIG. 1 is a front, left side and top perspective view of a push switch showing my new design;

FIG. 2 is a front, right side and bottom perspective view thereof;

FIG. 3 is a rear, right side and top perspective view thereof;

FIG. 4 is a front elevation thereof;

FIG. 5 is a rear view thereof;

FIG. 6 is a left side view thereof; the right side view being a mirror image thereto;

FIG. 7 is a top plan view thereof; and,

FIG. 8 is a bottom plan view thereof.

1 Claim, 4 Drawing Sheets

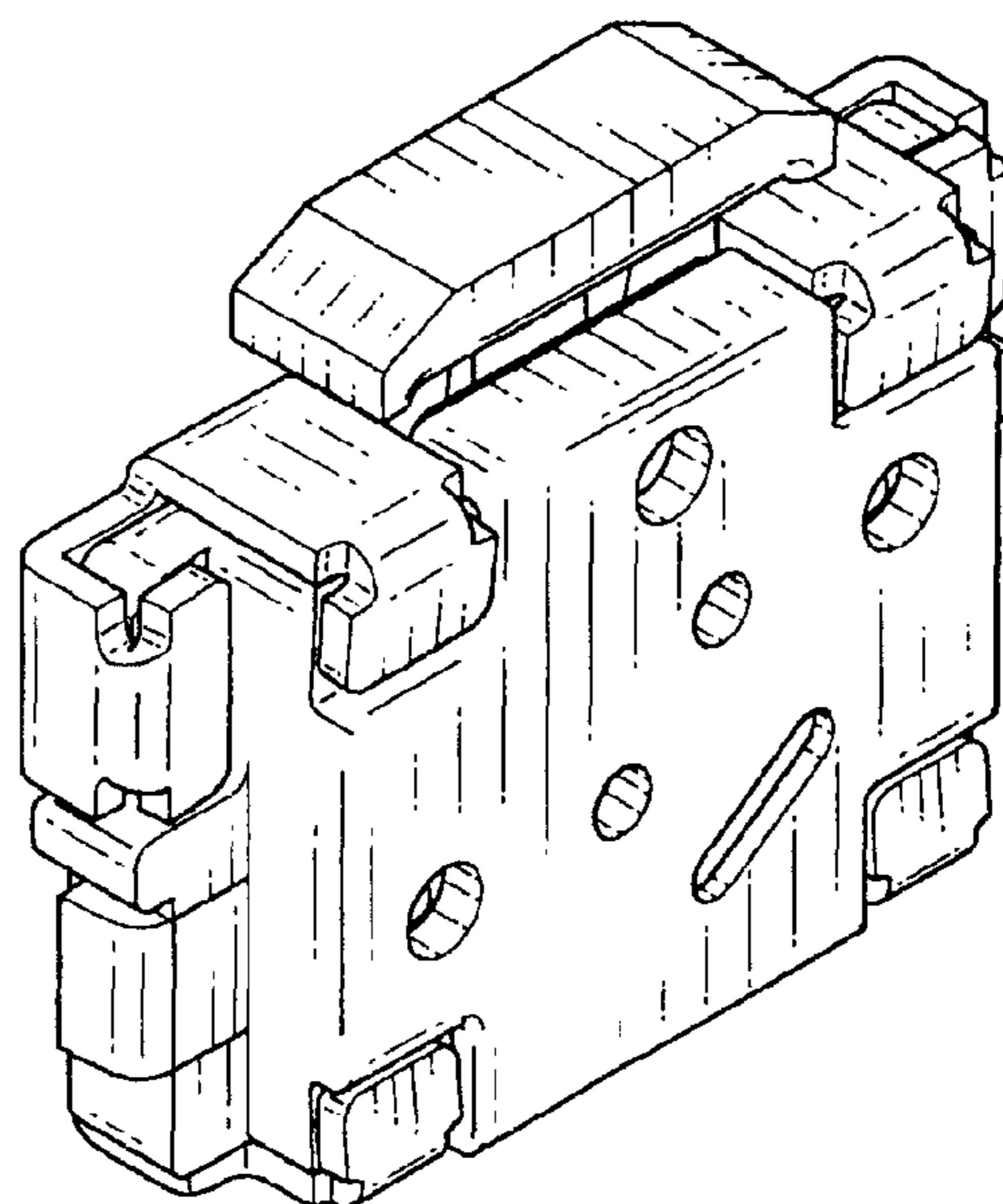
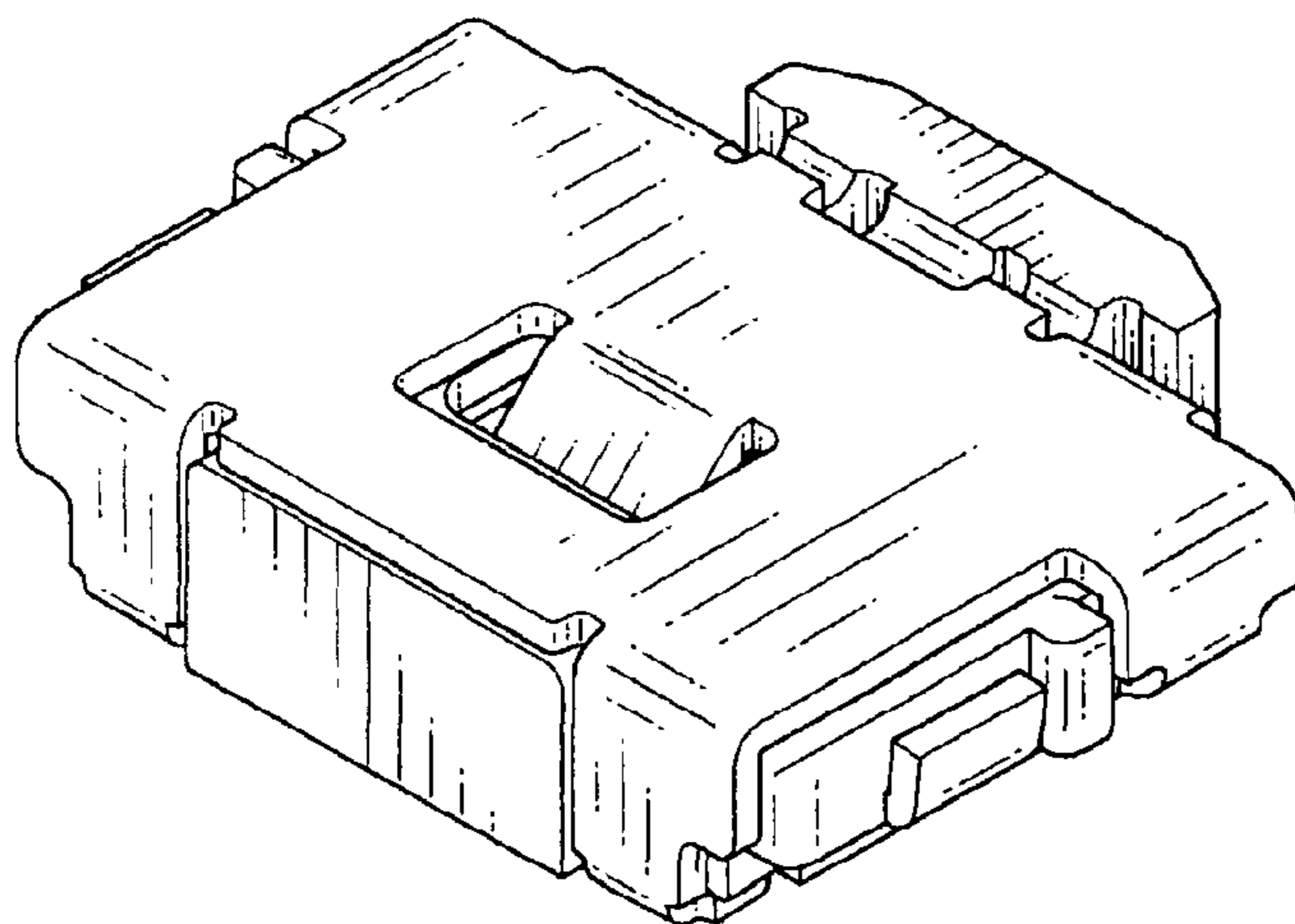

Fig. 1

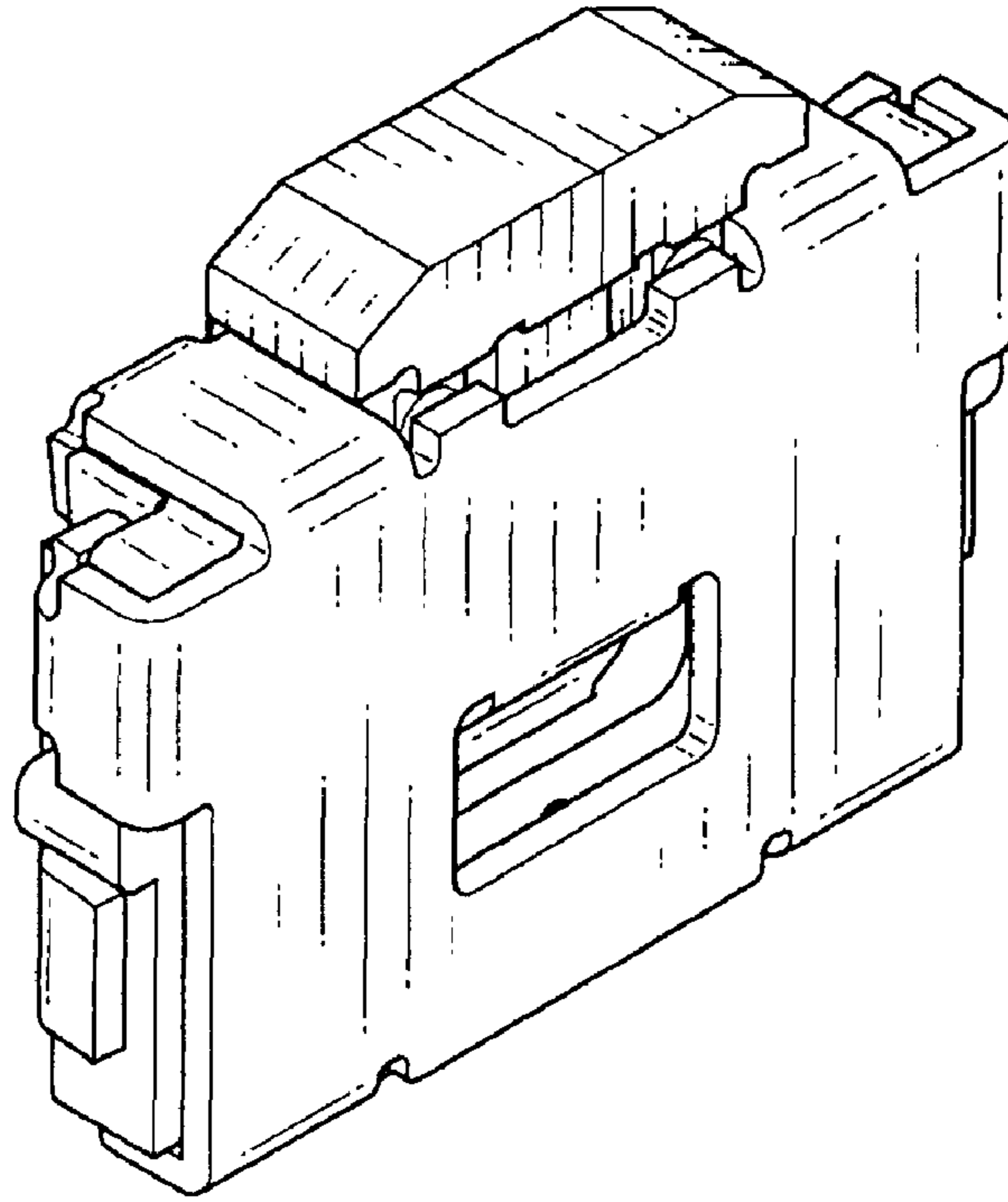

Fig. 2

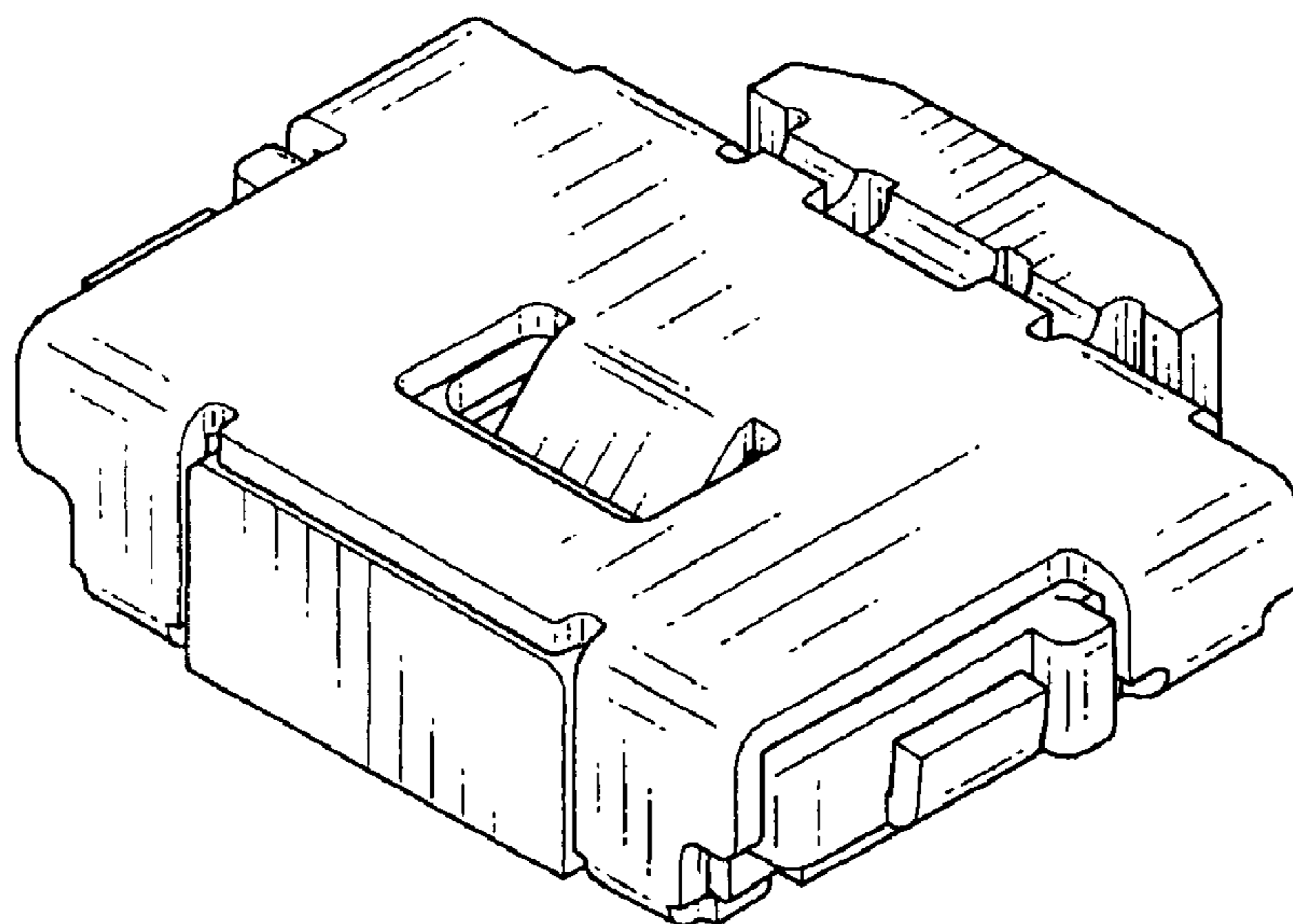

Fig. 3

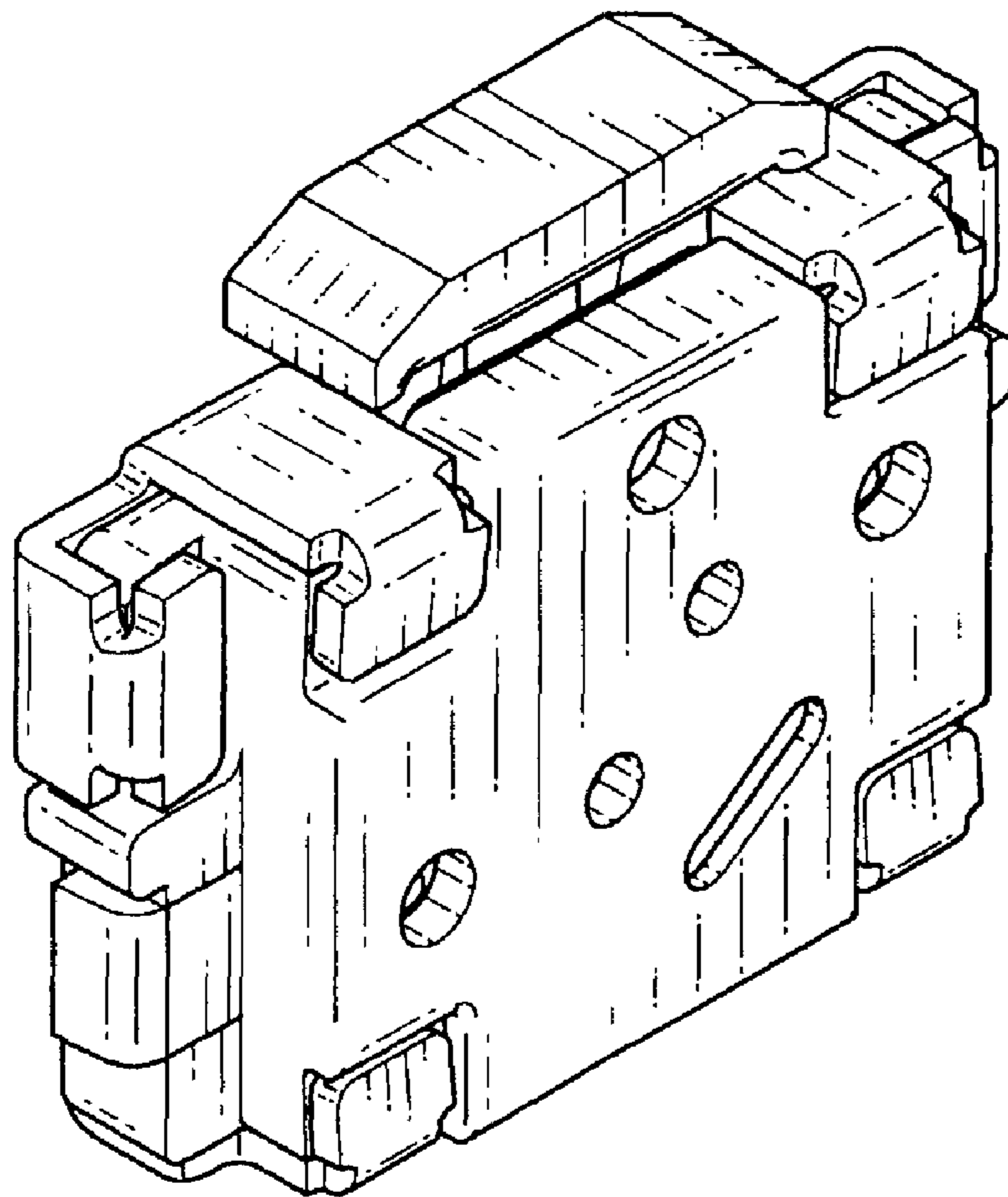

Fig. 4

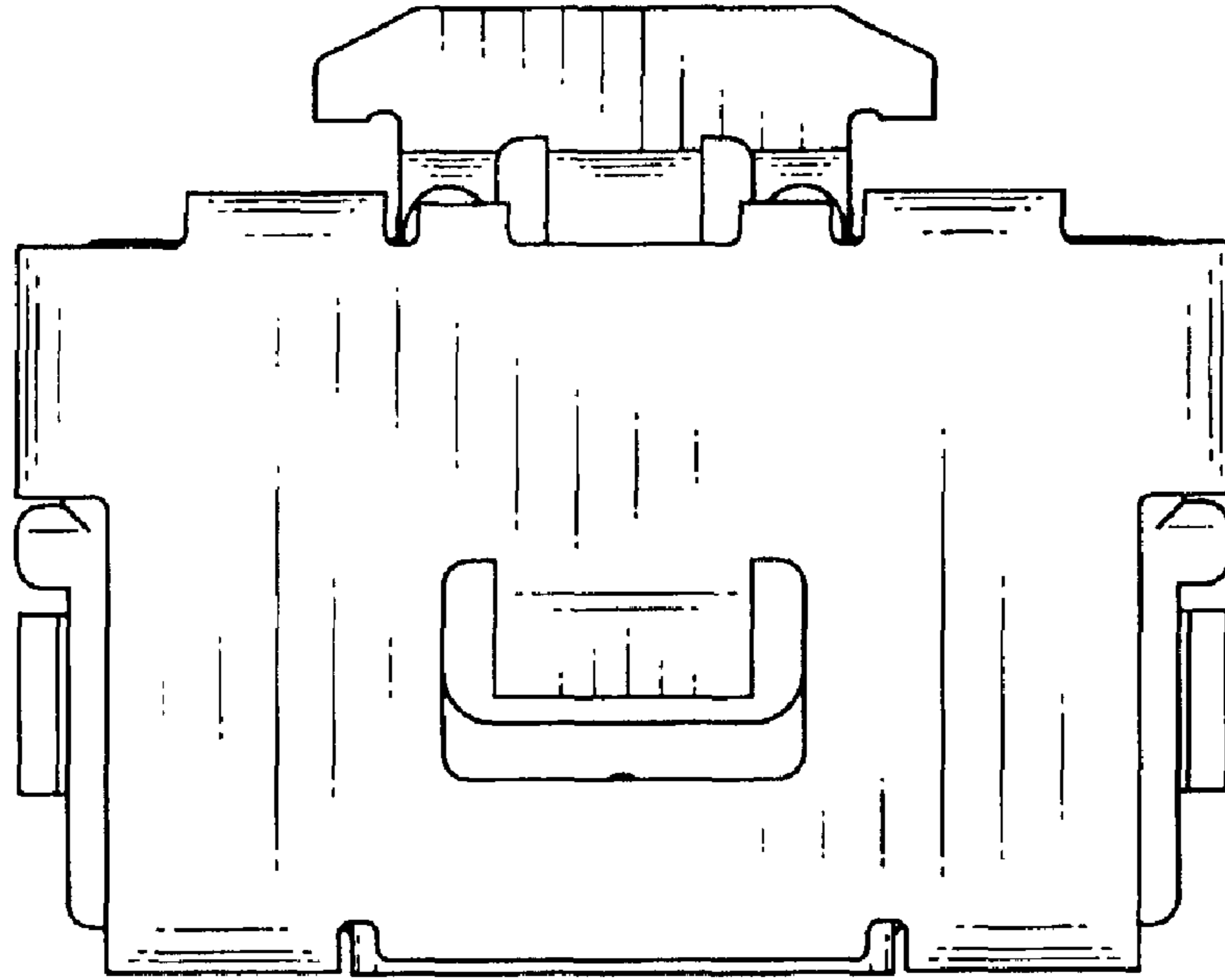

Fig. 5

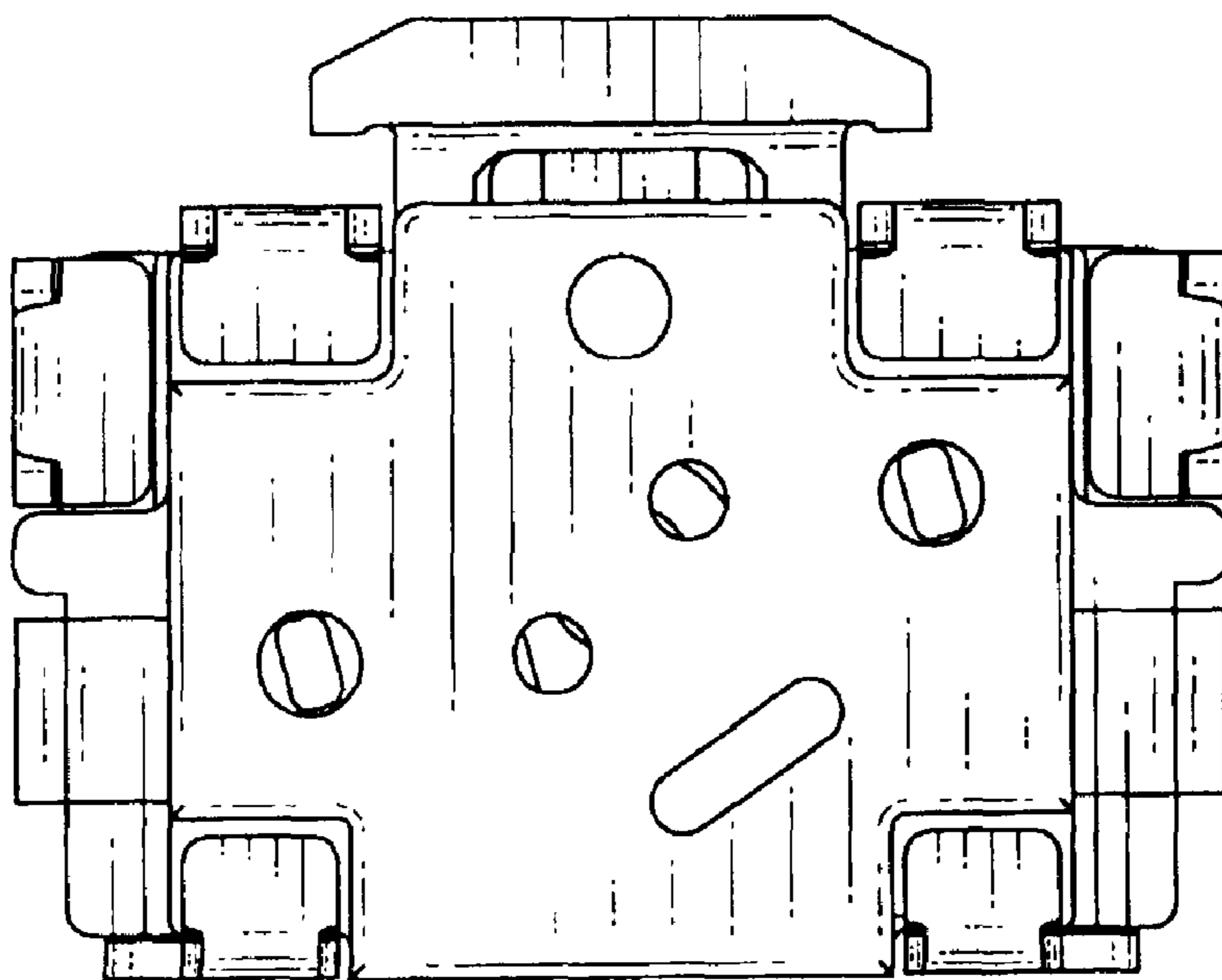

Fig. 6

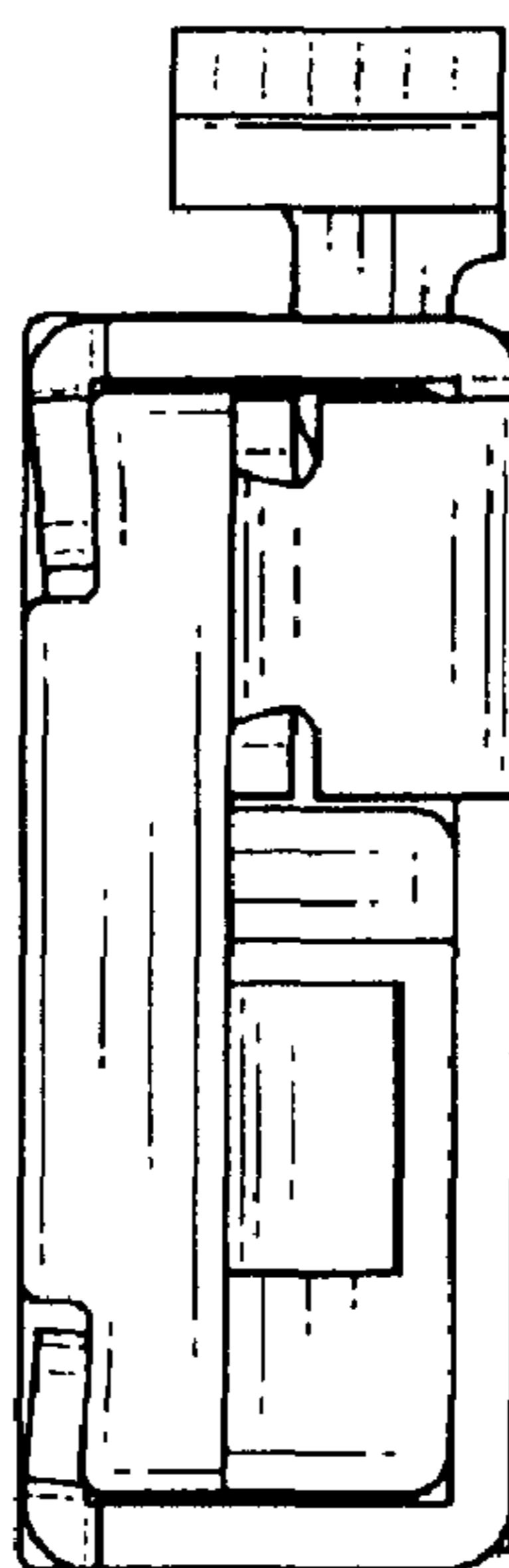

Fig. 7

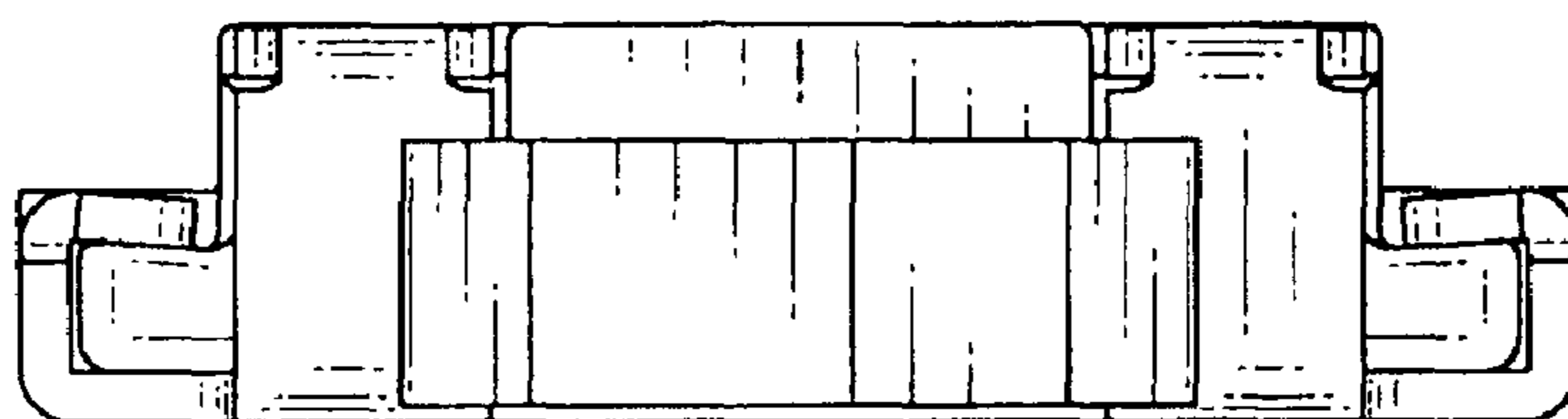

Fig. 8

