



US00D625078S

(12) **United States Design Patent**  
**Scott-Curran**

(10) **Patent No.:** **US D625,078 S**  
(45) **Date of Patent:** **\*\* Oct. 12, 2010**

(54) **SPORTS JERSEY**

(75) Inventor: **Stewart Scott-Curran**, Alderley Edge (GB)

(73) Assignee: **NIKE, Inc.**, Beaverton, OR (US)

(\*\*) Term: **14 Years**

(21) Appl. No.: **29/350,993**

(22) Filed: **Nov. 25, 2009**

(30) **Foreign Application Priority Data**

May 25, 2009 (EM) ..... 001525031

(51) **LOC (9) Cl.** ..... **02-02**

(52) **U.S. Cl.** ..... **D2/717; D2/840**

(58) **Field of Classification Search** ..... D2/717,  
D2/731, 739, 749, 750, 840-842, 844; 2/77,  
2/90, 113, 115, 116

See application file for complete search history.

(56) **References Cited**

**U.S. PATENT DOCUMENTS**

1,468,505 A \* 9/1923 La Rizza ..... 441/112

(Continued)

**OTHER PUBLICATIONS**

iOffer. <http://www.ioffer.com/si/soccer%20jersey>. Date Unknown: Viewed May 2010. Soccer Jersey Netherlands Away World Cup 2010.\*

(Continued)

*Primary Examiner*—Ian Simmons  
*Assistant Examiner*—Rashida Johnson

(74) *Attorney, Agent, or Firm*—TraskBritt

(57) **CLAIM**

The ornamental design for a sports jersey, as shown and described.

**DESCRIPTION**

FIG. 1 is a perspective view of a shirt showing my new design;

FIG. 2 is front view of the shirt shown in FIG. 1;

FIG. 3 is a rear view of the shirt shown in FIG. 1;

FIG. 4 is a first side view of the shirt shown in FIG. 1;

FIG. 5 is a second side view of the shirt shown in FIG. 1;

FIG. 6 is a top view of the shirt shown in FIG. 1; and

FIG. 7 is an enlarged view of a portion of the shirt circumscribed by an uneven broken line in FIG. 3 and identified by the reference number 7; FIG. 7 illustrates the appearance of the fabric of the shirt.

FIG. 8 is a perspective view of a second embodiment of a shirt showing my new design;

FIG. 9 is front view of the shirt shown in FIG. 8;

FIG. 10 is a rear view of the shirt shown in FIG. 8;

FIG. 11 is a first side view of the shirt shown in FIG. 8;

FIG. 12 is a second side view of the shirt shown in FIG. 8;

FIG. 13 is a top view of the shirt shown in FIG. 8; and,

FIG. 14 is an enlarged view of the portion of the shirt circumscribed by an uneven broken line in FIG. 10 and identified by the reference number 14; FIG. 14 illustrates the appearance of the fabric of the shirt.

The uneven broken line representations in FIGS. 3, 7, 10 and 14 are for illustrative purposes only and form no part of the claimed design.

**1 Claim, 12 Drawing Sheets**

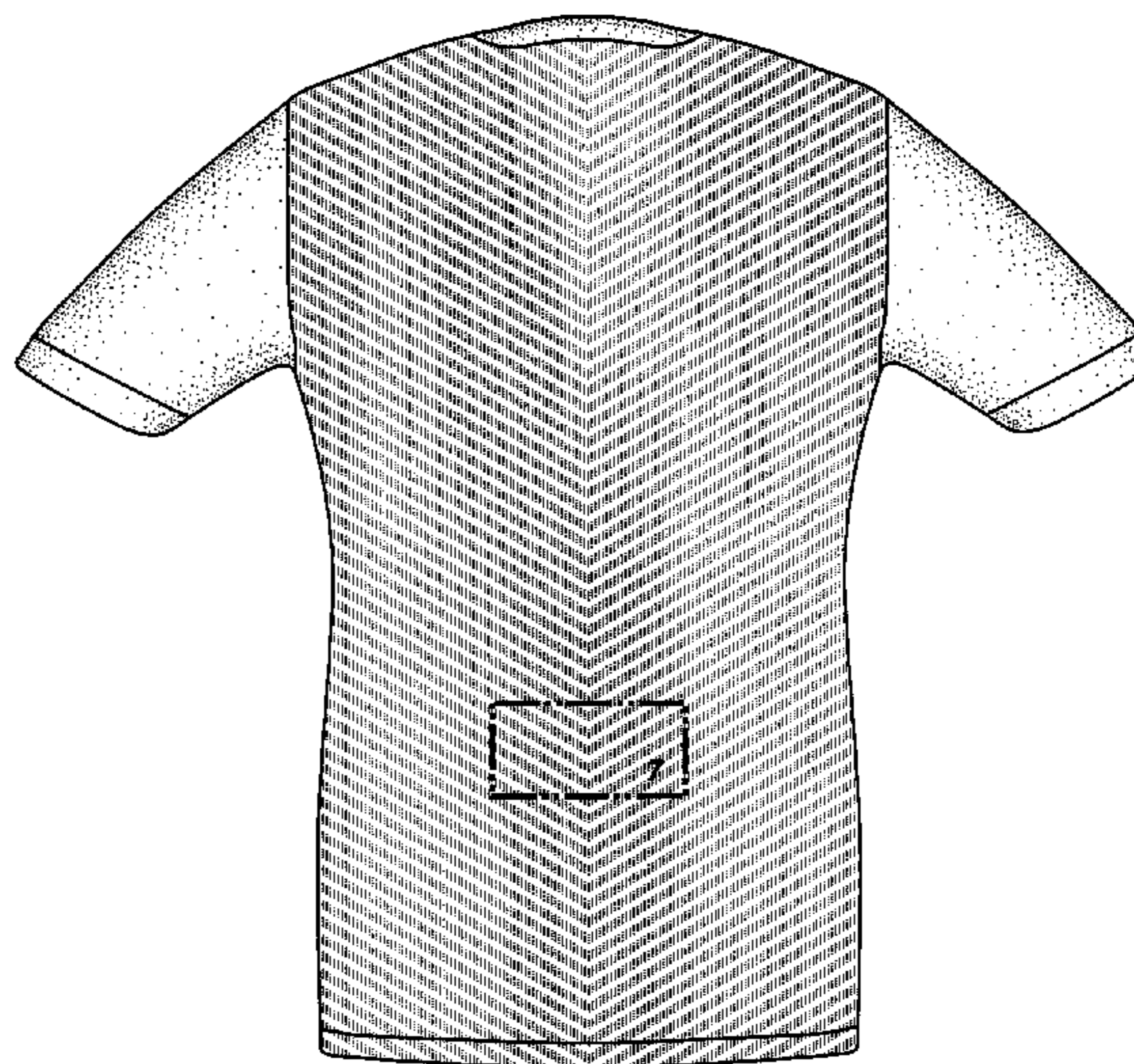
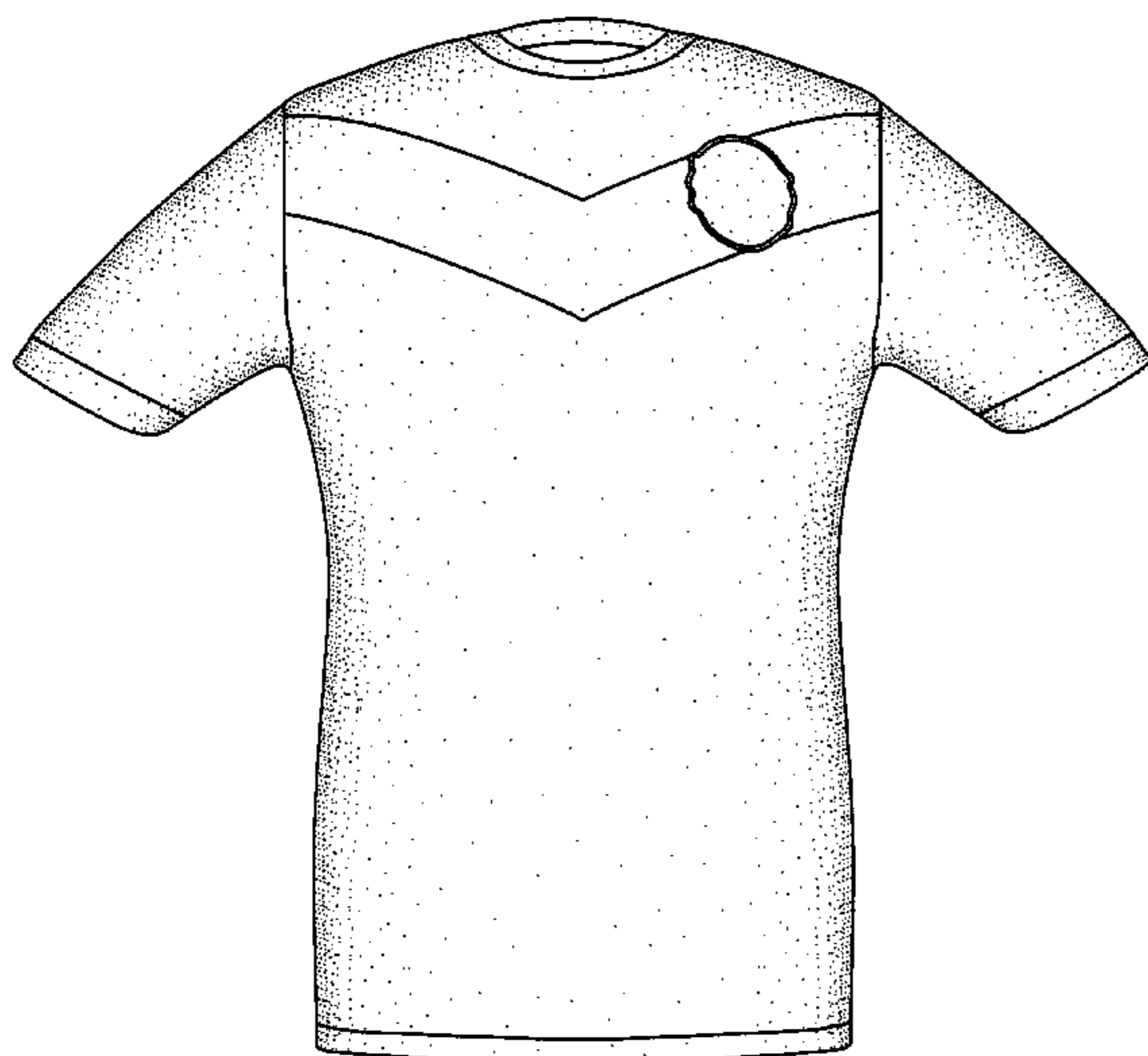

# US D625,078 S

Page 2

---

## U.S. PATENT DOCUMENTS

1,647,656 A \* 11/1927 Olsen ..... 2/115  
D149,369 S \* 4/1948 McKelvey ..... D2/850  
3,484,974 A \* 12/1969 Culmone ..... 40/586  
D286,220 S \* 10/1986 Irwin ..... D2/717  
D290,301 S \* 6/1987 Levy ..... D2/717  
4,698,849 A \* 10/1987 Mitchell et al. .... 2/115  
6,484,325 B1 \* 11/2002 Lazarus et al. .... 2/462  
D517,281 S \* 3/2006 Tanner et al. .... D2/840  
2002/0078485 A1 \* 6/2002 Ferreiro ..... 2/69

2009/0007310 A1\* 1/2009 Armour ..... 2/69

## OTHER PUBLICATIONS

<http://www.jerseys-buy.com/Soccer-Jersey/Shop-by-Country/Germany/Germany-07-09-Home-Soccer-Jersey.html>. Date Unknown: Viewed May 2010. Germany 07-09 Home Soccer Jersey.\*  
Toffs. <http://www.toffs.com/invt/1449>. Wolves 1920 Soccer Jersey.\*  
Toffs. <http://www.toffs.com/invt/1269>. Manchester UTD 1909 Soccer Jersey.\*  
Toffs. <http://www.toffs.com/invt/1511>. West Ham United 1976-1980 Soccer Jersey.\*

\* cited by examiner

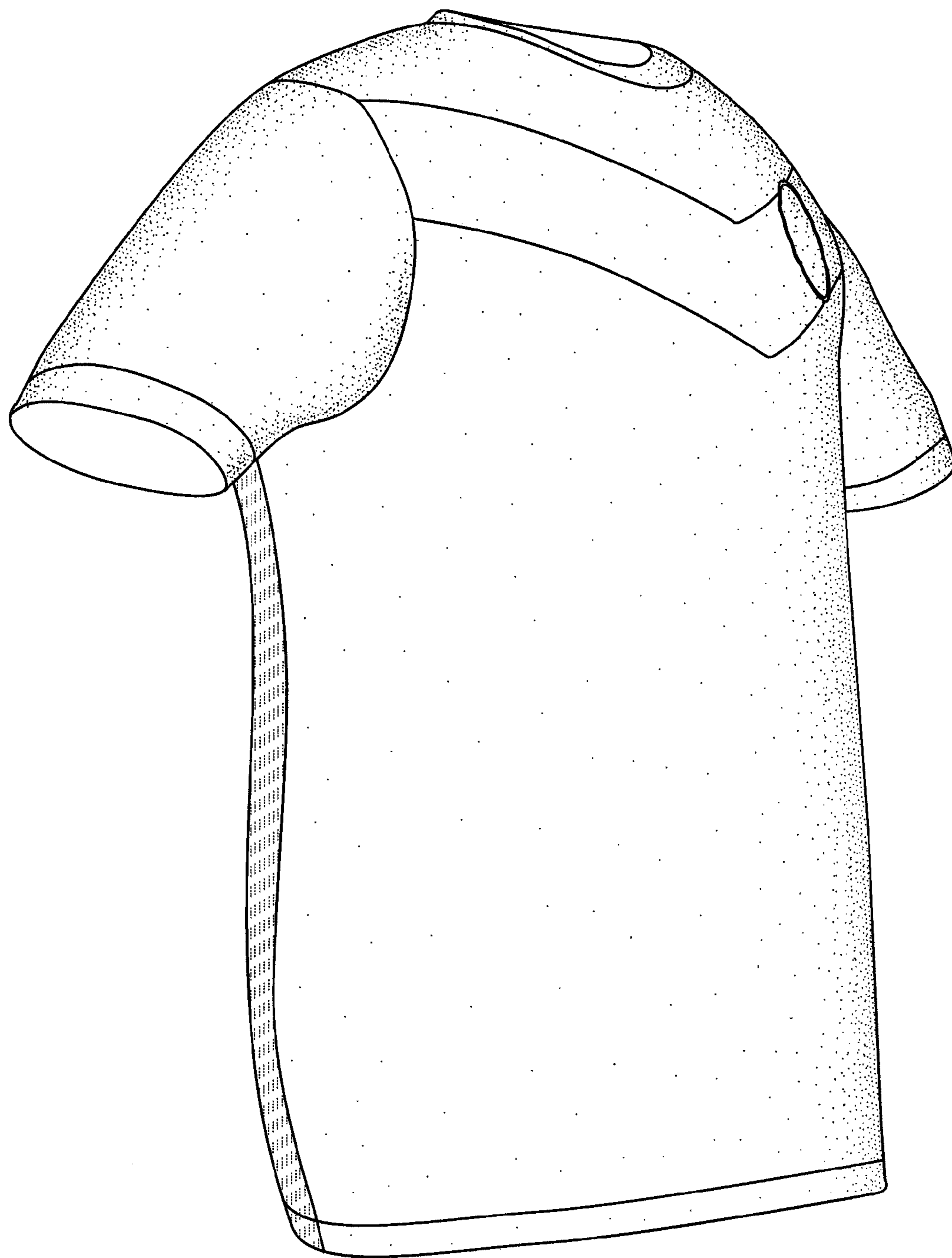

FIG. 1

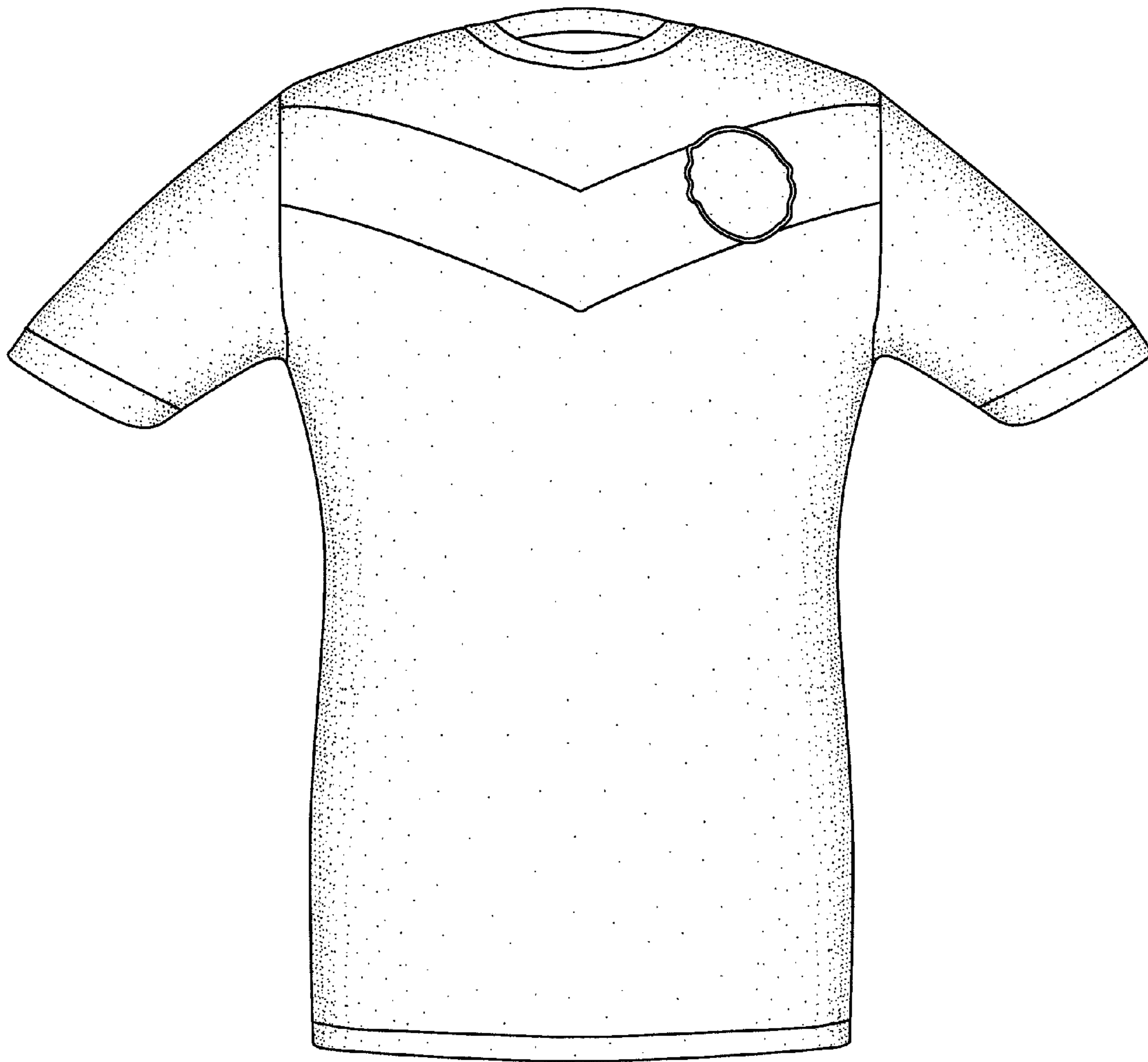

FIG. 2

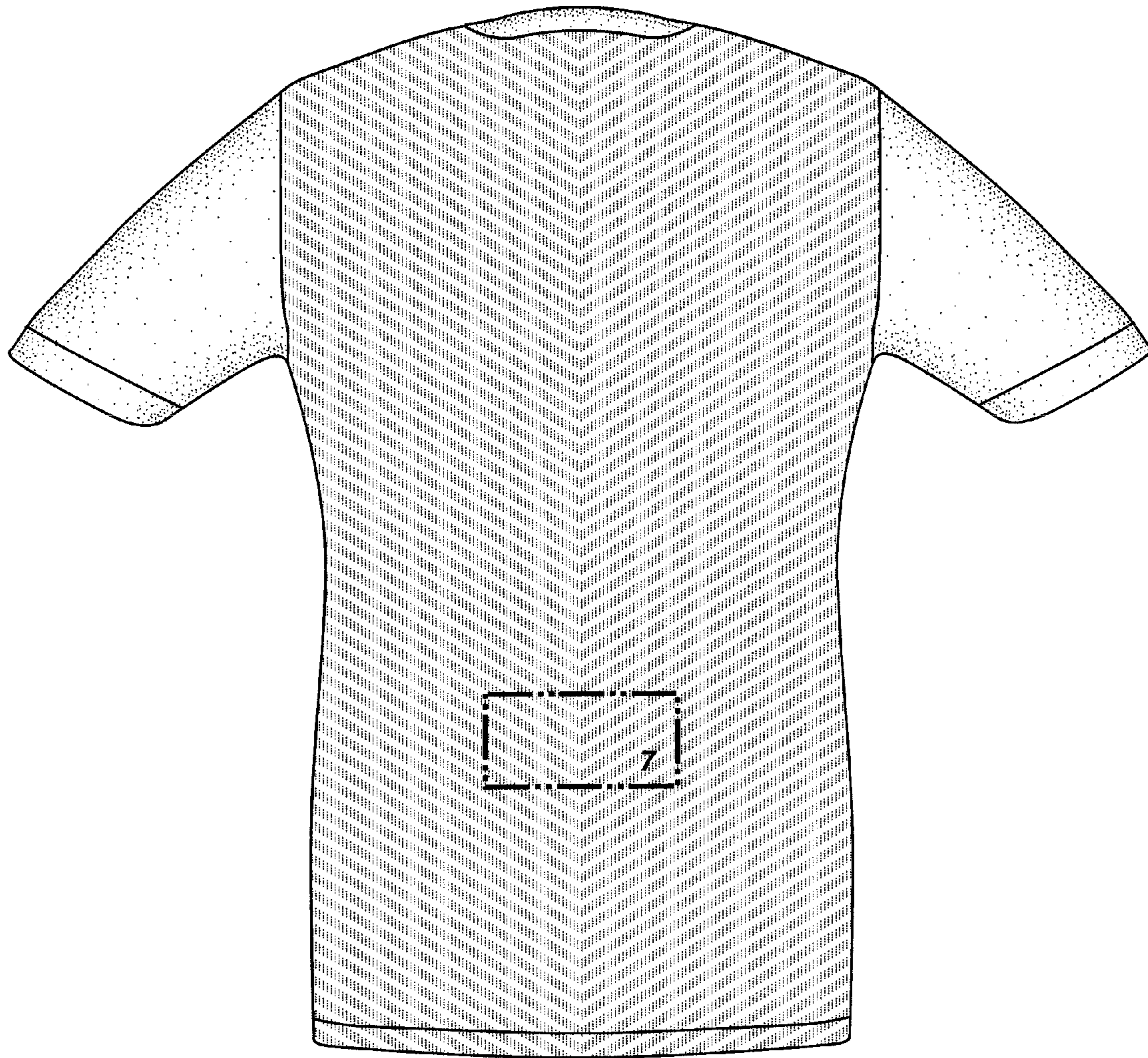

FIG. 3

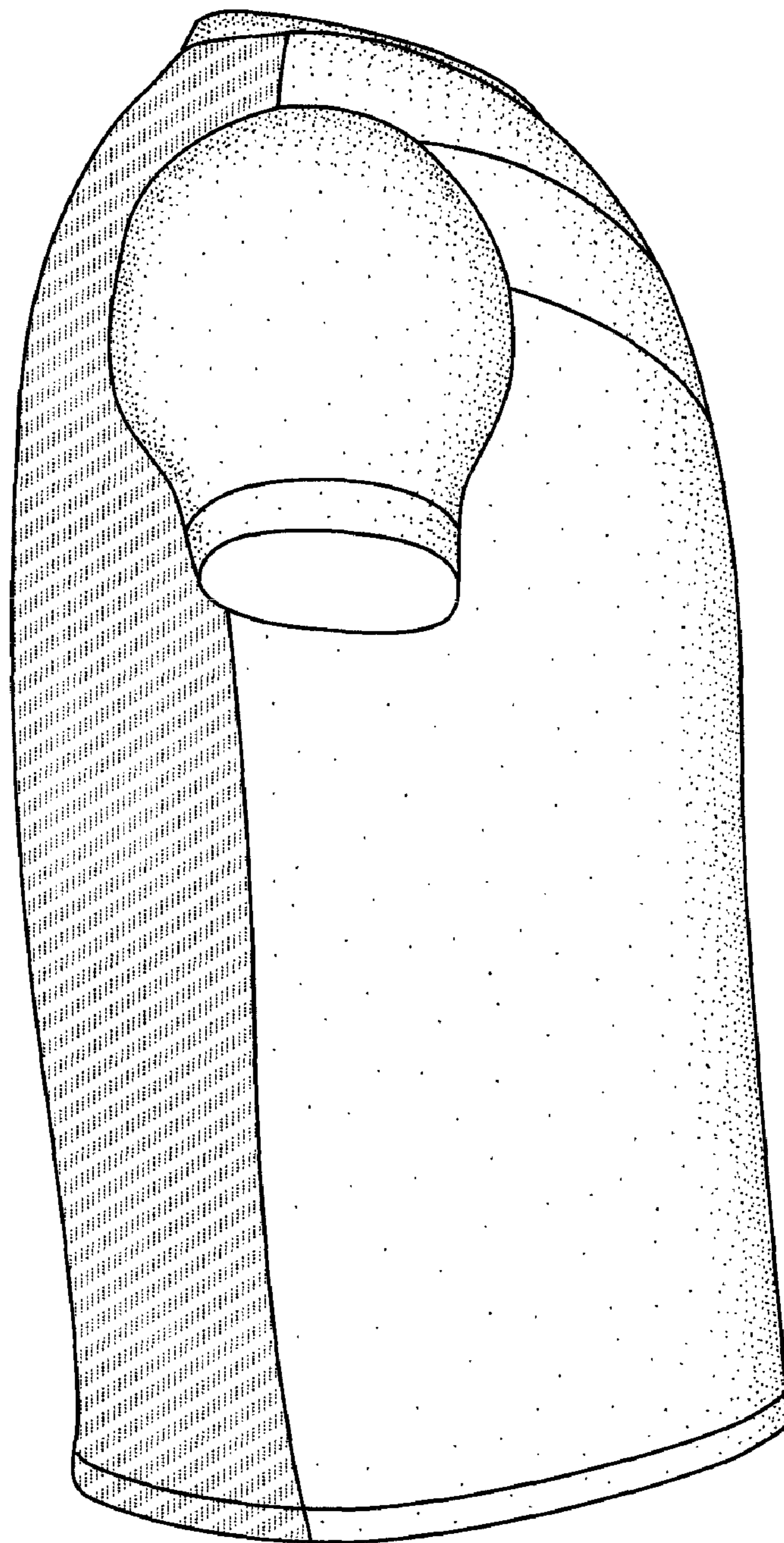

FIG. 4

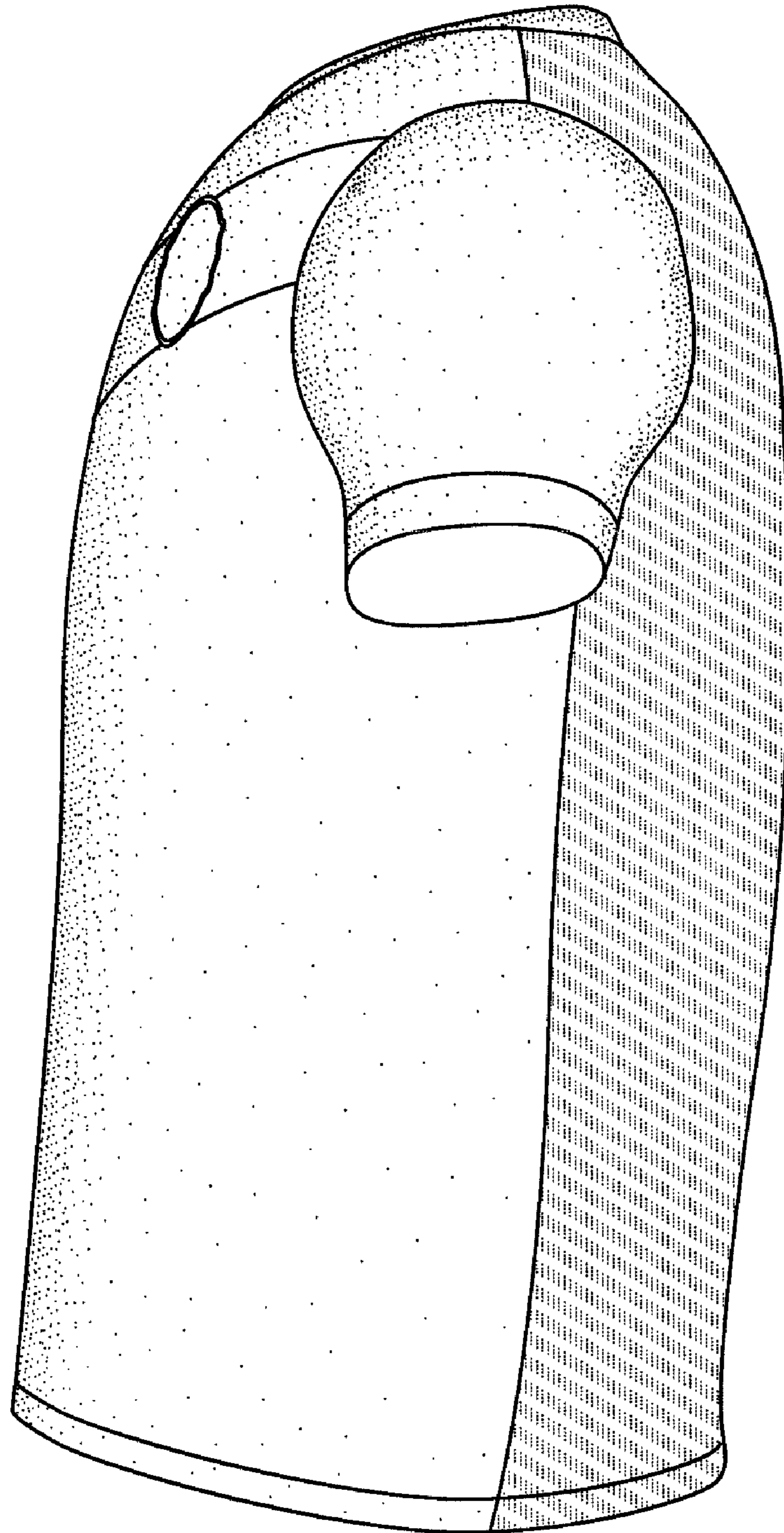

FIG. 5

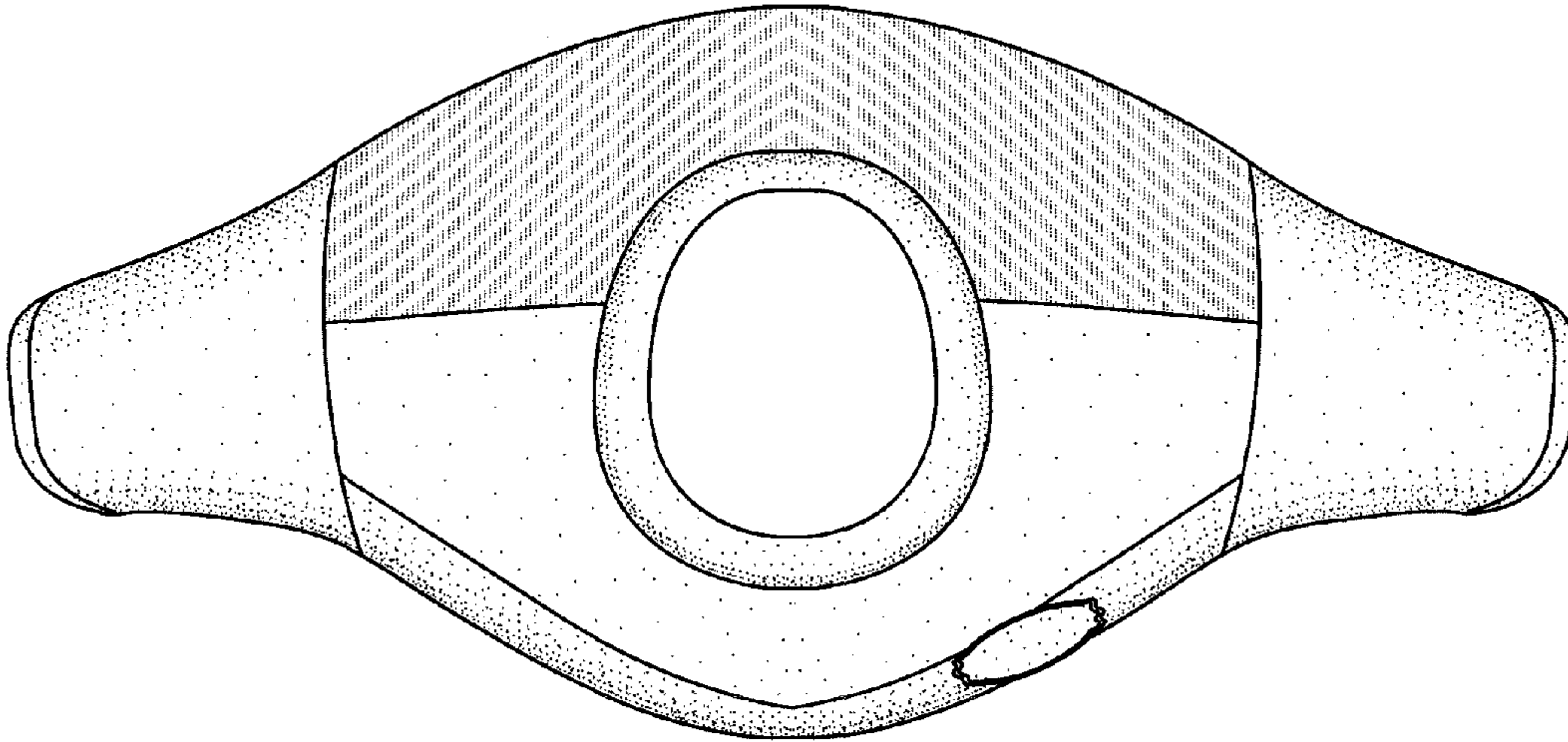

FIG. 6

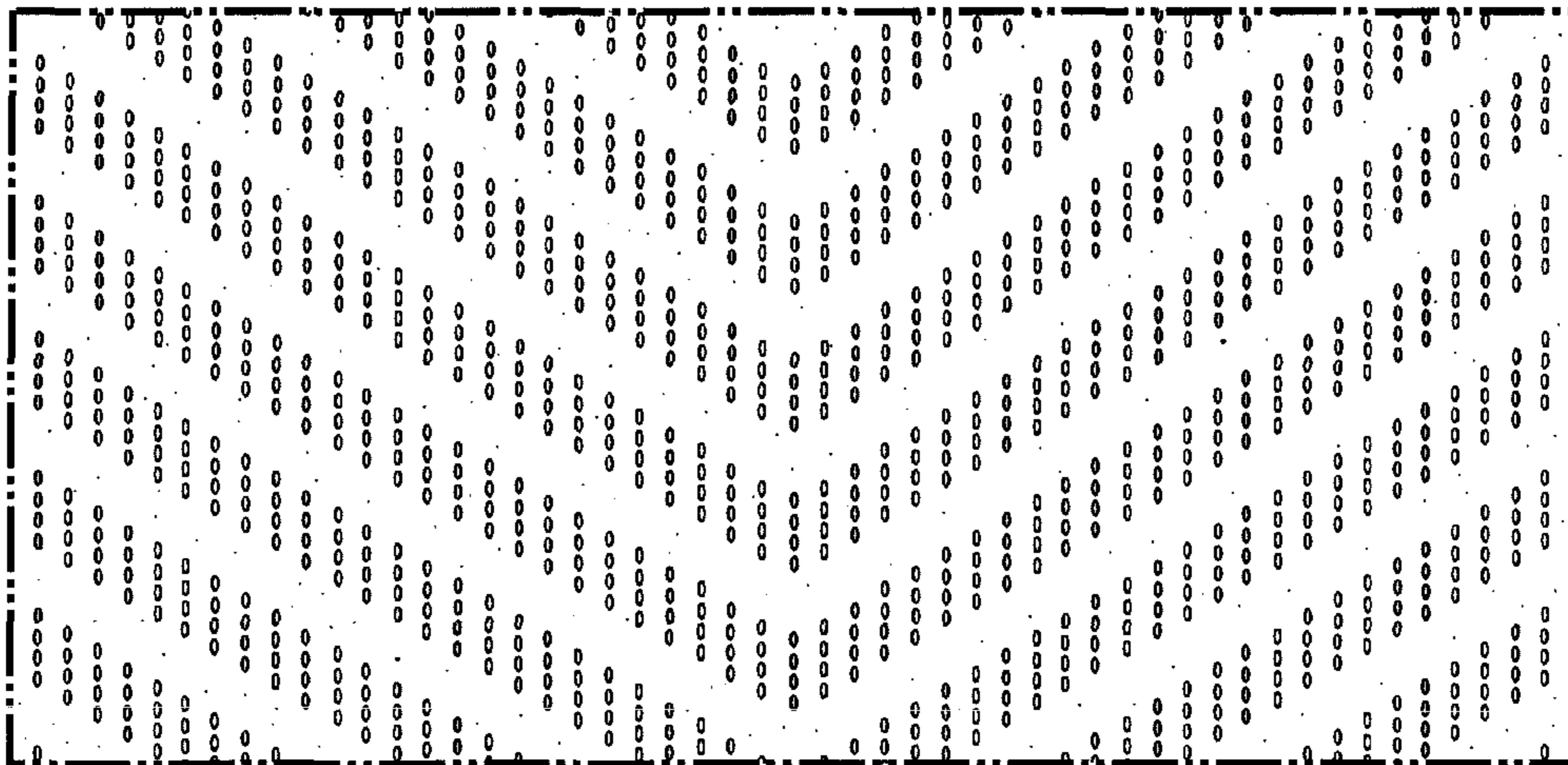

FIG. 7



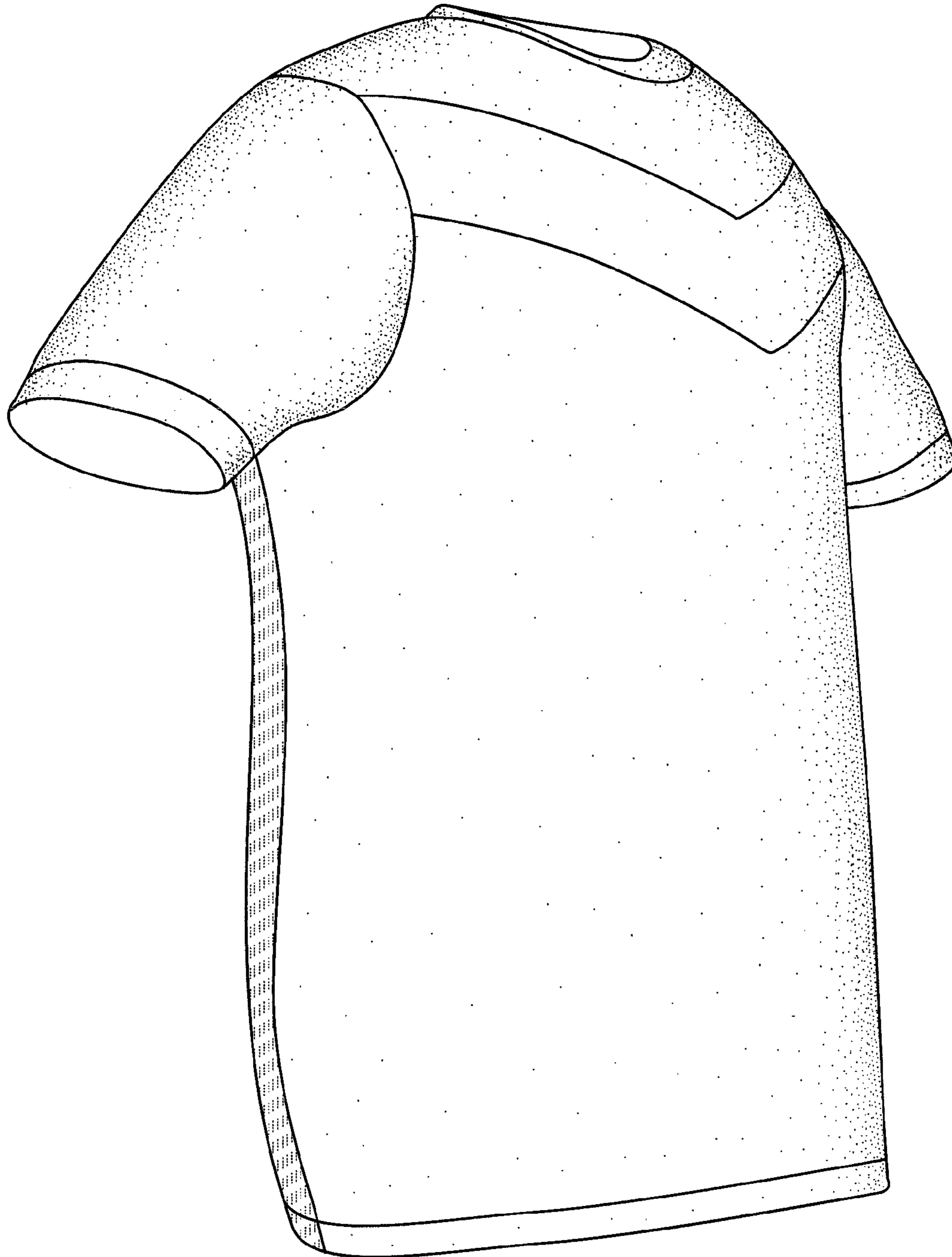

FIG. 8

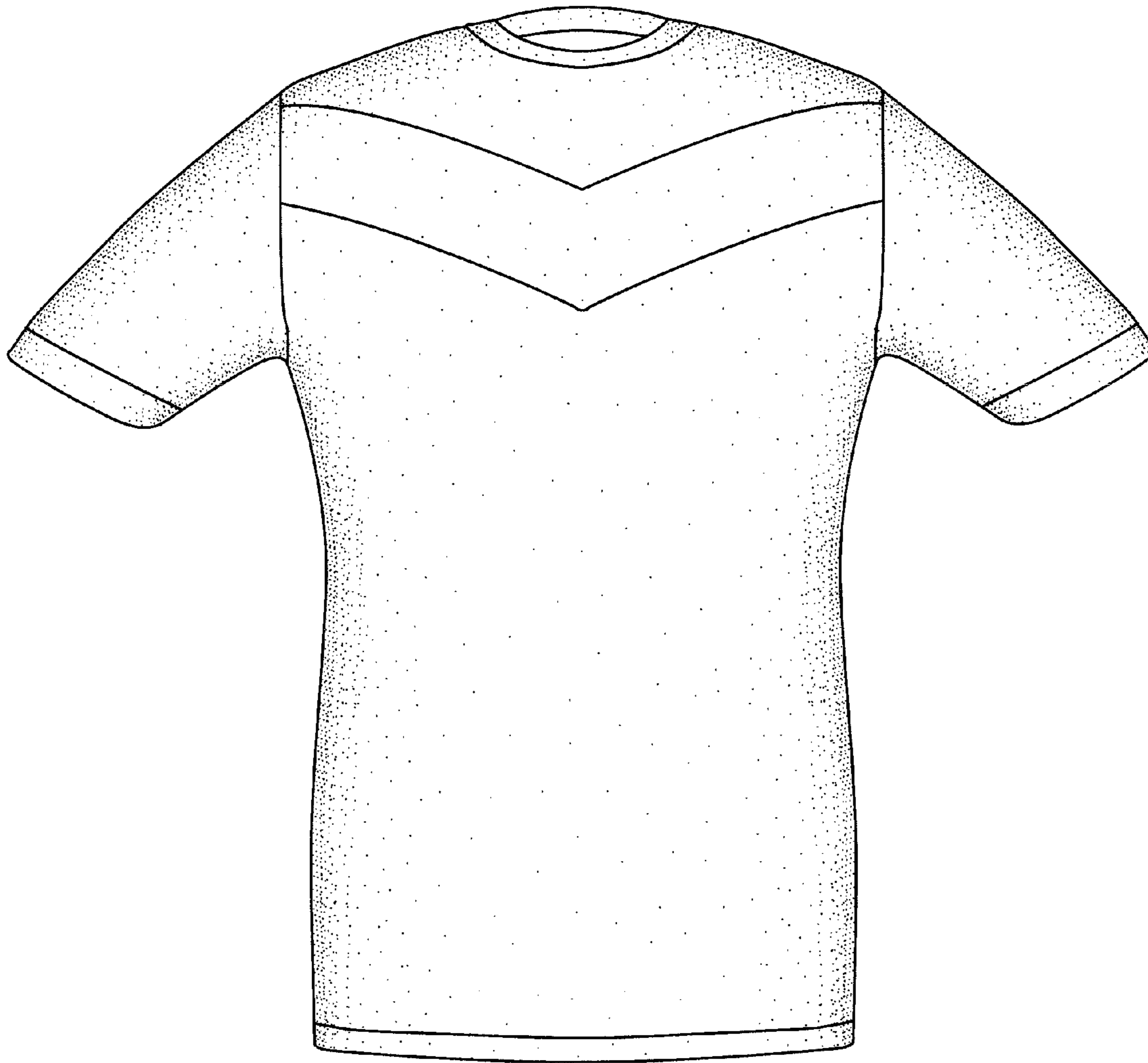
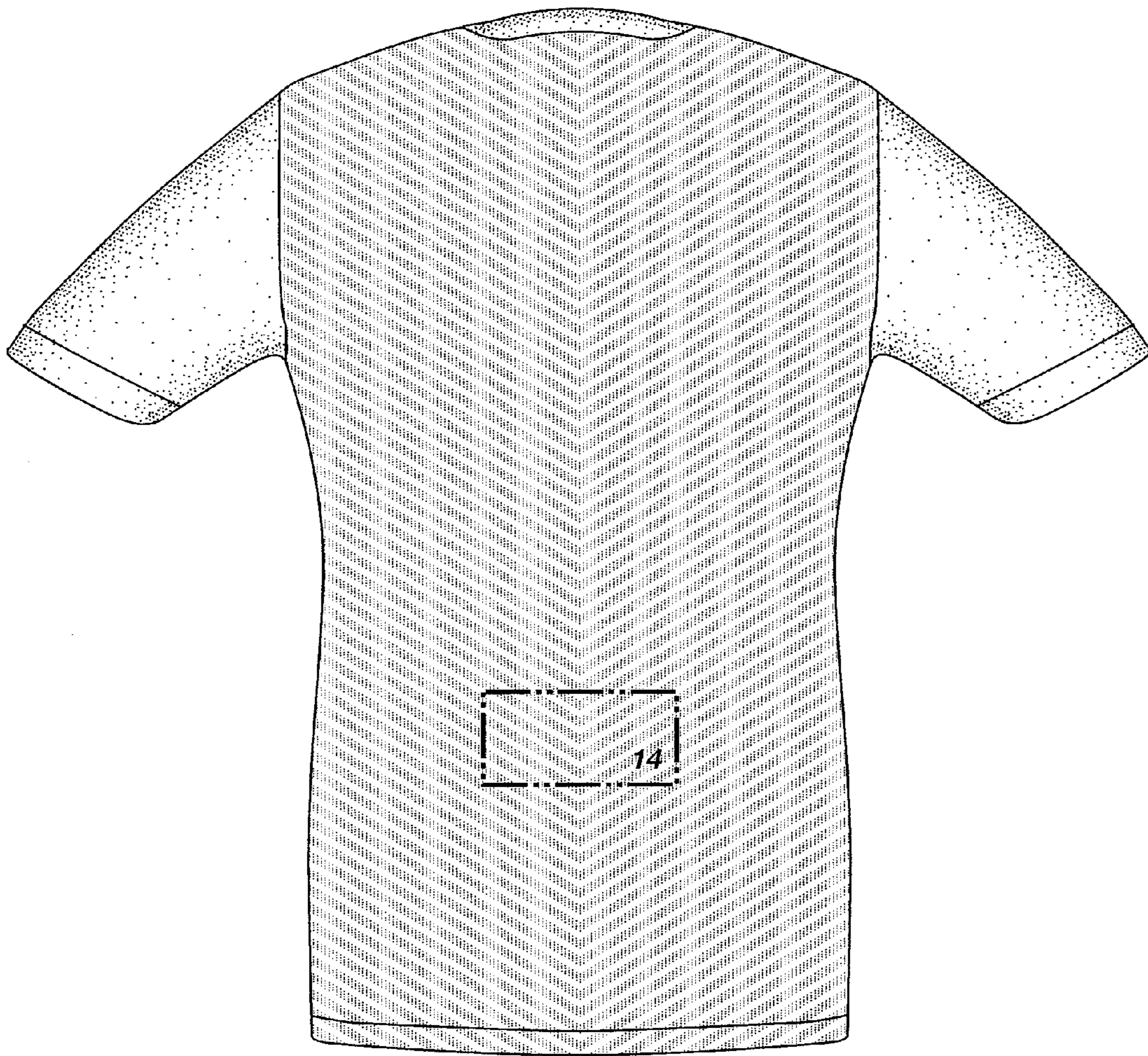

FIG. 9



**FIG. 10**

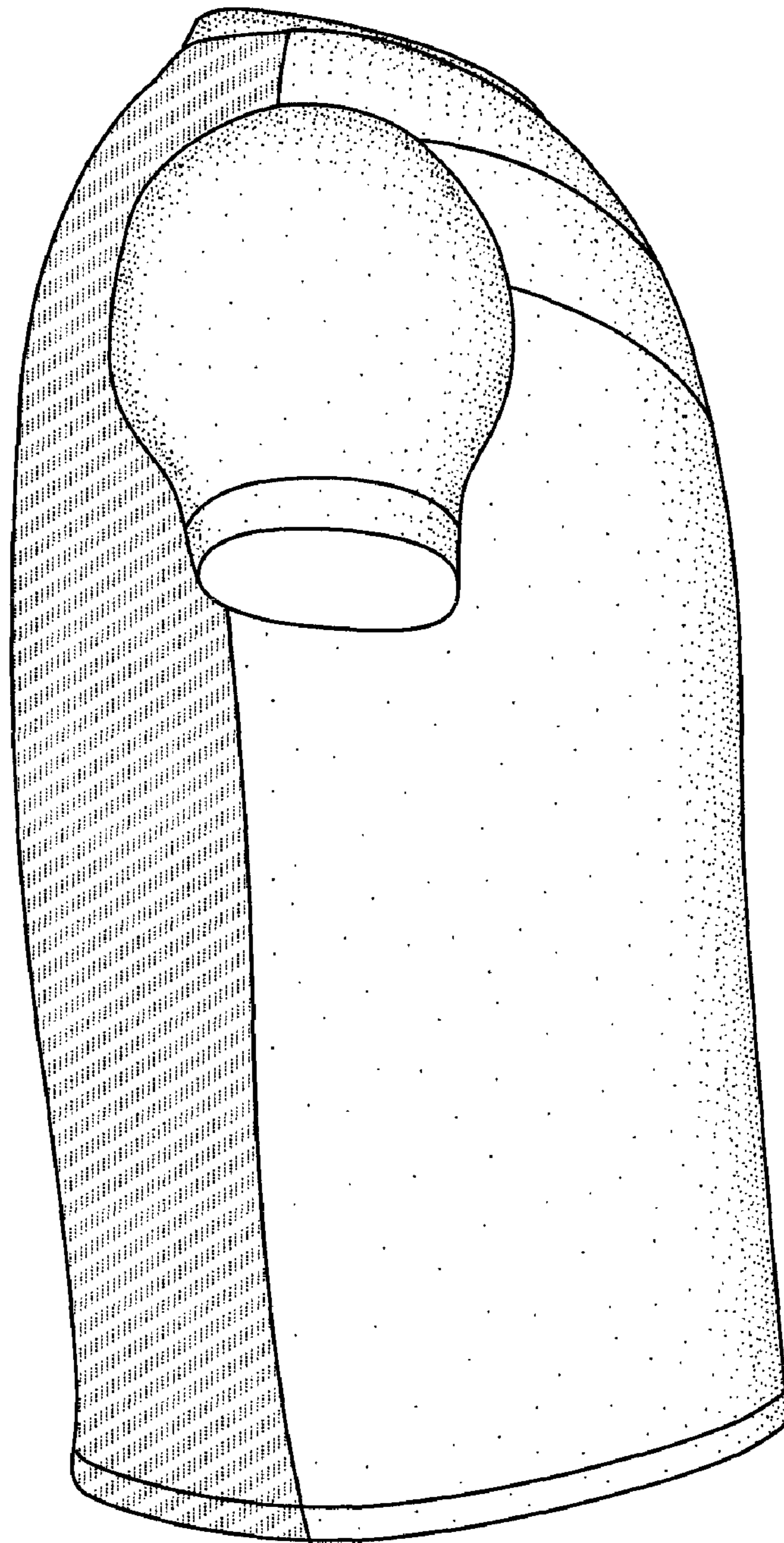

FIG. 11

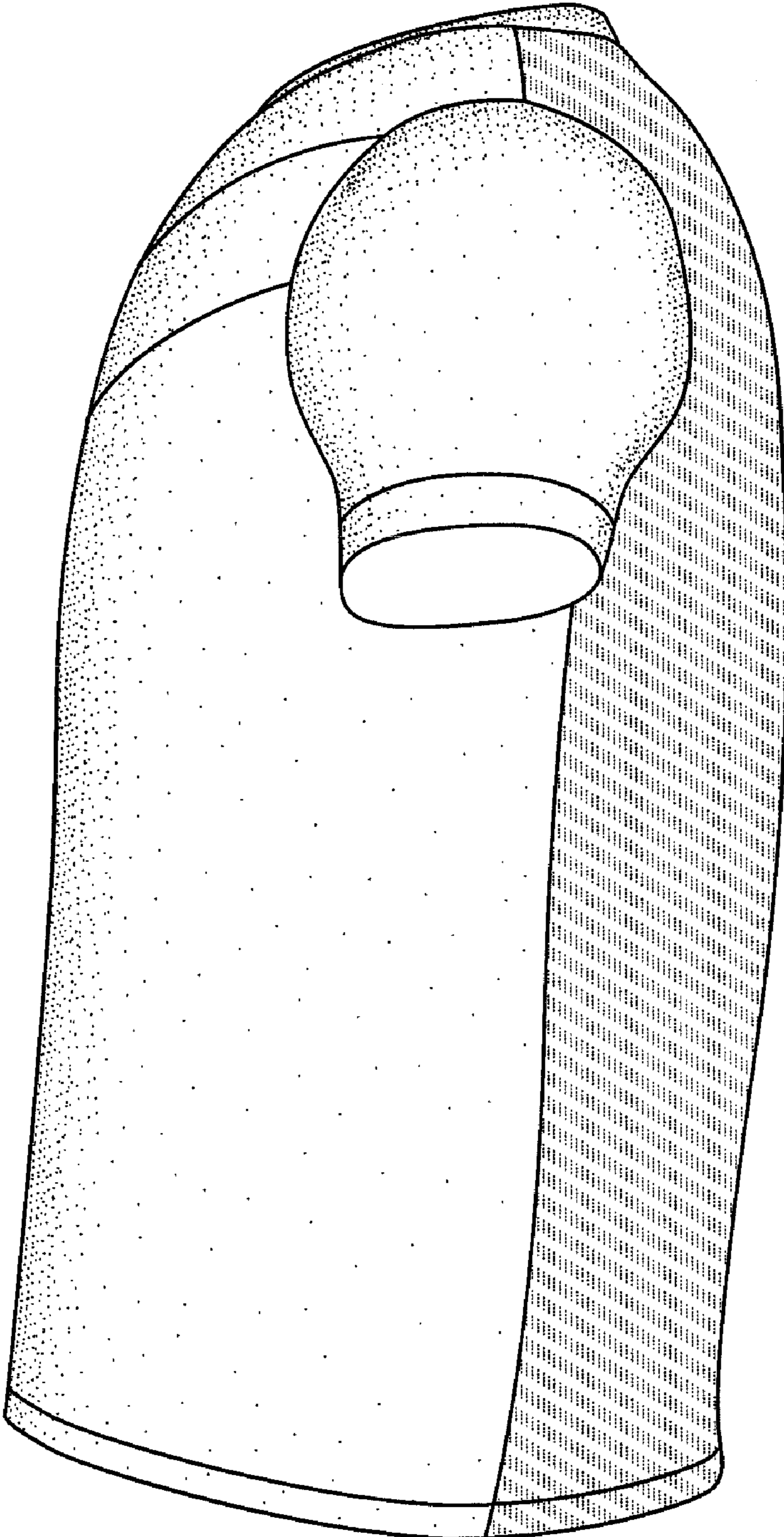

FIG. 12

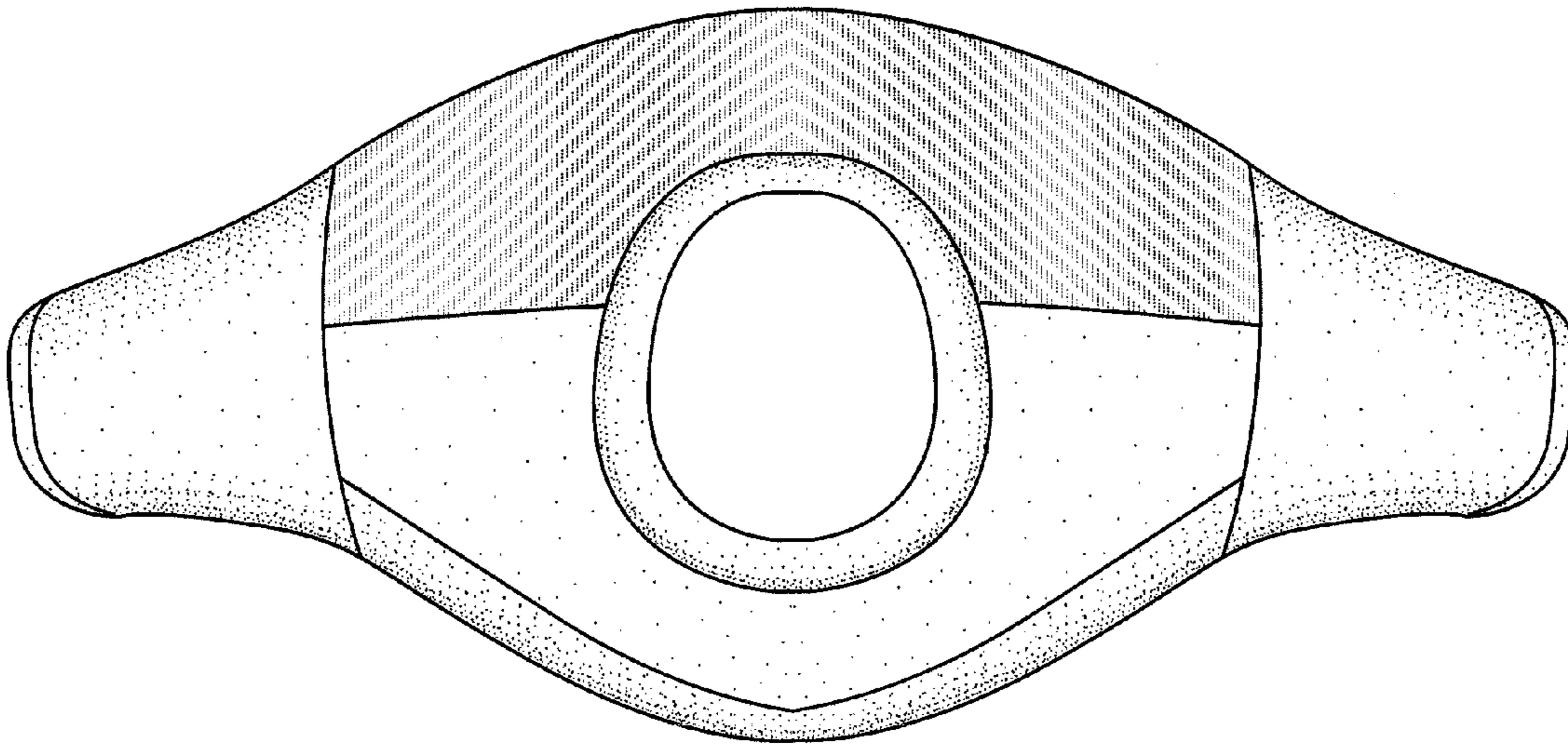

FIG. 13

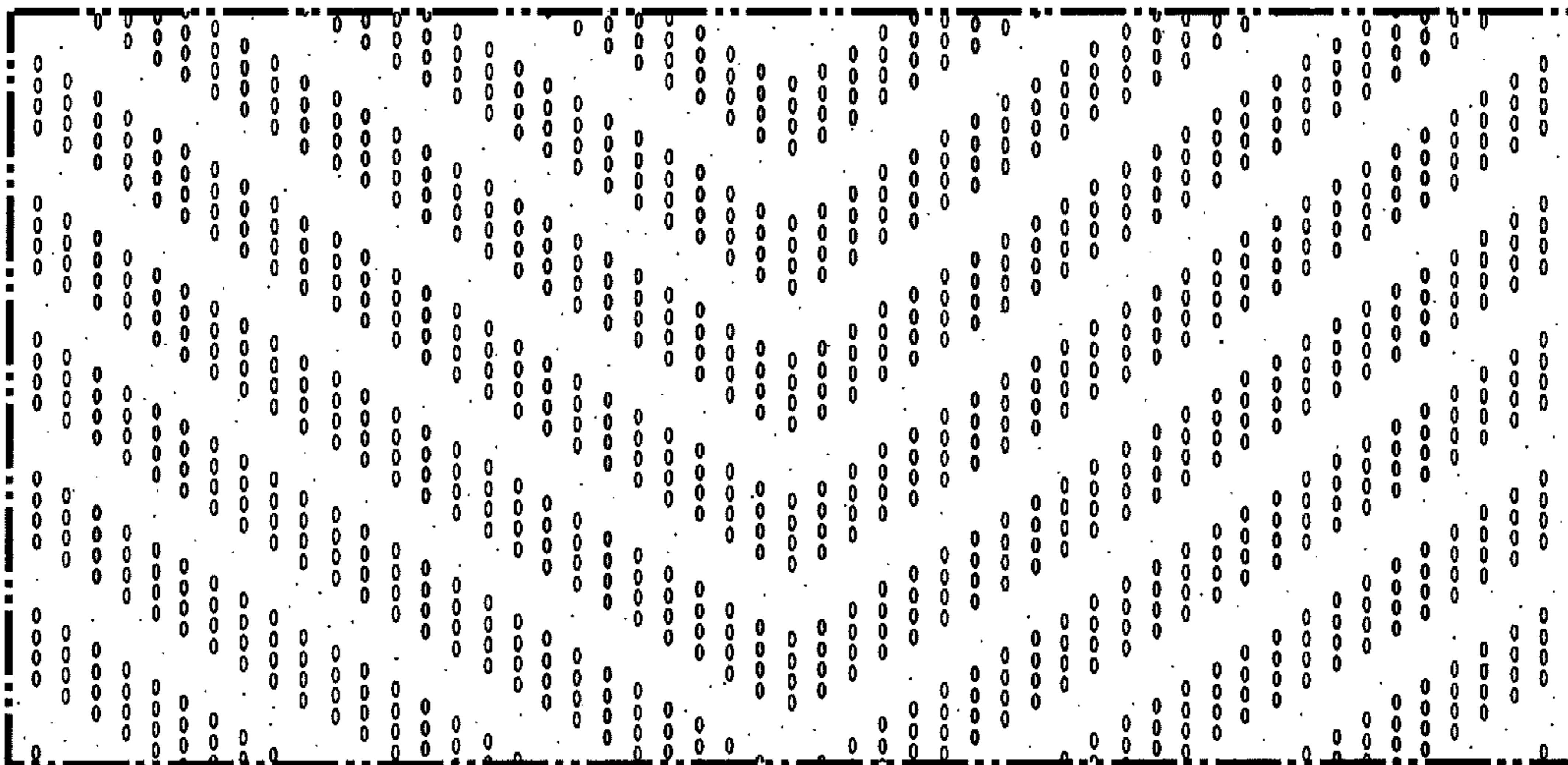

FIG. 14