



US00D624992S

(12) **United States Design Patent**
Maitre et al.

(10) **Patent No.:** **US D624,992 S**
(45) **Date of Patent:** **** Oct. 5, 2010**

(54) **PLUMBING FIXTURE**

(75) Inventors: **Hubert Maitre**, Saint Cyr l'Ecole (FR);
Christophe Gouy, Le Latet (FR)

(73) Assignee: **Kohler France SAS**, Paris (FR)

(**) Term: **14 Years**

(21) Appl. No.: **29/339,189**

(22) Filed: **Jun. 25, 2009**

(30) **Foreign Application Priority Data**

Dec. 31, 2008 (EP) 001064604-0001-0005

(51) **LOC (9) Cl.** **23-02**

(52) **U.S. Cl.** **D23/284**

(58) **Field of Classification Search** D23/284-285,
D23/293.1, 308; 4/619, 631, 650, 660

See application file for complete search history.

(56) **References Cited**

U.S. PATENT DOCUMENTS

D545,413 S * 6/2007 Lin et al. D23/293.1
D588,242 S * 3/2009 Hanna D23/284
D588,679 S * 3/2009 Cheng D23/287
D588,680 S * 3/2009 Cheng D23/287

OTHER PUBLICATIONS

Kohler Co. "Sana of Burg", Kohler Co. catalog.
WS Bath Collections, "Limbos 1—Birch/Oak Wood",
HomePortfolio.com online catalog. Copyright 1997-2008
HomePortfolio Inc.

* cited by examiner

Primary Examiner—Robert A Delehanty
(74) *Attorney, Agent, or Firm*—Quarles & Brady LLP

(57) **CLAIM**

The ornamental design for a plumbing fixture, as shown and described.

DESCRIPTION

FIG. 1 is a right, top, front perspective view of a plumbing fixture embodying our new design;

FIG. 2 is a top plan view thereof;

FIG. 3 is a front elevational view thereof;

FIG. 4 is a right side elevational view thereof, the left: side elevational view thereof being a mirror image of the right side shown;

FIG. 5 is a rear elevational view thereof;

FIG. 6 is a bottom plan view thereof;

FIG. 7 is a left, top, front perspective view of a plumbing fixture according to another embodiment of our new design, the top plan, front elevational, right side elevational, rear elevational and bottom plan views thereof being mirror images of respective FIGS. 2-6;

FIG. 8 is a right, top, front perspective view of a plumbing fixture according to another embodiment of our new design;

FIG. 9 is a top plan view thereof;

FIG. 10 is a front elevational view thereof

FIG. 11 is a right side elevational view thereof, the left side elevational view thereof being a mirror image of the right side shown;

FIG. 12 is a rear elevational view thereof;

FIG. 13 is a bottom plan view thereof; and,

FIG. 14 is a left, top, front perspective view of a plumbing fixture according to another embodiment of our new design, the top plan, front elevational, right side elevational, rear elevational and bottom plan views thereof being mirror images of respective FIGS. 9-13.

The broken line representations in the figures, including the platform environment shown in FIGS. 1, 7, 8 and 14, are for the purpose of illustration only, and form no part of the claimed design.

In a preferred embodiment, the nature of this product is a plumbing fixture, such as a lavatory table with a basin for use in washing various items.

1 Claim, 10 Drawing Sheets

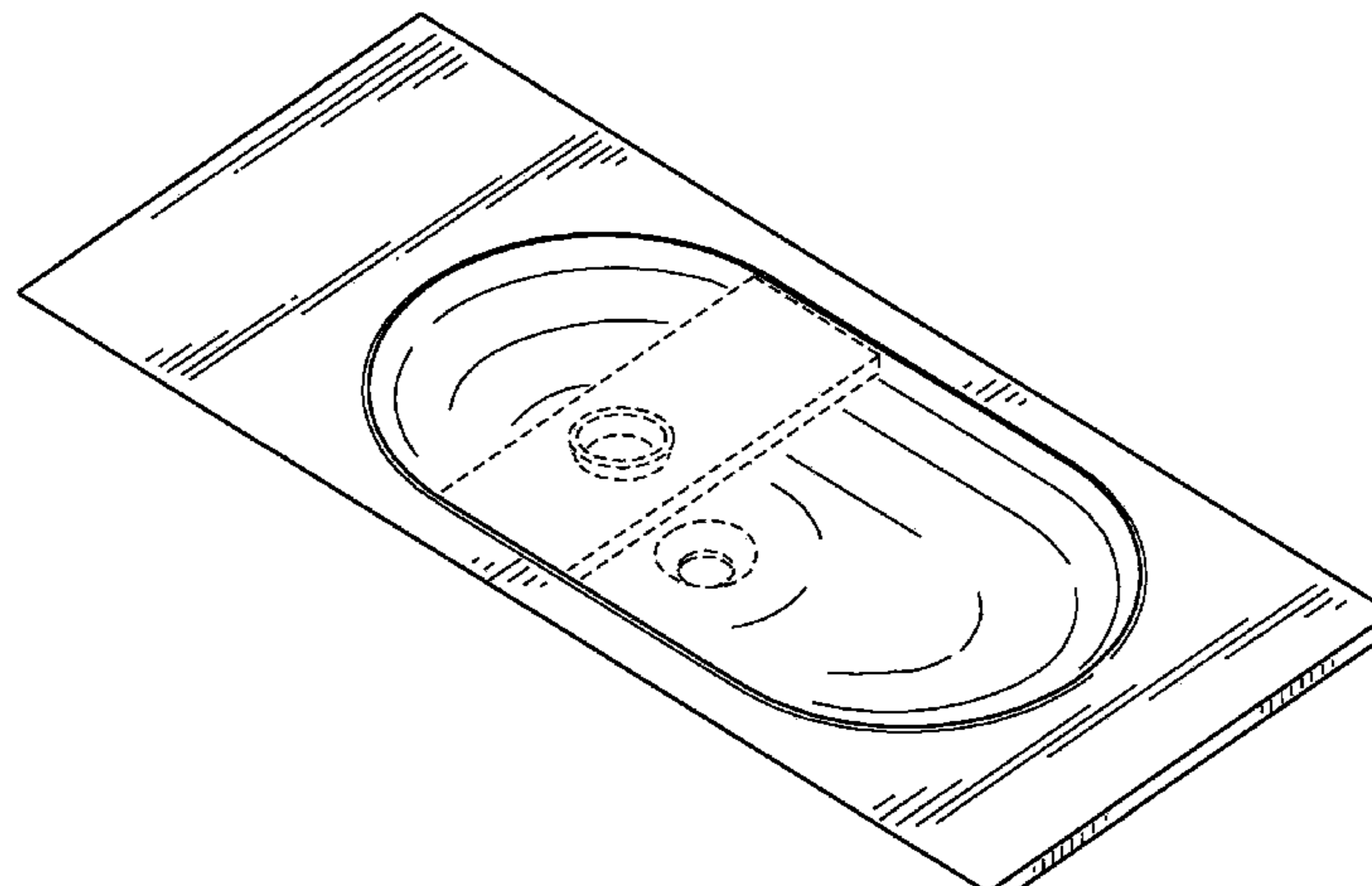

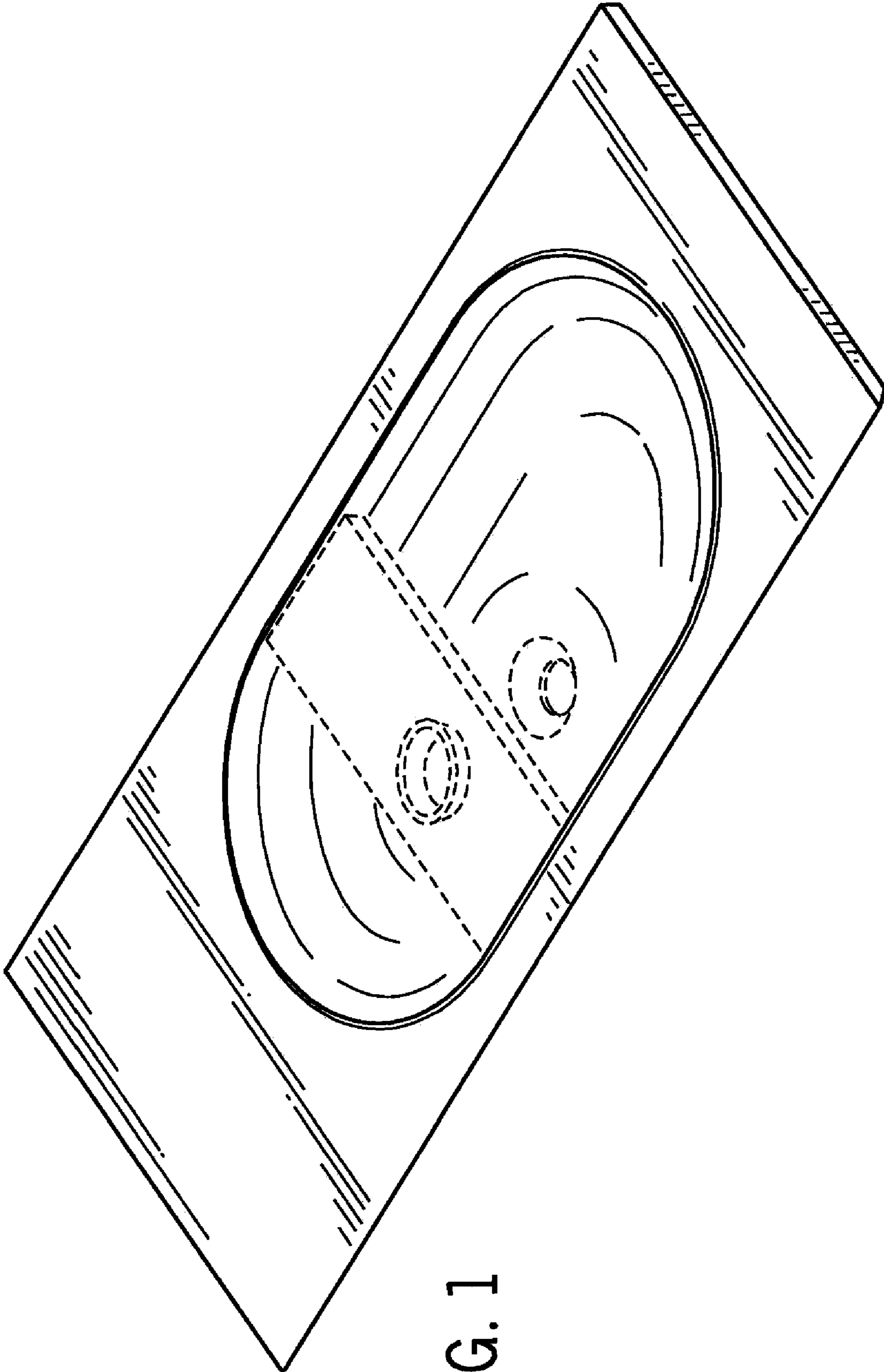

FIG. 1

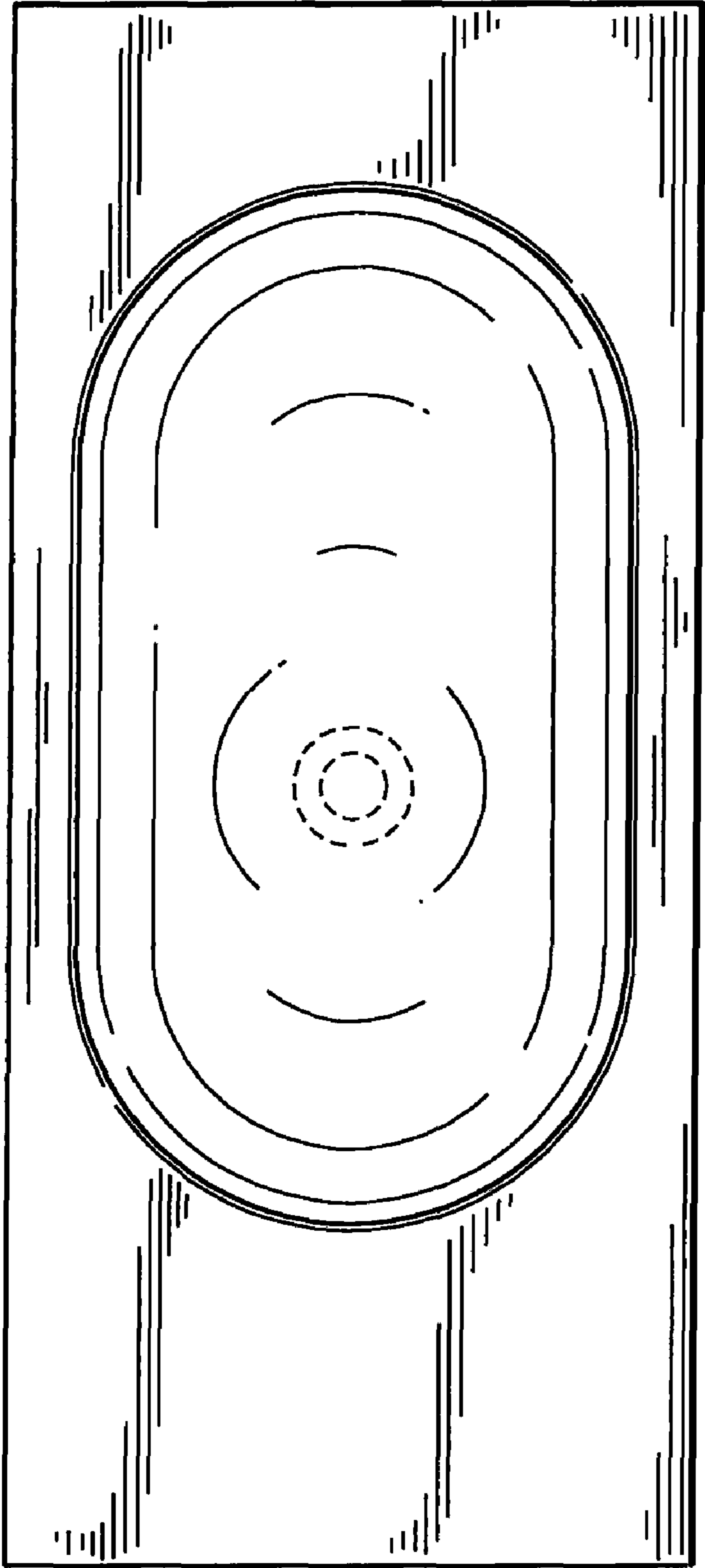

FIG. 2

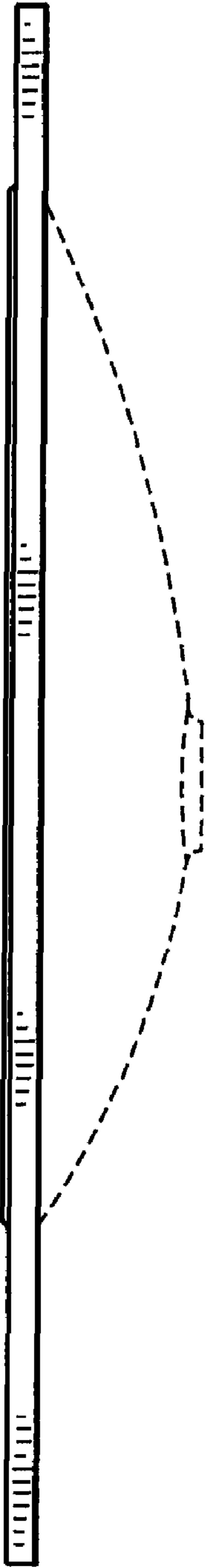

FIG. 3



FIG. 4



FIG. 5

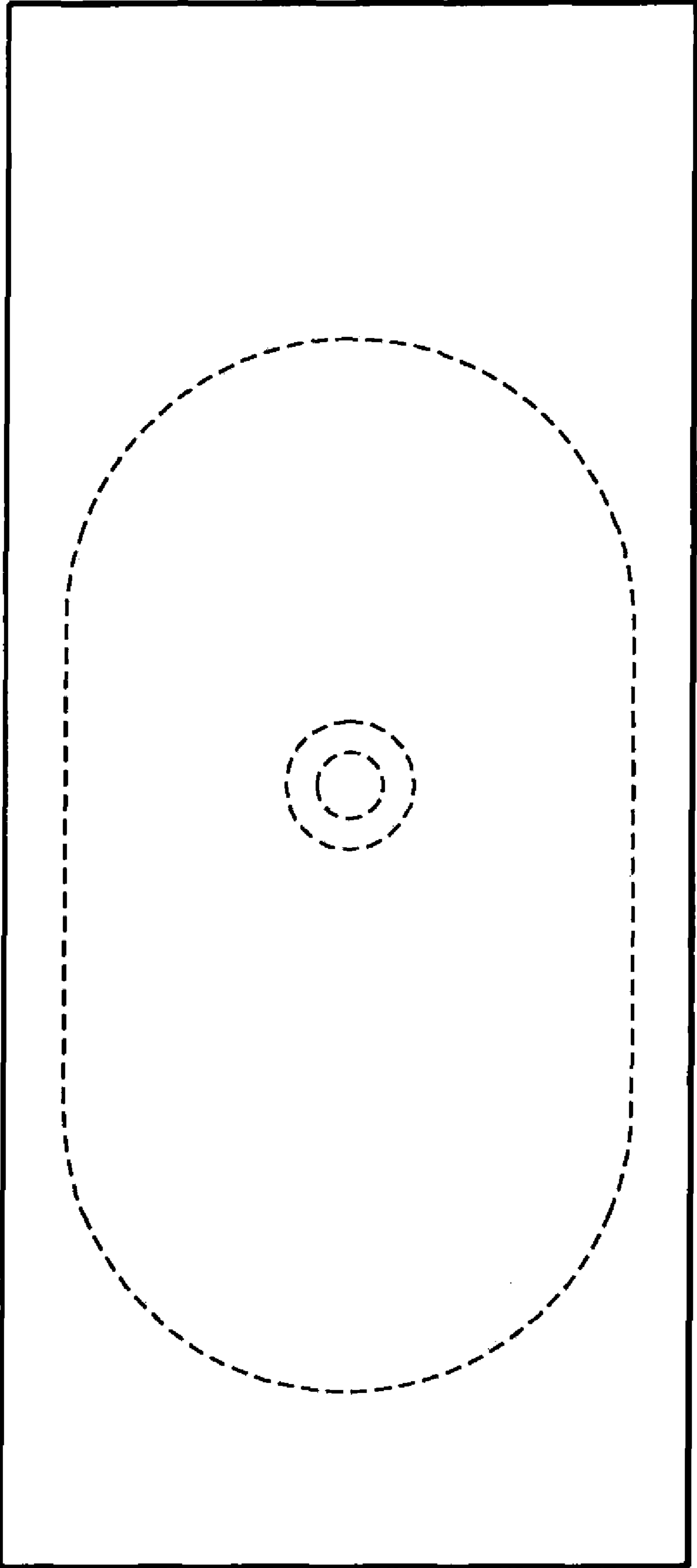

FIG. 6

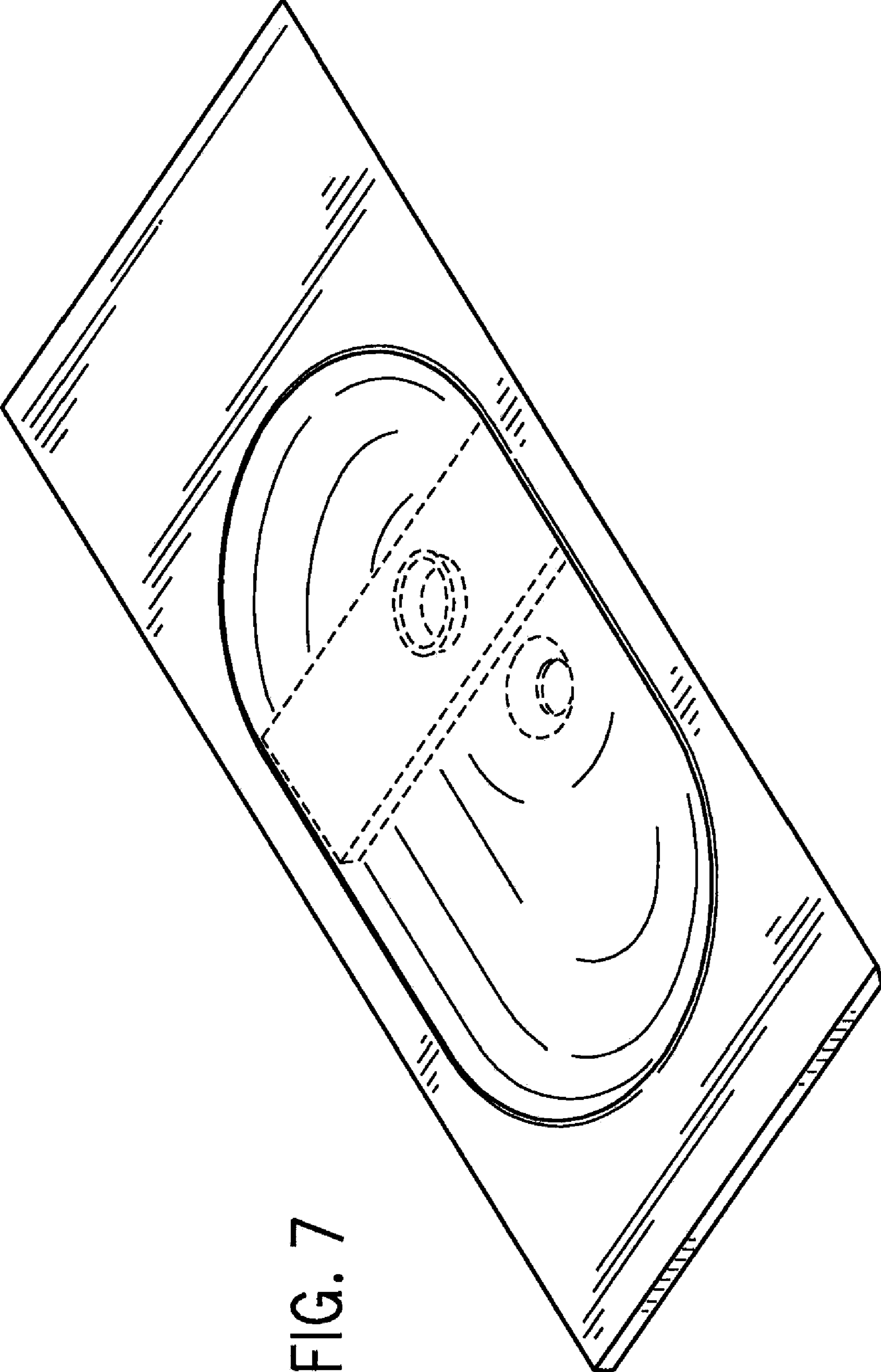

FIG. 7

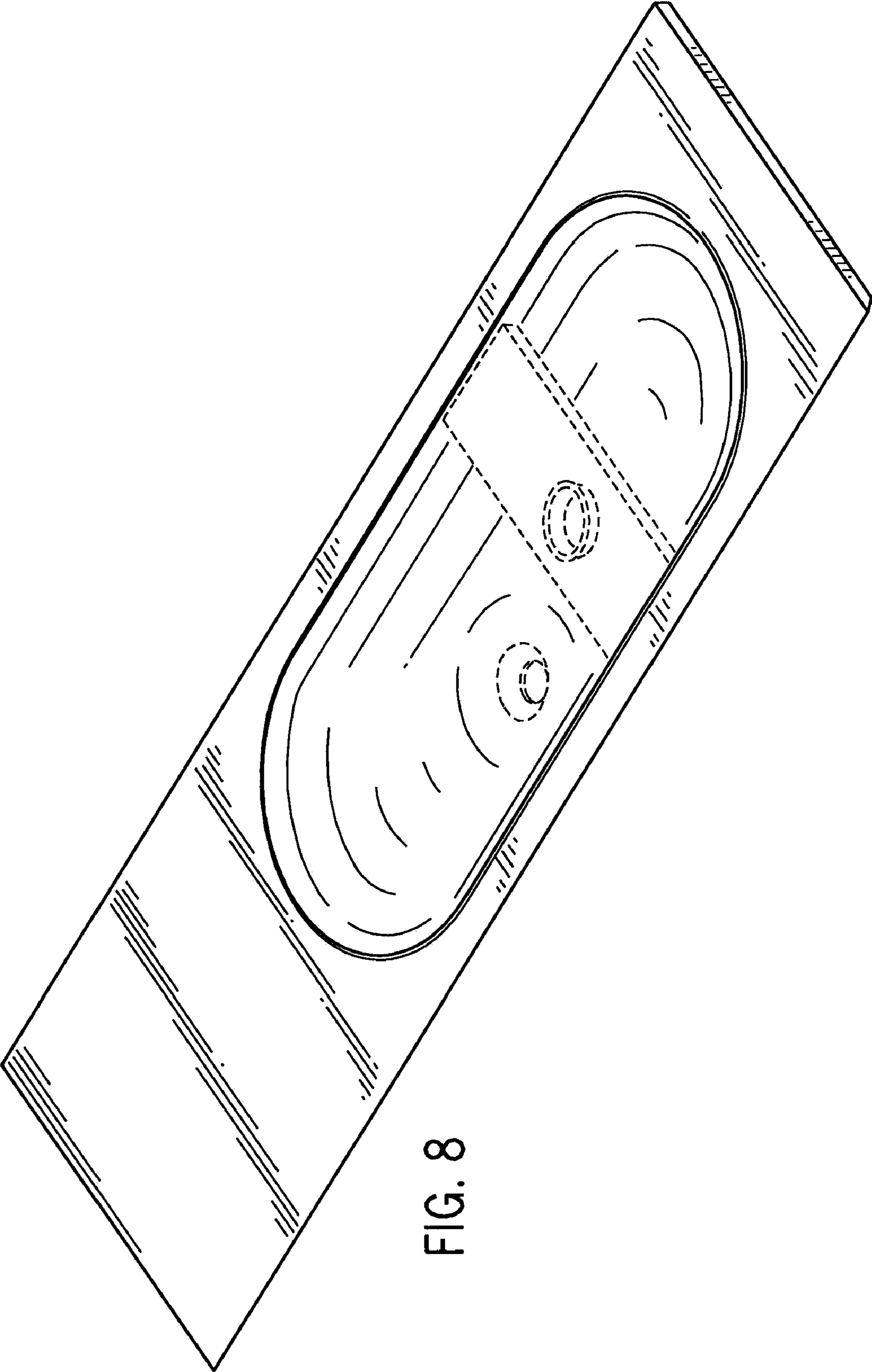

FIG. 8

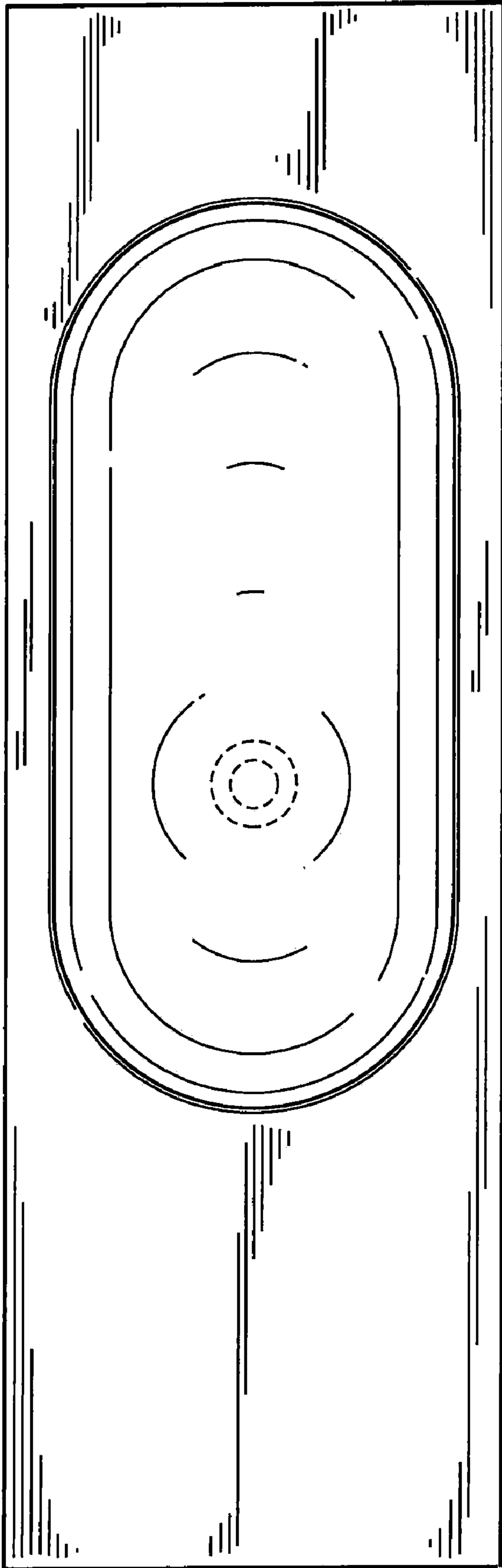

FIG. 9

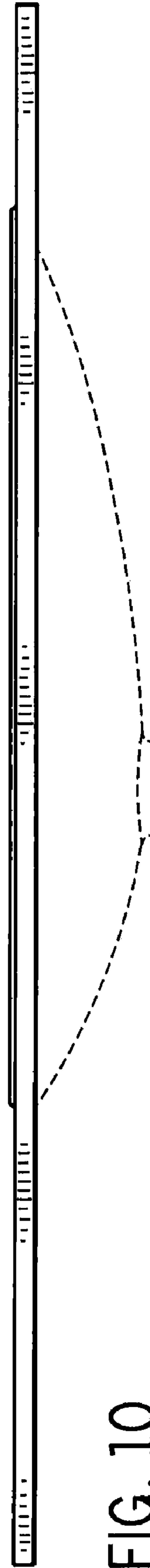

FIG. 10

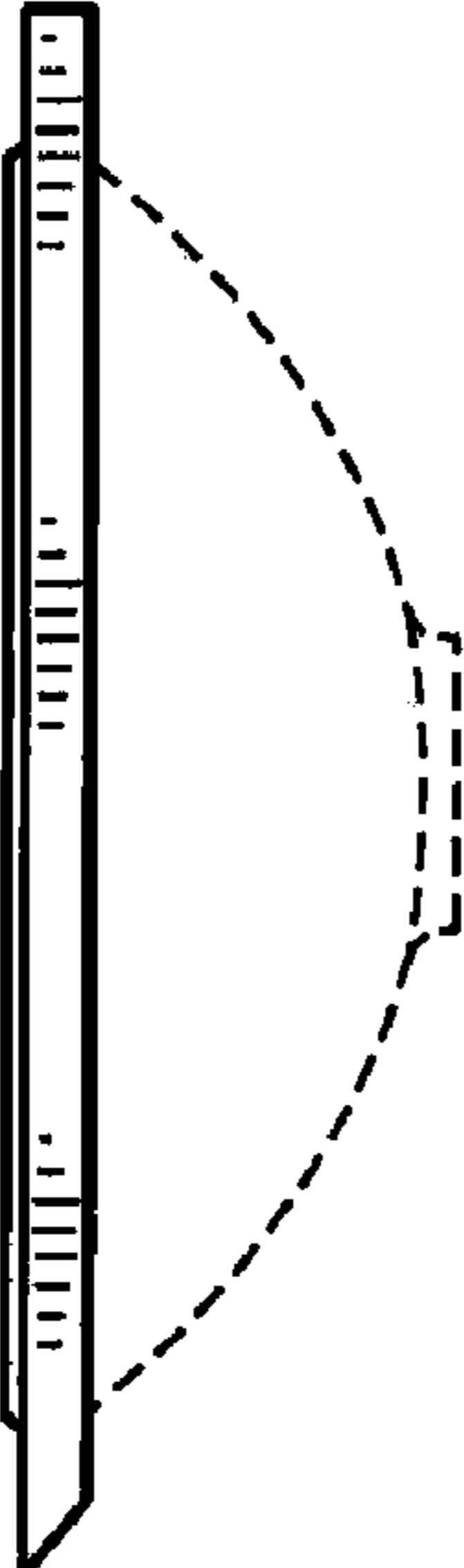

FIG. 11

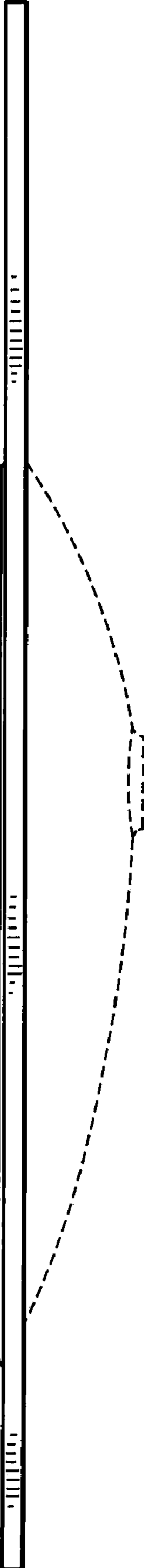

FIG. 12

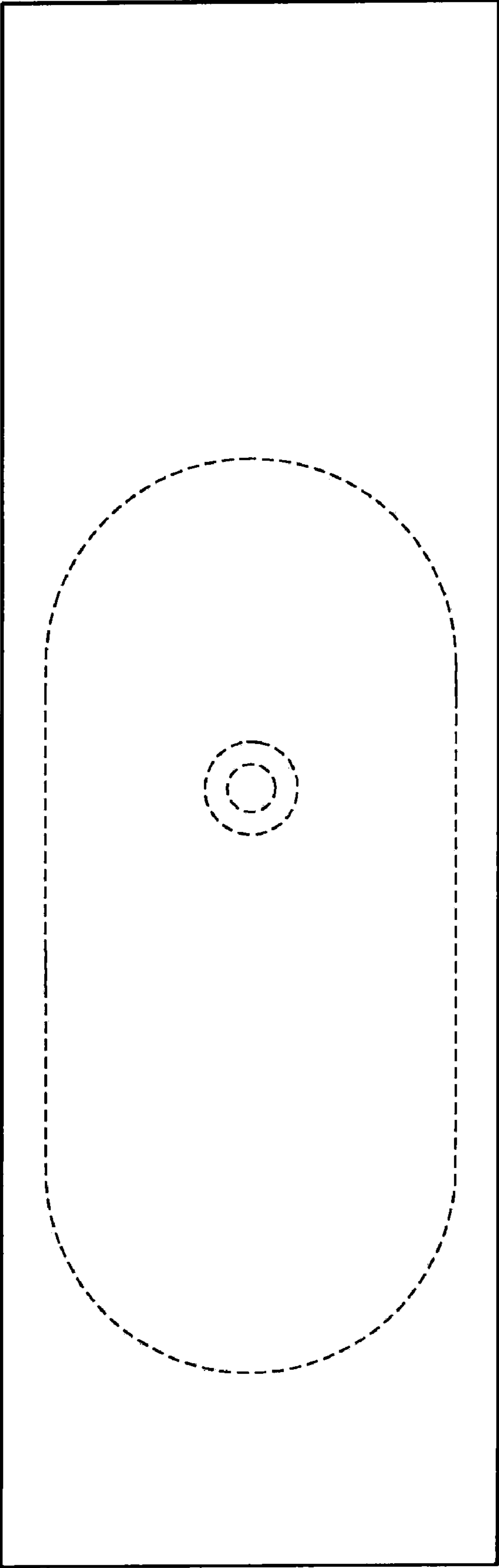

FIG. 13

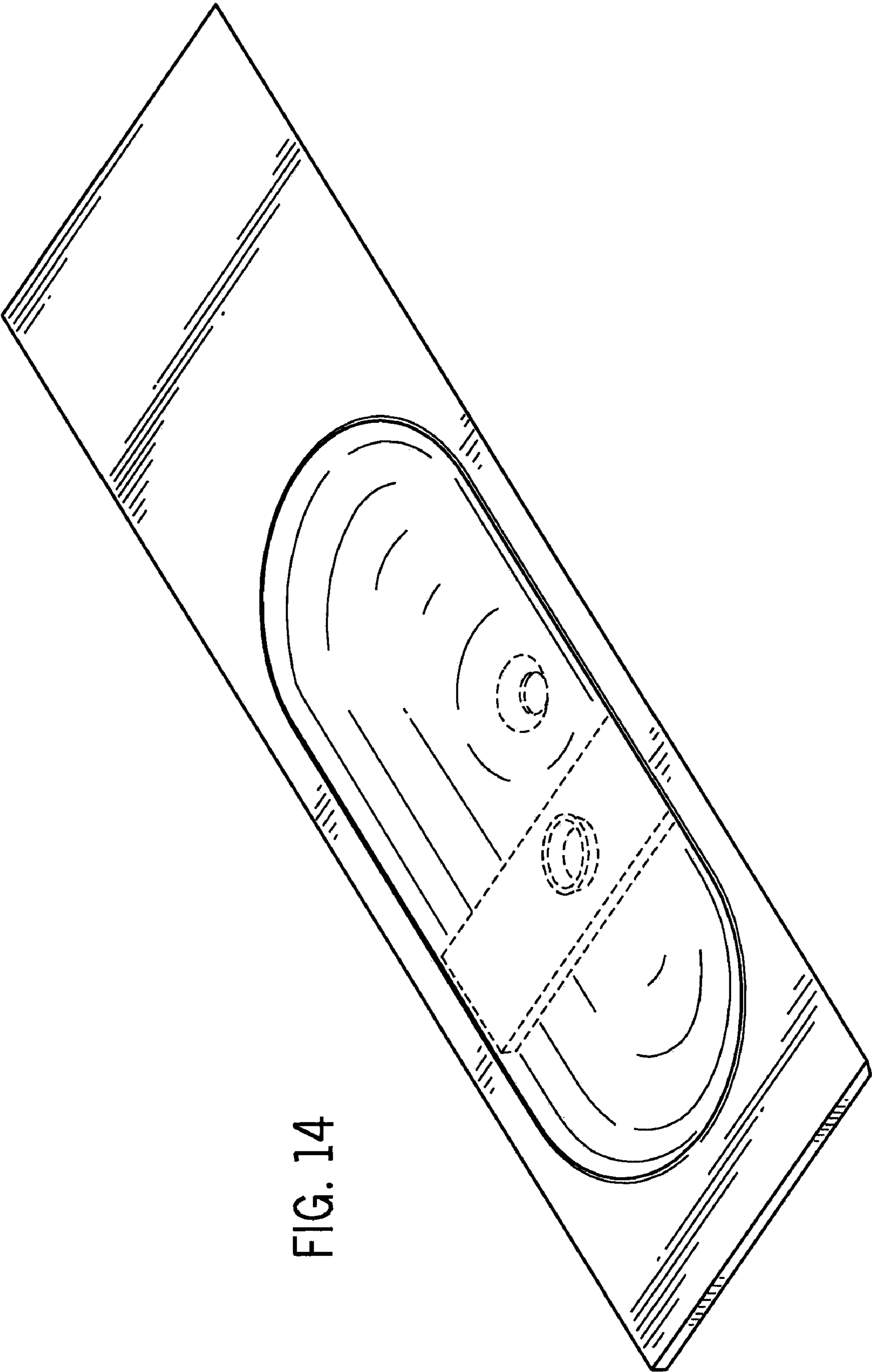

FIG. 14