



US00D624974S

(12) **United States Design Patent**  
**Taylor**

(10) **Patent No.:** **US D624,974 S**  
(45) **Date of Patent:** **\*\* Oct. 5, 2010**

(54) **TOY SNAKE**

(75) Inventor: **Graeme John Taylor**, Wolverhampton  
(GB)

(73) Assignee: **China Industries Limited** (GB)

(\*\*) Term: **14 Years**

(21) Appl. No.: **29/341,120**

(22) Filed: **Jul. 30, 2009**

(30) **Foreign Application Priority Data**

Jan. 30, 2009 (EM) ..... 001079198-0001

(51) **LOC (9) Cl.** ..... **21-01**

(52) **U.S. Cl.** ..... **D21/657; D21/592**

(58) **Field of Classification Search** ..... D11/158;  
D21/576-578, 584-592, 657; 446/72, 97,  
446/268-269, 278-280, 368; D30/160  
See application file for complete search history.

(56) **References Cited**

**U.S. PATENT DOCUMENTS**

857,593	A *	6/1907	Brown	.....	446/368
1,599,947	A *	9/1926	Bishop	.....	446/368
1,745,232	A *	1/1930	Richter	.....	446/368
2,194,537	A *	3/1940	Adams	.....	446/368
2,241,576	A *	5/1941	Barton	.....	446/368
D238,434	S *	1/1976	Berlin	.....	D21/576

5,628,667	A *	5/1997	Levi	.....	446/368
6,461,218	B1 *	10/2002	Mullaney et al.	.....	446/274
7,387,179	B2 *	6/2008	Anhalt et al.	.....	446/278

\* cited by examiner

*Primary Examiner*—Sandra Morris

(74) *Attorney, Agent, or Firm*—Workman Nydegger

(57) **CLAIM**

The ornamental design for a toy snake, as shown and described.

**DESCRIPTION**

FIG. 1 is a top plan view of a toy snake of the present invention, the broken lines illustrating the toy snake in use;

FIG. 2 is left side elevation view of the toy snake shown in FIG. 1, the right side of the toy snake being a mirror image thereof;

FIG. 3 is a bottom plan view of the toy snake shown in FIG. 1;

FIG. 4 is a rear elevation view of the toy snake shown in FIG. 1; and,

FIG. 5 is a front elevation view of the toy snake shown in FIG. 1.

The phantom, broken lines shown in the drawings form part of the design that is not claimed herein.

**1 Claim, 1 Drawing Sheet**

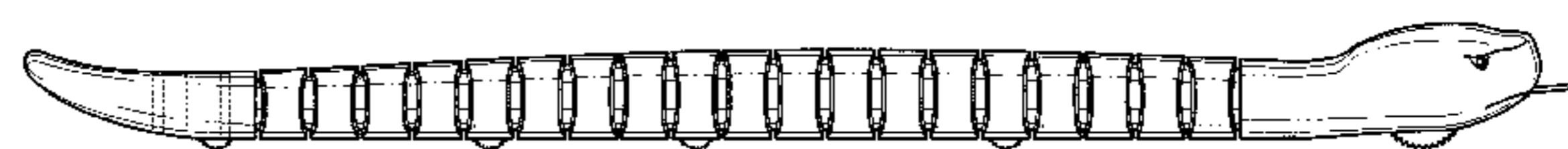
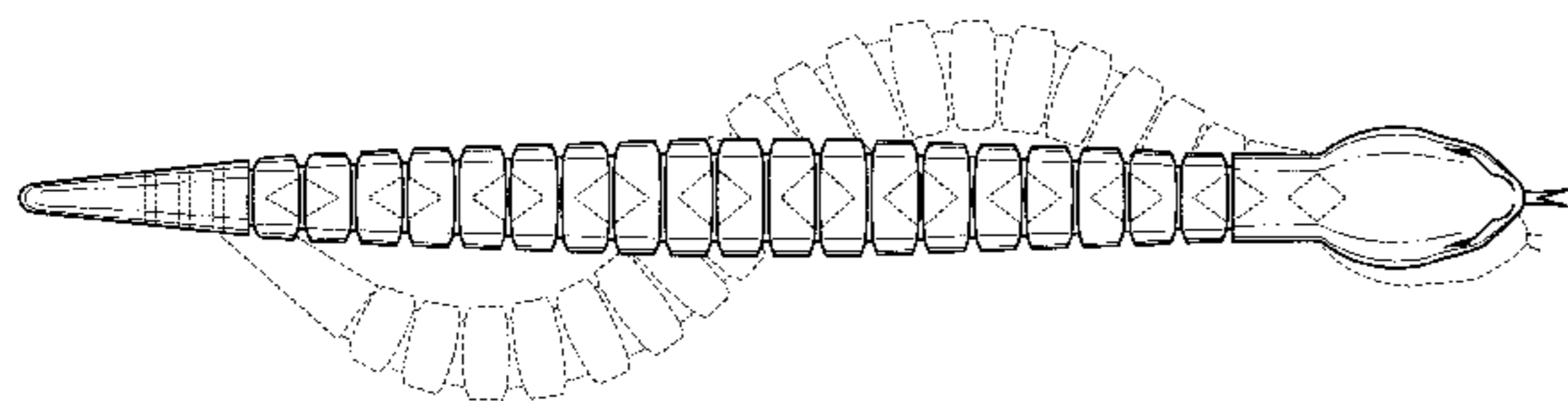

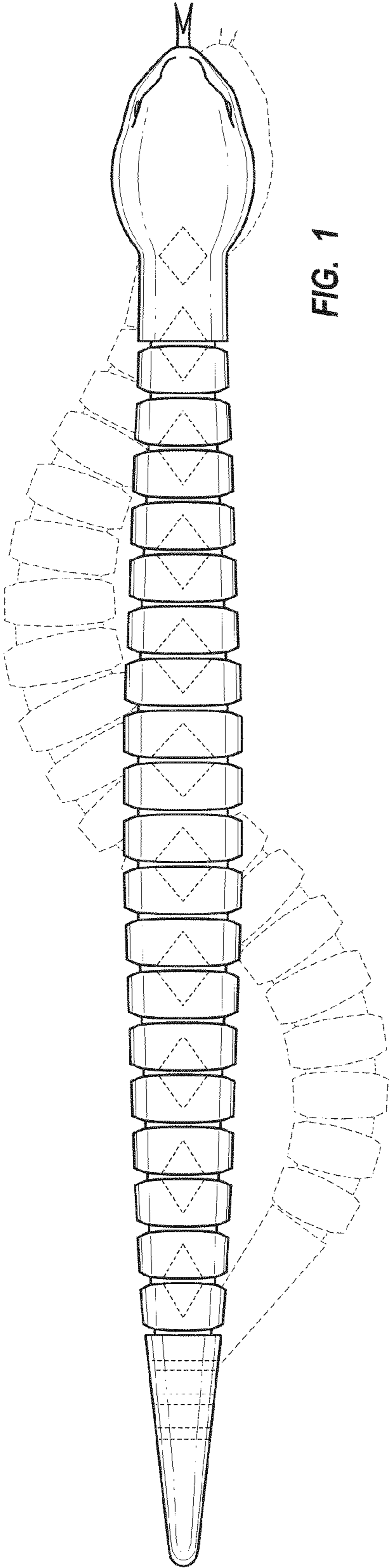

FIG. 1

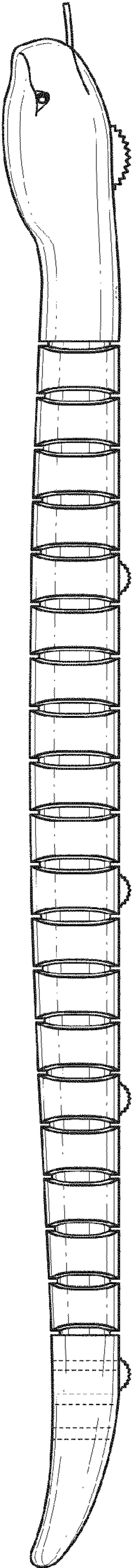

FIG. 2

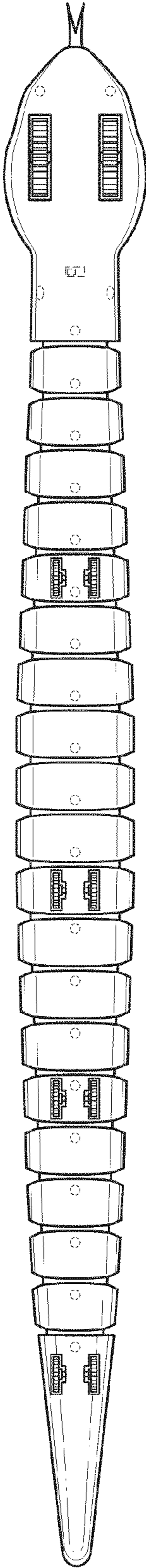

FIG. 3

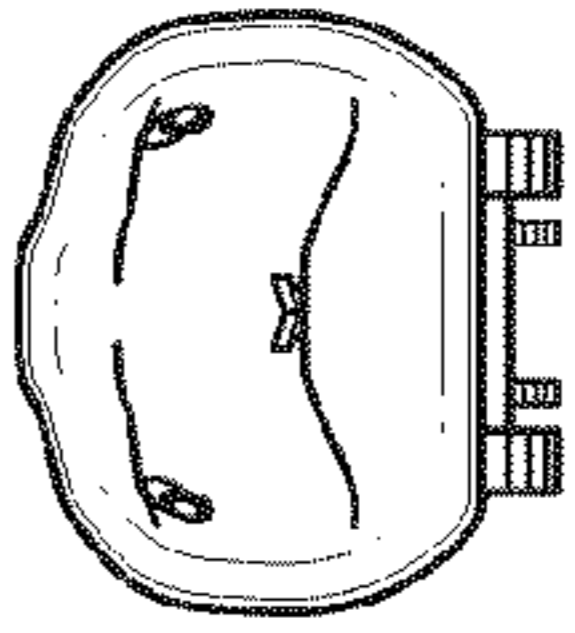

FIG. 4

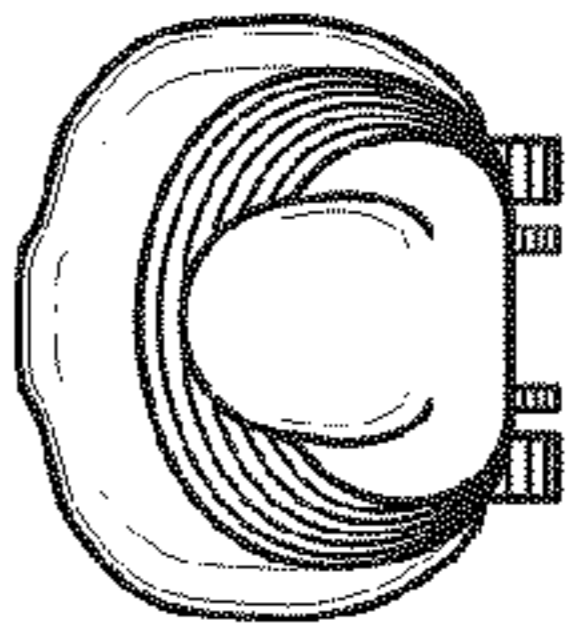

FIG. 5