



US00D624823S

(12) **United States Design Patent**
Brown

(10) **Patent No.:** **US D624,823 S**

(45) **Date of Patent:** **** Oct. 5, 2010**

(54) **BOTTLE**

(75) Inventor: **Edward M. Brown**, Henderson, NV
(US)

(73) Assignee: **Patron Spirits International AG**,
Schaffhausen (CH)

(**) Term: **14 Years**

(21) Appl. No.: **29/352,764**

(22) Filed: **Dec. 24, 2009**

(51) **LOC (9) Cl.** **09-01**

(52) **U.S. Cl.** **D9/544**

(58) **Field of Classification Search** D9/516,
D9/520, 544, 545, 546, 559, 560, 572, 573,
D9/574; 215/381-385

See application file for complete search history.

(56) **References Cited**

U.S. PATENT DOCUMENTS

D10,716 S *	6/1878	Hood	D9/545
D18,221 S *	4/1888	Atwater	D9/544
544,219 A	8/1895	Godet		
D25,207 S *	3/1896	Merriam	D9/500
D29,493 S *	10/1898	Burnett	D9/500
31,126 A	7/1899	Henius		
D31,126 S *	7/1899	Henius	D9/546
640,860 A	1/1900	Baum, Jr.		
D35,558 S *	1/1902	Kiefer	D9/545
37,641 A	11/1905	Hitzl		
824,210 A	6/1906	Sauer		
D44,217 S *	6/1913	Nelson	D9/542
D45,295 S *	2/1914	Haig	D9/542
48,551 A	2/1916	Koken		
D50,341 S *	2/1917	Epstein	D9/544
53,887 A	10/1919	Connor		
58,048 A	5/1921	Svensen		
58,380 A	7/1921	Hothersall		
1,419,509 A	6/1922	Newell		
1,595,040 A	8/1926	Voss		
D88,233 S	11/1932	Koeppen		

D99,363 S	4/1936	Norman		
D99,763 S *	5/1936	Sansby	D9/500
D103,050 S	2/1937	Higgins		
D109,518 S	5/1938	Meier		
D113,045 S	1/1939	Lorenzen		

(Continued)

OTHER PUBLICATIONS

U.S. Trademark Reg. No. 3,318,397 for Getrank Orange & Design in the name of Eckes-Granini Group GmbH, registered Oct. 23, 2007.

(Continued)

Primary Examiner—Stella M Reid

Assistant Examiner—Elizabeth J Oswecki

(74) *Attorney, Agent, or Firm*—Jeffer Mangels Butler & Mitchell LLP

(57) **CLAIM**

The ornamental design for a bottle, as shown and described.

DESCRIPTION

FIG. 1 is a top, perspective view of a bottle showing my new design;

FIG. 2 is a side elevational view thereof, the opposite sides being a mirror image thereof;

FIG. 3 is a top plan view thereof;

FIG. 4 is a bottom plan view thereof;

FIG. 5 is a bottom, perspective view thereof;

FIG. 6 is a cross-sectional view of a bottle taken along line 6—6 in FIG. 3, the opposite side being a mirror image thereof; and,

FIG. 7 is a cross sectional view of a bottle taken along line 7—7 in FIG. 3, the opposite side being a mirror image thereof.

The broken lines and shading shown in the drawing disclosure are for illustrative purposes only and form no part of the claimed design.

1 Claim, 6 Drawing Sheets

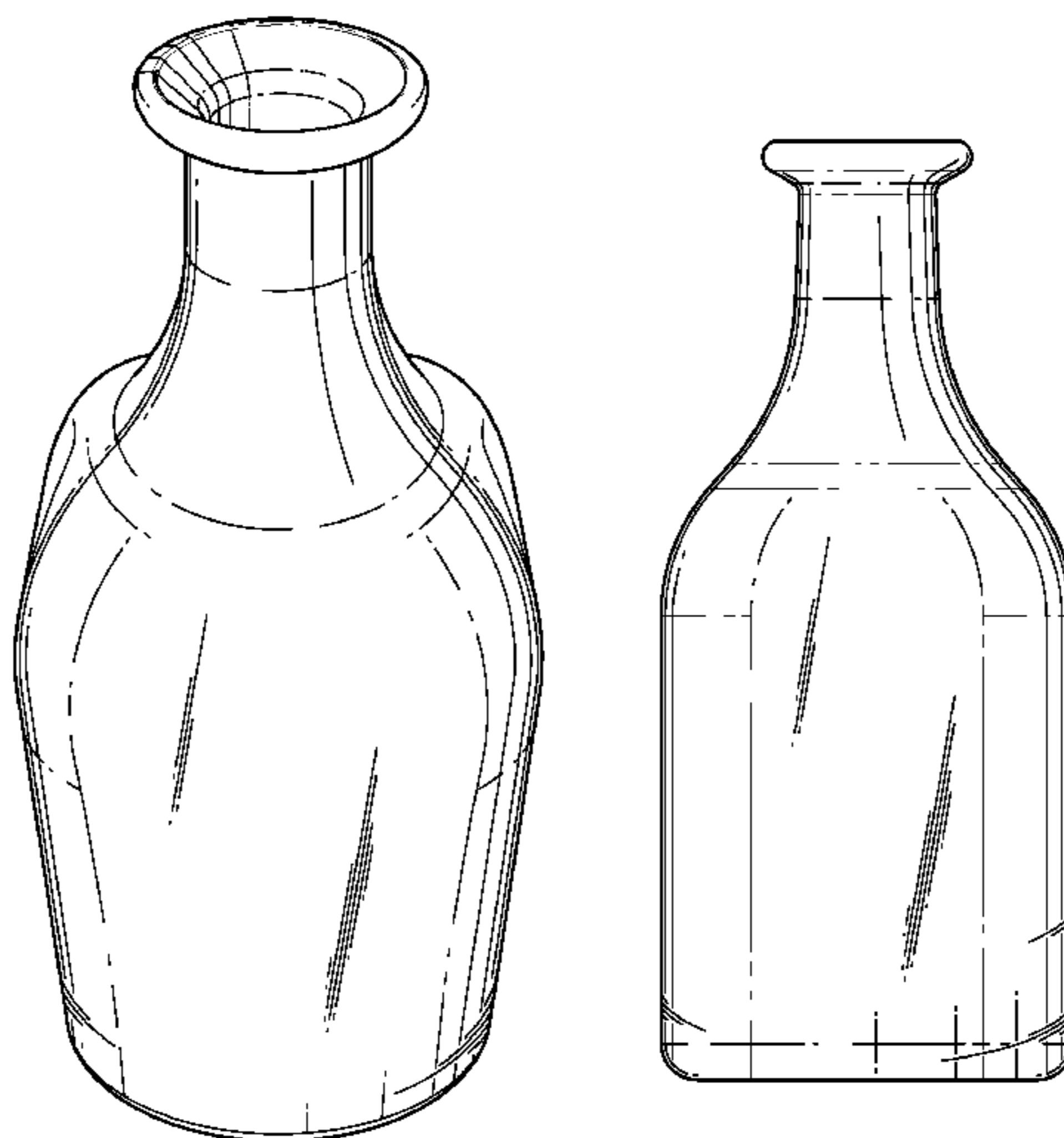

U.S. PATENT DOCUMENTS

D118,500	S	*	1/1940	Lewis	D9/500
D120,425	S	*	5/1940	Neal	D9/500
D142,746	S		10/1945	Stackpole		
D174,591	S		4/1955	Parsell		
D178,808	S	*	9/1956	Roosenuak	D9/500
D198,871	S		8/1964	Akeireb		
D213,824	S		4/1969	Luedtke		
3,460,590	A		8/1969	Robbins		
D227,750	S		7/1973	Goldsholl		
D236,690	S		9/1975	Oliveira et al.		
D242,842	S		12/1976	Wolf		
D255,532	S		6/1980	Saffell		
D268,329	S		3/1983	Cointreau		
D285,776	S		9/1986	Kretz		
D295,145	S		4/1988	Jeanjean		
D300,107	S		3/1989	Trombly		
D331,017	S		11/1992	Chan		
D342,675	S		12/1993	Cazaudehore		
D387,668	S		12/1997	Bond		
D411,460	S		6/1999	Nobuto		
5,944,208	A		8/1999	Gale		
5,971,217	A		10/1999	Visola et al.		
6,308,846	B1		10/2001	Muller		
D458,147	S		6/2002	Sadeghi et al.		
D462,274	S		9/2002	Potts et al.		
D467,180	S		12/2002	Clochot		
D478,818	S		8/2003	Barbagli		
D481,957	S		11/2003	Modjeski		
6,659,300	B2		12/2003	Wurster et al.		
D488,070	S		4/2004	Yourist		
6,935,525	B2		8/2005	Trude		
D537,723	S		3/2007	Wong et al.		
D540,193	S		4/2007	Schimminger		
D544,365	S		6/2007	Werner		
D545,206	S		6/2007	Brown et al.		
D545,683	S		7/2007	Wong et al.		
D548,092	S		8/2007	Klemm		
D548,098	S		8/2007	Lauret		
D548,527	S		8/2007	Rigby et al.		
D550,019	S		9/2007	Lincer		
D554,516	S		11/2007	Rica		
D555,483	S		11/2007	Bezuglov		
D559,113	S		1/2008	Brown et al.		
D561,039	S		2/2008	Del Bon		
D563,233	S		3/2008	Patzak		
D565,421	S		4/2008	De Baschmakoff		
D567,100	S		4/2008	Liden et al.		
D571,223	S		6/2008	Imperato et al.		
D587,586	S		3/2009	Patzak		
D587,589	S		3/2009	Varlet		
D592,519	S		5/2009	Rica		
D595,134	S	*	6/2009	Rica	D9/500
D612,739	S	*	3/2010	Delbon	D9/544
2009/0020498	A1		1/2009	Yourist		

OTHER PUBLICATIONS

U.S. Trademark Reg. No. 3,593,302 for a bottle design in the name of Crayons, Inc., registered Mar. 17, 2009.
 U.S. Trademark Appl. Ser. No. 77/736,572 for a bottle design in the name of Oy Focusin AB, filed May 14, 2009.
 U.S. Trademark Reg. No. 1,028,280 for Grand Marnier Liqueur & Design in the name of Societe des Produits Marnier-Lapostolle, registered Dec. 23, 1975.
 U.S. Trademark Reg. No. 1,546,659 for a bottle design in the name of Societe des Produits Marnier-Lapostolle, registered Jul. 4, 1989.
 U.S. Trademark Reg. No. 2,685,124 for M & Design in the name of Mystic Brands, Inc., registered Feb. 11, 2003.
 U.S. Trademark Reg. No. 2,378,523 for Sobieski & Design in the name of Belvedere, registered Aug. 22, 2000, registered Aug. 22, 2000.

U.S. Trademark Reg. No. 2,513,297 for "T" Handcrafted Using Fresh Botanicals & Design in the name of UDV Amsterdam BV, registered Nov. 27, 2001.
 U.S. Trademark Reg. No. 3,159,907 for Bailey'S the Original Irish Cream R & A Bailey & Design in the name of R & A Bailey & Co., registered Oct. 17, 2006.
 U.S. Trademark Reg. No. 328,869 for Cointreau Liqueur & Design in the name of Cointreau Corporation, registered Oct. 8, 1935.
 U.S. Trademark Appl. Ser. No. 79/013,366 for Colin Scott Est. 1801 in the name of Chivas Holdings (IP) Limited, filed Jun. 11, 2005.
 U.S. Trademark Reg. No. 3,581,867 for E. Cointreau & Design in the name of Cointreau, registered Feb. 24, 2009.
 U.S. Trademark Reg. No. 2,815,475 for G & Design in the name of Gilberts & C.A., S.A., registered Feb. 17, 2004.
 U.S. Trademark Reg. No. 3,094,940 for Hetman & Design in the name of Belvedere, registered May 23, 2006.
 U.S. Trademark Reg. No. 2,970,791 for Jagermeister & Design in the name of Mast-Jagermeister AG, registered Jul. 19, 2005.
 U.S. Trademark Reg. No. 923,586 for Kahlua & Design in the name of the Kahlua Company, registered Nov. 9, 1971.
 U.S. Trademark Appl. Ser. No. 79/069,015 for Oenodb & Design in the name of Oenodb, filed Sep. 12, 2008.
 U.S. Trademark Reg. No. 2,033,429 for Krolewska & Design in the name of Belvedere, registered Jan. 28, 1997.
 U.S. Trademark Reg. No. 3,002,091 for Okno V Europou & Design in the name of Belvedere, registered Sep. 27, 2005.
 U.S. Trademark Reg. No. 3,576,360 for Sobieski Estate & Design in the name of Belvedere, registered Feb. 17, 2009.
 U.S. Trademark Reg. No. 2,751,965 for Captain Morgan & Design in the name of Diageo North America, Inc., registered Aug. 19, 2003.
 U.S. Trademark Reg. No. 2,760,467 for a bottle design in the name of Fratelli Branca-Distillerie S.R.L., registered Sep. 2, 2003.
 U.S. Trademark Appl. Ser. No. 78/676,824 for Campo Azul & Design in the name of Products Finos de Agave S.A. de C.V., filed Jul. 23, 2005.
 U.S. Trademark Reg. No. 2,492,093 for Mandarine Napoleon & Design in the name of Soproma S.A., registered Sep. 25, 2001.
 U.S. Trademark Appl. Ser. No. 77/596,800 for Ron Zacapa Centenario 23 Años Producción Limitada LZ Gold Award 1998 Gold Award 1999 Gold Award 2000 Gold Award 2001 Gran Reserva 23 Años Viejo Y Genuino Ron Mezcla De Ronces Viejos De Las Mieles Virgenes De La Caña De Azúcar Licorera Zacapaneca S.A. Zacapa Guatemala C.A . . . & Design in the name of Rum Creation & Products, Inc., filed Oct. 21, 2008.
 U.S. Trademark Appl. Ser. No. 79/013,352 for The Prince of Whiskies Est. 1801 & Design in the name of Chivas Holdings (IP) Limited, filed Jun. 11, 2005.
 U.S. Trademark Reg. No. 3,507,677 for X-Rated & Design in the name of Skyy Spirits, LLC, registered Sep. 30, 2008.
 U.S. Trademark Reg. No. 2,523,698 for a bottle design in the name of McCormick Distilling Co., Inc., registered Dec. 25, 2001.
 U.S. Trademark Appl. Ser. No. 77/662,032 for a bottle design in the name of Liquidity, Inc., filed Feb. 3, 2009.
 U.S. Trademark Reg. No. 584,459 for B and B Liqueur D O M Le Directeur A.L. Containing Only Benedictine and Brandy & Design in the name of Benedictine Distillerie de La Liqueur de L'Ancienne, registered Jan. 5, 1954.
 U.S. Trademark Appl. Ser. No. 79/024,736 for a bottle design in the name of Avshar Wine Factory LLC, filed Apr. 7, 2006.
 U.S. Trademark Reg. No. 3,274,626 for Chaparritas El Naranjo Chaparritas in the name of Mezgo Inversiones, S.L., registered Aug. 7, 2007.
 U.S. Trademark Reg. No. 3,347,895 for Don Eduardo & Design in the name of BFC Tequila Limited, registered Dec. 4, 2007.
 U.S. Trademark Reg. No. 3,589,661 for Antigua Cruz & Design in the name of Compania Tequilera de Arandas, S. A. de C.V., registered Mar. 17, 2009.
 U.S. Trademark Reg. No. 2,184,022 for a bottle design in the name of Corporacion Licorera 1910 S.A. de C.V., registered Aug. 25, 1998.
 U.S. Trademark Appl. Ser. No. 77/129,779 for a bottle design in the name of Herrera Orendain Elena, filed Mar. 13, 2007.
 U.S. Trademark Reg. No. 1,830,510 for Since 1852 & Design in the name of Canandaigua Wine Company, Inc., registered Apr. 12, 1994.
 U.S. Trademark Appl. Ser. No. 77/698,533 for Chivas Regal Blended Scotch Whiskey Aged 12 Years & Design in the name of Chivas Holdings (IP) Limited, filed Mar. 25, 2009.

U.S. Trademark Reg. No. 2,955,943 for H & Design in the name of Vinomex, S.A. de C.V., registered May 24, 2005.

U.S. Trademark Appl. Ser. No. 79/066,873 for Karlsson'S Gold Vodka Imported in the name of Spirits of Gold AB, filed Feb. 16, 2009.

U.S. Trademark Appl. Ser. No. 77/092,015 for Nemiroff & Design in the name of Nemiroff Intellectual Property Establishment, filed Jan. 26, 2007.

U.S. Trademark Reg. No. 3,325,681 for R A Baileys Minis in the name of R & A Bailey & Co., registered Oct. 30, 2007.

U.S. Trademark Reg. No. 793,119 for a bottle design in the name of Regina Grape Products Co., registered Jul. 20, 1965.

U.S. Trademark Reg. No. 2,319,683 for a bottle design in the name of Tia Maria Limited, registered Feb. 15, 2000.

U.S. Trademark Reg. No. 3,152,316 for a bottle design in the name of Tom Viola and Steven Katz, registered Oct. 3, 2006.

U.S. Trademark Appl. Ser. No. 77/005,188 for a bottle design in the name of Luis Torres Bolanos, filed Sep. 22, 2006.

U.S. Trademark Reg. No. 3,529,524 for a bottle design in the name of Casa Noble Spirits, LLC, registered Nov. 4, 2008.

U.S. Trademark Reg. No. 3,066,910 for a bottle design in the name of Constellation Spirits Inc., registered Mar. 7, 2006.

U.S. Trademark Appl. Ser. No. 78/511,505 for a bottle design in the name of Grupo Tequilero Mexico SA de CV, filed Nov. 4, 2004.

U.S. Trademark Reg. No. 3,482,325 for a bottle design in the name of Bacardi & Company Limited, registered Aug. 5, 2008.

CTM Design Reg. No. 000924717-0002 for a bottle design in the name of Fonte Sole S.r.l., registered Apr. 11, 2008.

U.S. Trademark Reg. No. 3,381,806 for a bottle design in the name of Heavy Water International A/S, registered Feb. 12, 2008.

U.S. Trademark Reg. No. 3,726,257 for Oxley & Design in the name of Bacardi & Company Limited, registered Dec. 15, 2009.

U.S. Trademark Reg. No. 2,550,236 for a design in the name of V&S Vine & Sprit Aktiebolag (Publ), registered Mar. 19, 2002.

U.S. Trademark Reg. No. 1,122,519 for a bottle design in the name of Koninklijke Grolsch N.V., registered Jul. 17, 1979.

U.S. Trademark Reg. No. 2,169,823 for a bottle design in the name of Anheuser-Busch, Incorporated, registered Jun. 30, 1998.

U.S. Appl. No. 78/940,080 for Gordon'S & Design in the name of Diageo Brands B.V., filed Jul. 28, 2006.

U.S. Trademark Reg. No. 3,109,598 for Palace Vodka & Design in the name of Przedsiębiorstwo Polmos Bialystok S.A., registered Jun. 27, 2006.

U.S. Trademark Appl. Ser. No. 77/764,542 for Sin Thirst Sin Premium French Wine & Design in the name of Florent Carmin, filed Jun. 20, 2009.

U.S. Trademark Reg. No. 3,365,849 for T Tanqueray Rangpur & Design in the name of Diageo Brands B.V., registered Jan. 8, 2008.

U.S. Trademark Reg. No. 2,415,247 for Woodford Reserve Labrot & Graham Distiller'S Select & Design in the name of Brown-Forman Corporation, registered Dec. 26, 2000.

U.S. Trademark Reg. No. 3,408,123 for a bottle design in the name of V&S Vin & Sprit Aktiebolag (Publ), registered Apr. 8, 2008.

U.S. Trademark Reg. No. 3,597,589 for a bottle design in the name of Debowa Polska Spolka Jawna Jerzy Markiewicz - Leszek Markiewicz, registered Mar. 31, 2009.

U.S. Trademark Reg. No. 2,914,718 for a bottle design in the name of Dean Intellectual Property Services, Inc., registered Dec. 28, 2004.

U.S. Trademark Reg. No. 2,730,961 for a bottle design in the name of Beverage Marketing USA, Inc., registered Jul. 1, 2003.

U.S. Trademark Reg. No. 3,469,572 for a bottle design in the name of The Coca-Cola Company, registered Jul. 15, 2008.

U.S. Trademark Reg. No. 3,580,600 for O'Grae Sok Iz Granata 100% Sok Priamogo O'tzhima & Design in the name of Obschestvo S Ogranichennoy; Otvetstvennostyo; "O'gre", registered Feb. 24, 2009.

U.S. Trademark Reg. No. 1,000,420 for a bottle design in the name of Sunny Delight Beverages Co., registered Dec. 24, 1974.

U.S. Trademark Reg. No. 2,865,796 for a bottle design in the name of Royal Wine Corporation, registered Jul. 20, 2004.

U.S. Trademark Reg. No. 2,945,840 for a bottle design in the name of S. Martinelli & Company, registered May 3, 2005.

U.S. Trademark Reg. No. 2,945,841 for a bottle design in the name of S. Martinelli & Company, registered May 3, 2005.

U.S. Trademark Reg. No. 3,007,198 for Patron XO Cafe Coffee Liqueur Made With Tequila & Design in the name of Patron Spirits International AG, registered Oct. 18, 2005.

U.S. Trademark Reg. No. 2,508,062 for Savanna Dry Premium Cider & Design in the name of Stellenbosch Farmers' Winery Limited, registered Nov. 13, 2001.

U.S. Trademark Reg. No. 1,693,459 for a bottle design in the name of Patron Spirits International AG, registered Jun. 9, 1992.

U.S. Trademark Reg. No. 2,147,067 for a bottle design in the name of Patron Spirits International AG, registered Mar. 31, 1998.

U.S. Trademark Reg. No. 3,629,078 for a bottle design in the name of Tequilas Rancho Viejo SA de CV, registered May 26, 2009.

U.S. Trademark Reg. No. 3,713,485 for Citronge & Design in the name of Patron Spirits International AG, registered Nov. 17, 2009.

CTM Trademark Reg. No. 001509215 for Ruinart & Design in the name of Champagne Ruinart, registered May 7, 2001.

CTM Trademark Reg. No. 002261824 for a bottle design in the name of Ultimat Spirits GmbH, registered Jul. 9, 2002.

CTM Trademark Appl. Ser. No. 004414876 for a bottle design in the name of The Coca-Cola Company, filed Apr. 29, 2005.

UK/GB Trademark Appl. Ser. No. 2391516 for a bottle design in the name of The Coca-Cola Company, filed May 6, 2005.

CTM Design Reg. No. 000044854-0002 for a bottle design in the name of Vetro Special Commerciale Italia Srl, registered Jun. 26, 2003.

CTM Design Reg. No. 000119565-0002 for a bottle design in the name of Valery Glass S.R.L., registered Dec. 19, 2003.

CTM Design Reg. No. 000119565-0003 for a bottle design in the name of Valery Glass S.R.L., registered Dec. 19, 2003.

CTM Design Reg. No. 000211487-0003 for a bottle design in the name of Valery Glass S.R.L., registered Aug. 6, 2004.

CTM Design Reg. No. 000358767-0001 for a bottle design in the name of Binderer St. Ursula Weinkellerei GmbH, registered Jun. 22, 2005.

CTM Design Reg. No. 000907076-0001 for a bottle design in the name of Save S.R.L., registered Apr. 1, 2008.

CTM Design Reg. No. 001028625-0008 for a bottle design in the name of Saverglass, societe anonyme, registered Oct. 27, 2008.

CTM Design Reg. No. 00108864-0001 for a bottle design in the name of Save S.R.L., registered Mar. 19, 2009.

CTM Design Reg. No. 001145270-0001 for a bottle design in the name of Waterconcept AB, registered Jun. 11, 2009.

CTM Design Reg. No. 001145270-0002 for a bottle design in the name of Waterconcept AB, registered Jun. 11, 2009.

CTM Design Reg. No. 001145270-0003 for a bottle design in the name of Waterconcept AB, registered Jun. 11, 2009.

CTM Design Reg. No. 001145270-0004 for a bottle design in the name of Waterconcept AB, registered Jun. 11, 2009.

CTM Design Reg. No. 000009782-0002 for a bottle design in the name of Vetro Special Commerciale Italia Srl, registered Apr. 1, 2003.

CTM Design Reg. No. 000009782-0003 for a bottle design in the name of Vetro Special Commerciale Italia Srl, registered Apr. 1, 2003.

CTM Design Reg. No. 000350038-0001 for a bottle design in the name of Abbott Laboratories, registered Jun. 6, 2005.

CTM Design Reg. No. 000350038-0002 for a bottle design in the name of Abbott Laboratories, registered Jun. 6, 2005.

CTM Design Reg. No. 000372172-0005 for a bottle design in the name of Bruni Glass Spa, registered Jul. 13, 2005.

CTM Design Reg. No. 000711957-0001 for a bottle design in the name of Sovena - Comercio e Industria de Produtos Alimentares, S.A., registered Apr. 23, 2007.

CTM Design Reg. No. 000918230-0001 for a bottle design in the name of Sidel Participations, Societe par actions simplifiee, registered Apr. 16, 2008.

CTM Design Reg. No. 000924717-0001 for a bottle design in the name of Fonte Sole S.r.l., registered Apr. 11, 2008.

* cited by examiner

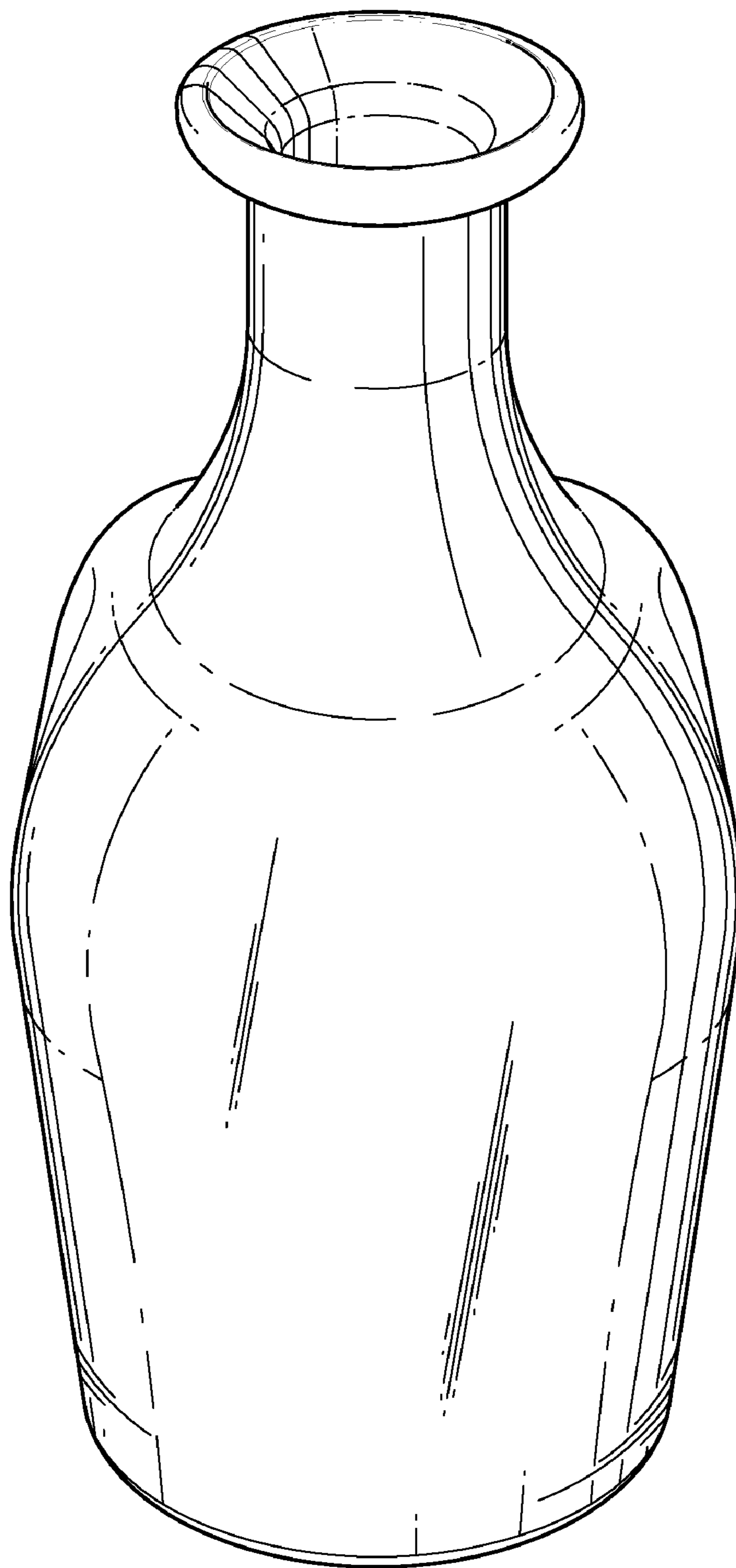

FIG. 1

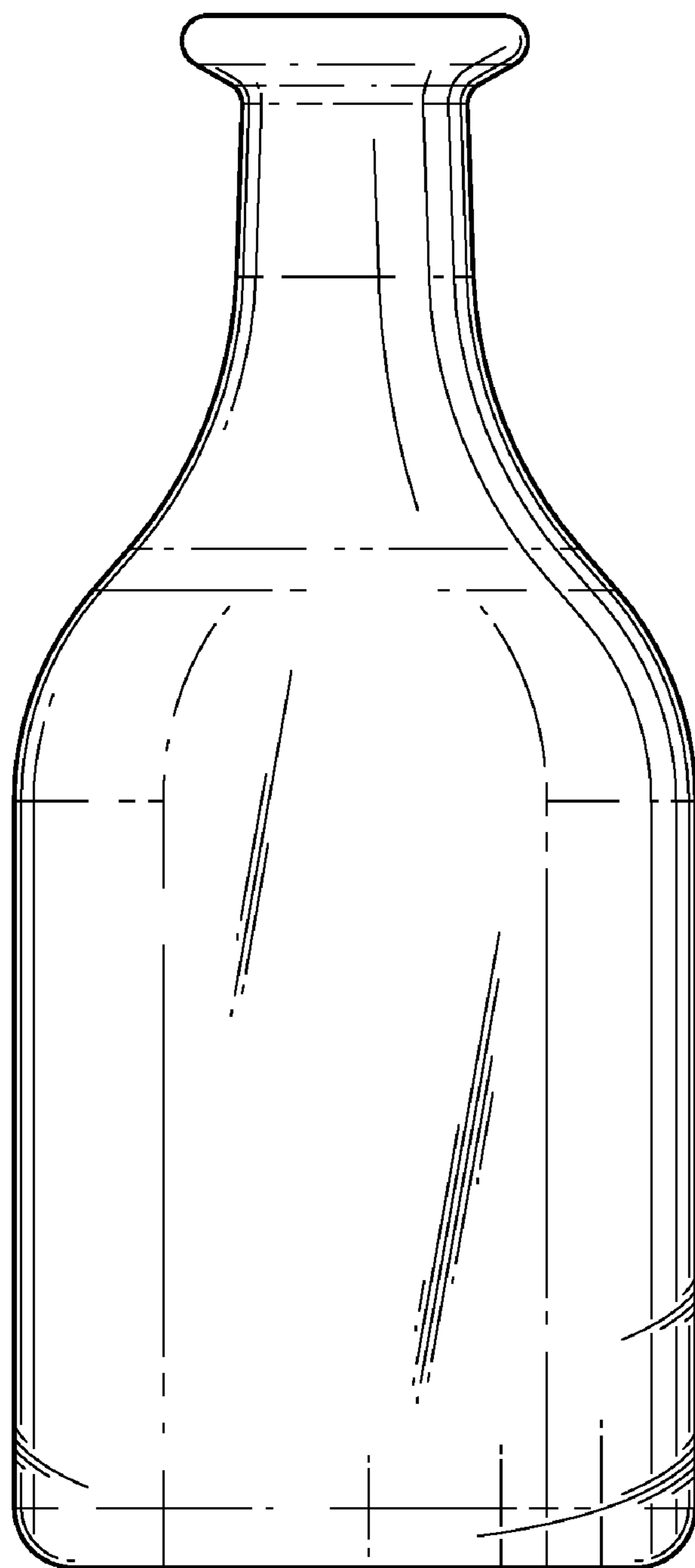

FIG. 2

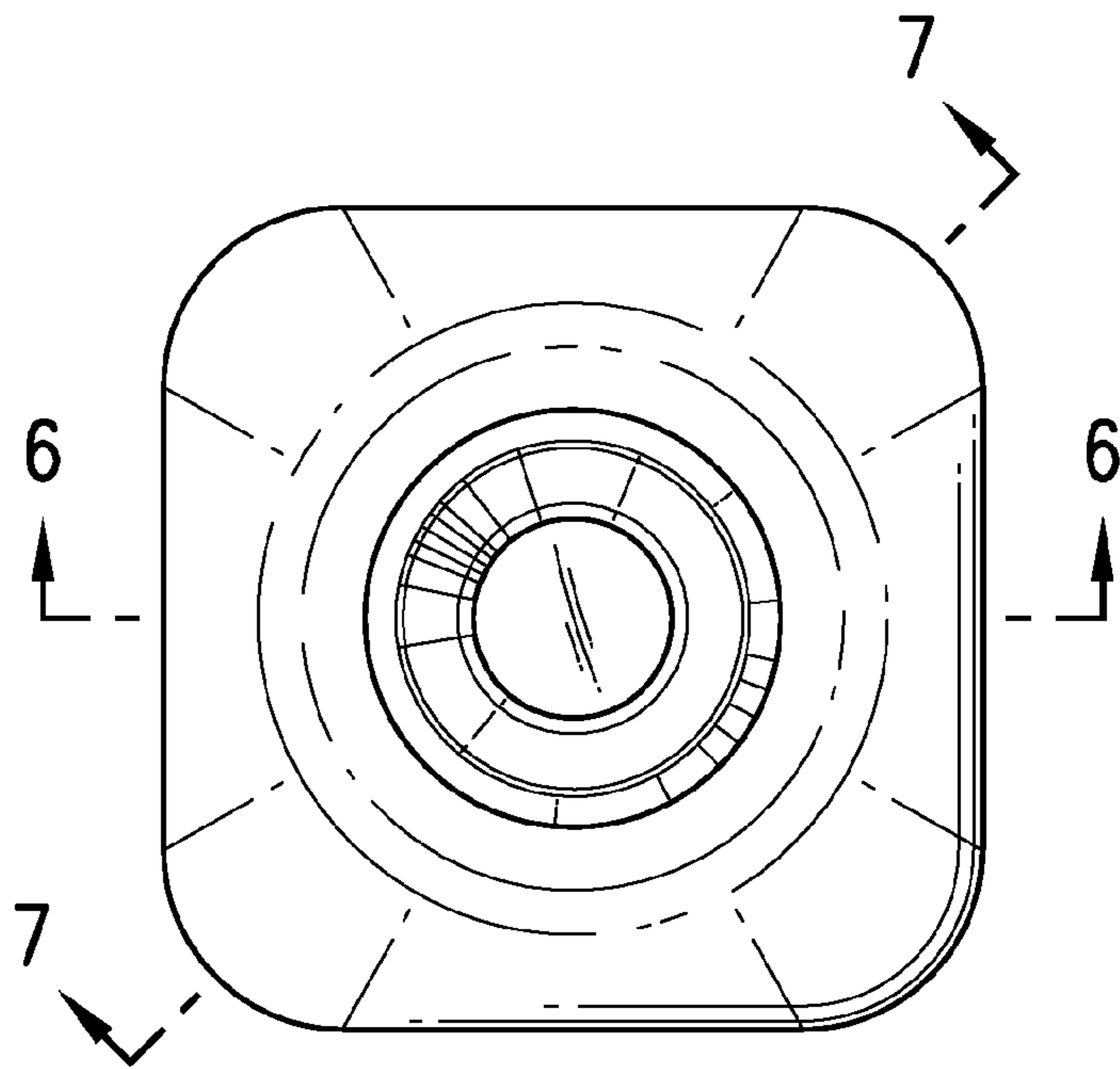

FIG. 3

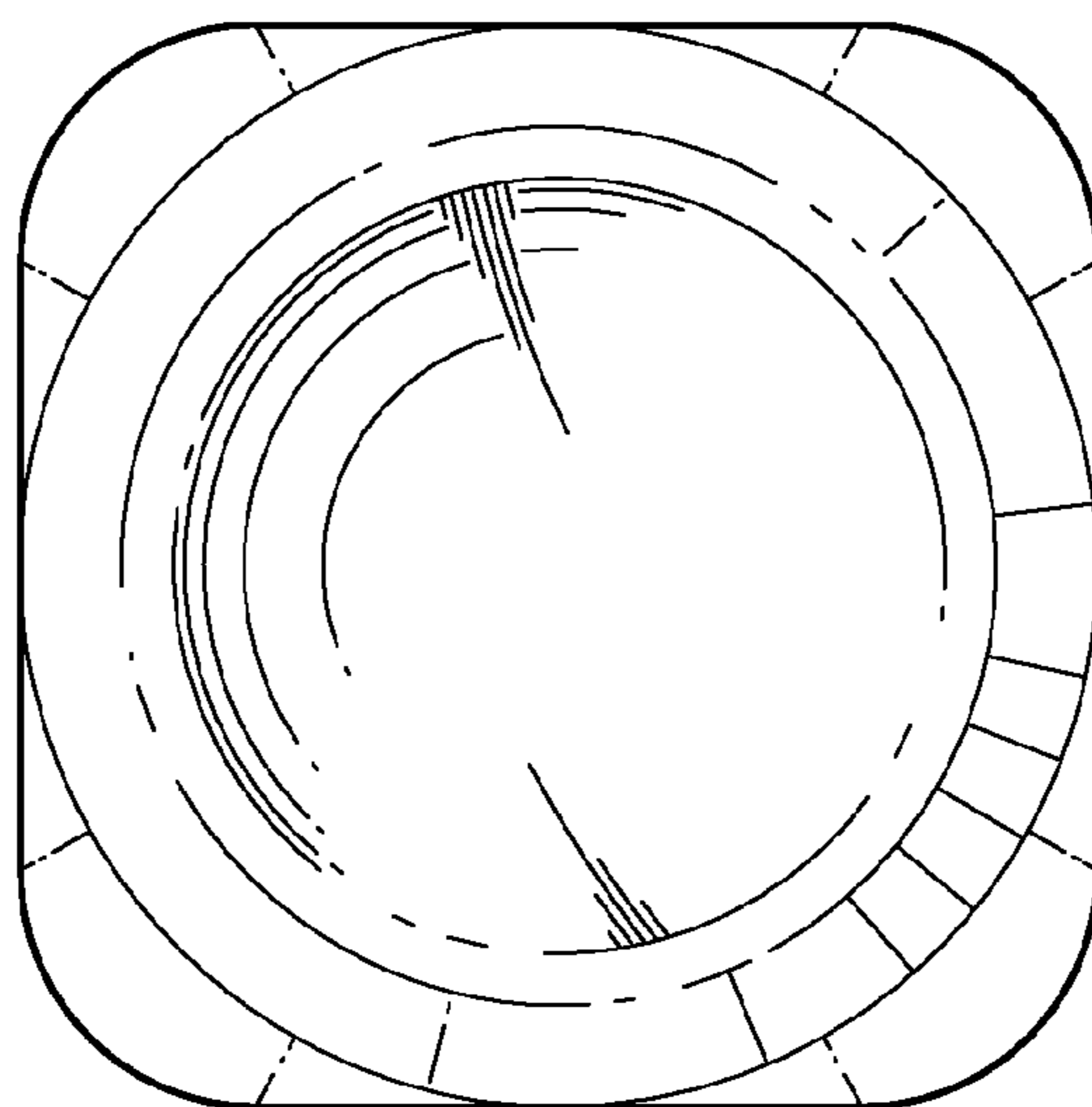

FIG. 4

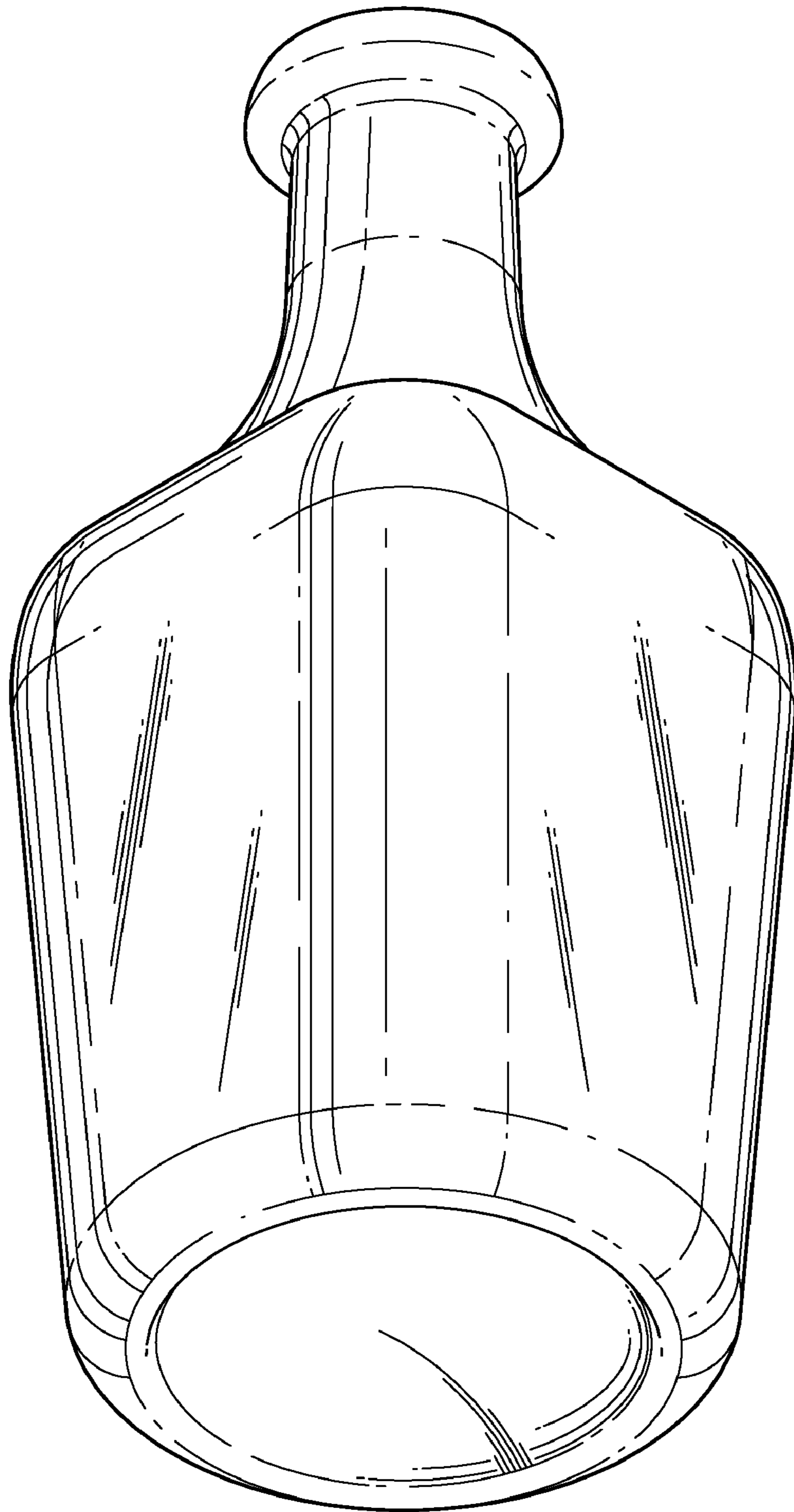

FIG. 5

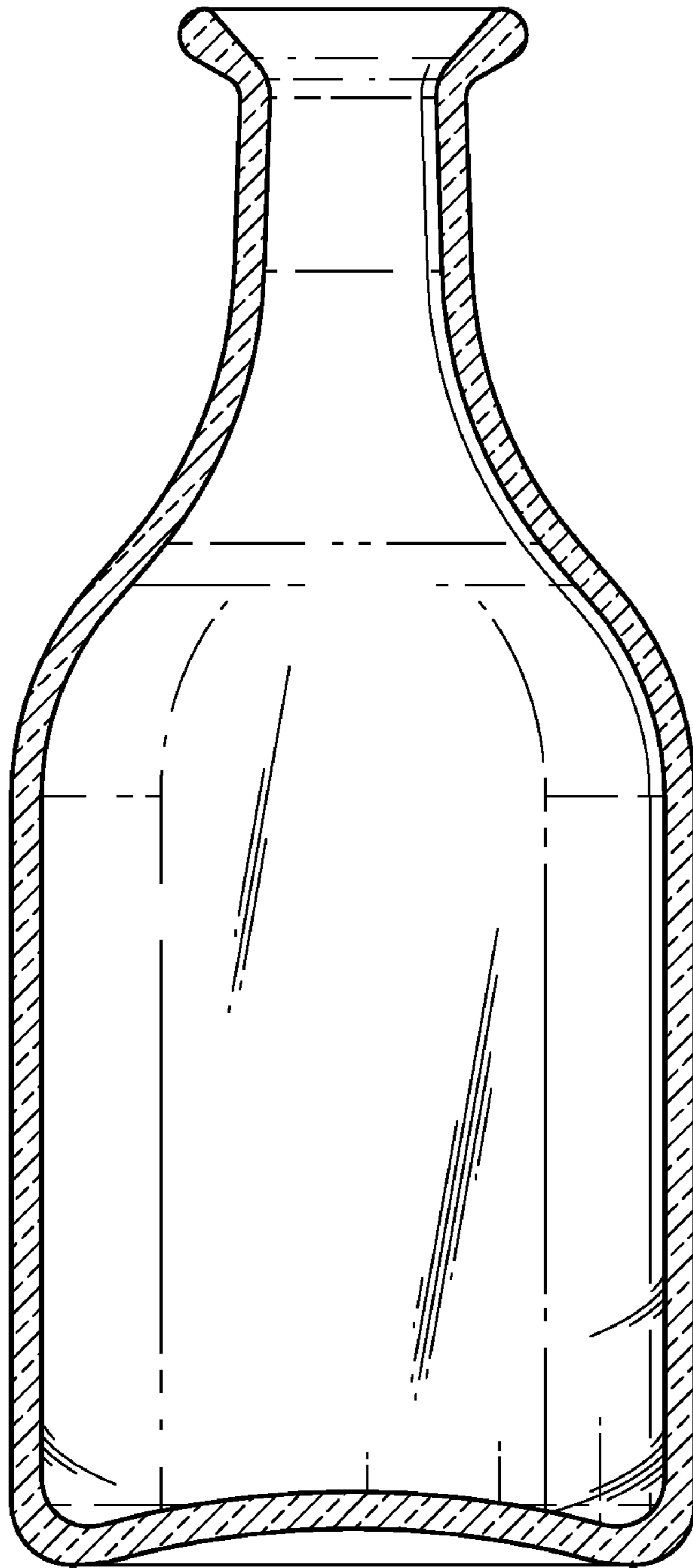

FIG. 6

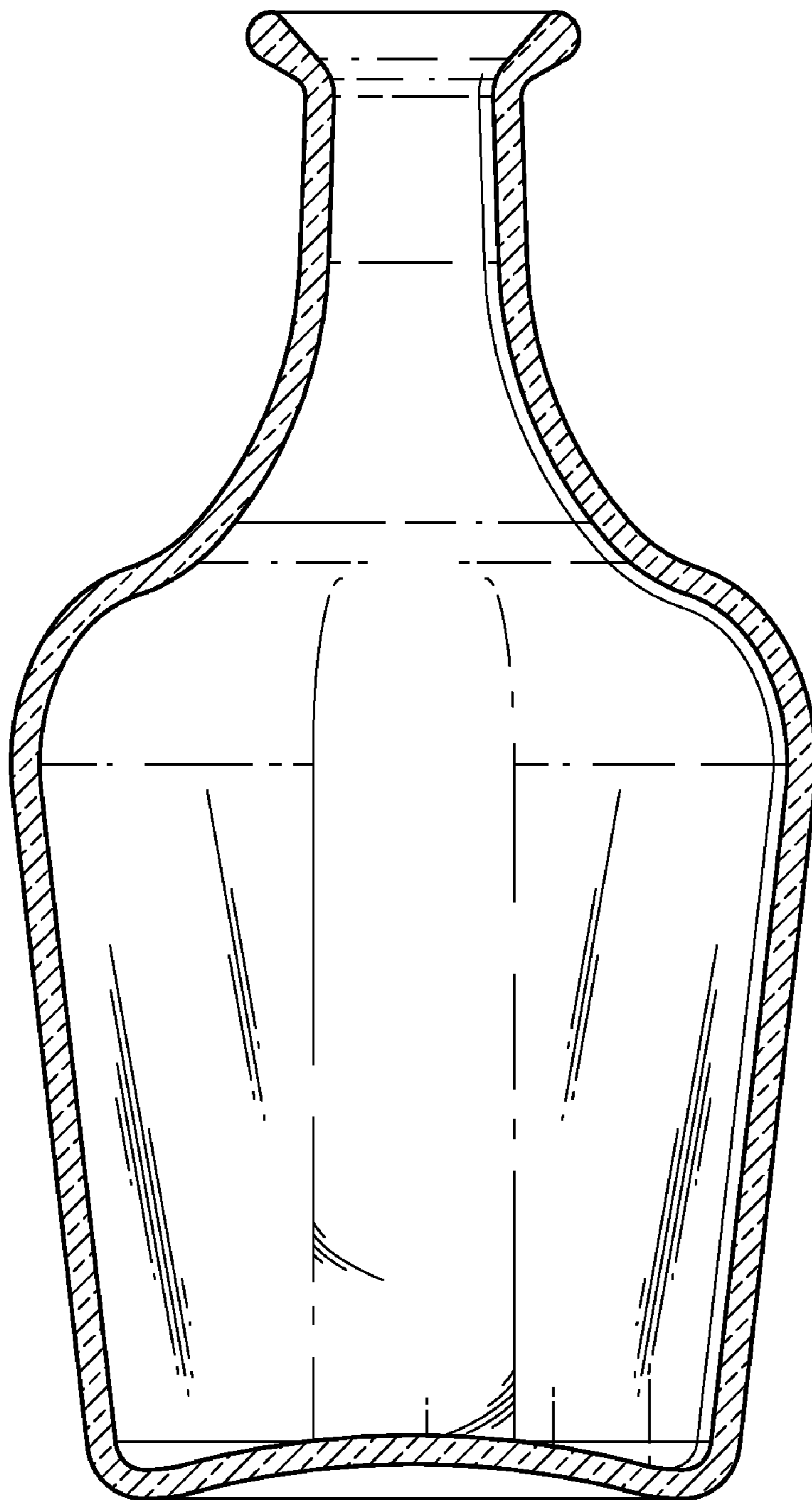

FIG. 7