



US00D624821S

(12) **United States Design Patent**
Leonardis

(10) **Patent No.:** **US D624,821 S**

(45) **Date of Patent:** **** Oct. 5, 2010**

(54) **BOTTLE**

(76) **Inventor:** **Sam John Leonardis**, 99-52 66th Rd.,
Apt. 5AA, Rego Park, NY (US) 11374

(**) **Term:** **14 Years**

(21) **Appl. No.:** **29/341,004**

(22) **Filed:** **Jul. 29, 2009**

(51) **LOC (9) Cl.** **09-01**

(52) **U.S. Cl.** **D9/503**; D9/449; D9/454

(58) **Field of Classification Search** D9/435,
D9/443, 447, 449, 452-454, 500, 502-505,
D9/516, 549, 557-558, 682, 686, 688, 690,
D9/692; D7/509-511, 601-602, 605, 608,
D7/629; 215/11.1, 200, 235-236, 270, 301,
215/305-306, 316, 379, 381-382; 220/200,
220/288, 290, 660, 662, 665, 669-673, 675,
220/677, 680, 810; 222/544, 548, 556, 562
See application file for complete search history.

(56) **References Cited**

U.S. PATENT DOCUMENTS

D239,922 S * 5/1976 Utley D9/500
D276,889 S * 12/1984 Biesecker D9/500
D287,211 S * 12/1986 Weiss D7/608

D291,537 S * 8/1987 Crawford et al. D9/440
5,022,566 A * 6/1991 Song et al. 222/480
D320,939 S * 10/1991 Hofmann et al. D9/447
D408,288 S * 4/1999 Wilson et al. D9/531
D433,336 S * 11/2000 Weber D9/538
D605,515 S * 12/2009 Leonardis D9/449

* cited by examiner

Primary Examiner—Ian Simmons

Assistant Examiner—Dana L Sipos

(74) *Attorney, Agent, or Firm*—Stephen F. Rost

(57) **CLAIM**

The ornamental design for a bottle, as shown and described.

DESCRIPTION

FIG. 1 is a top perspective view of a bottle showing my new design;

FIG. 2 is a front elevation view thereof;

FIG. 3 is a top plan view thereof, shown at an enlarged scale;

FIG. 4 is a left side elevation view of FIG. 2;

FIG. 5 is a rear elevation view thereof; and,

FIG. 6 is a bottom plan view there.

1 Claim, 3 Drawing Sheets

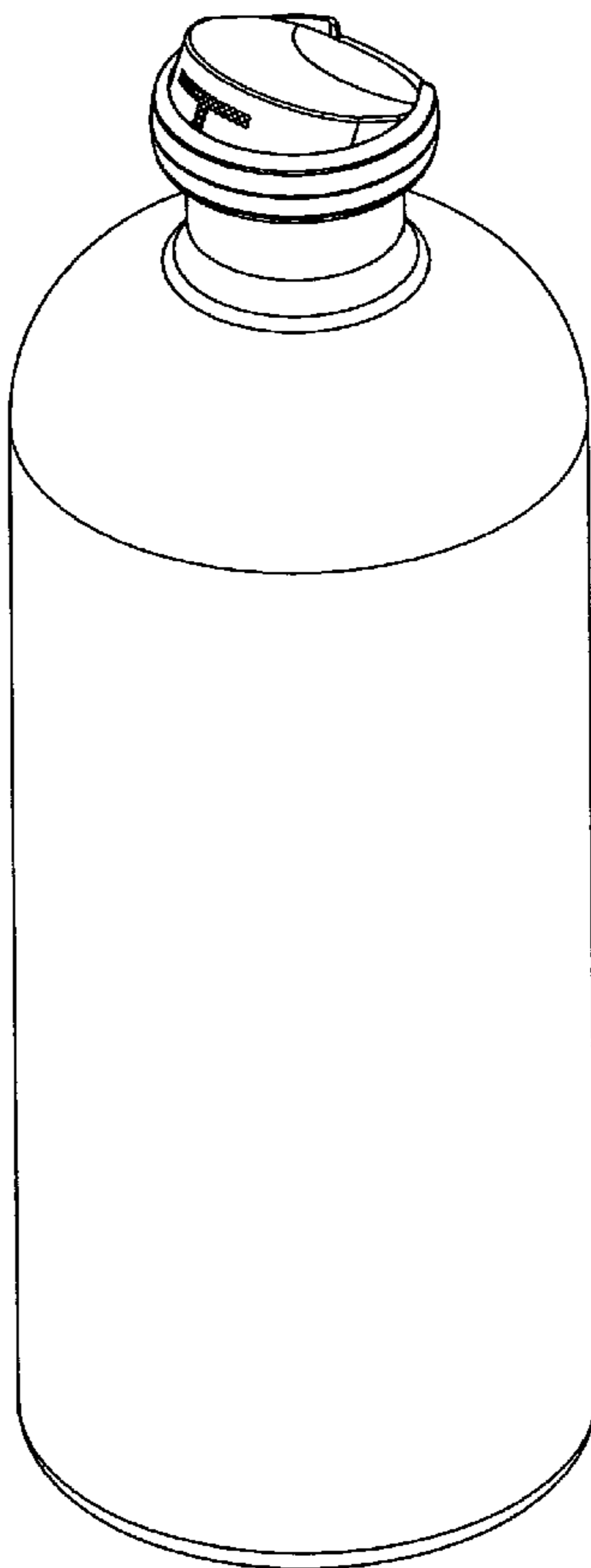

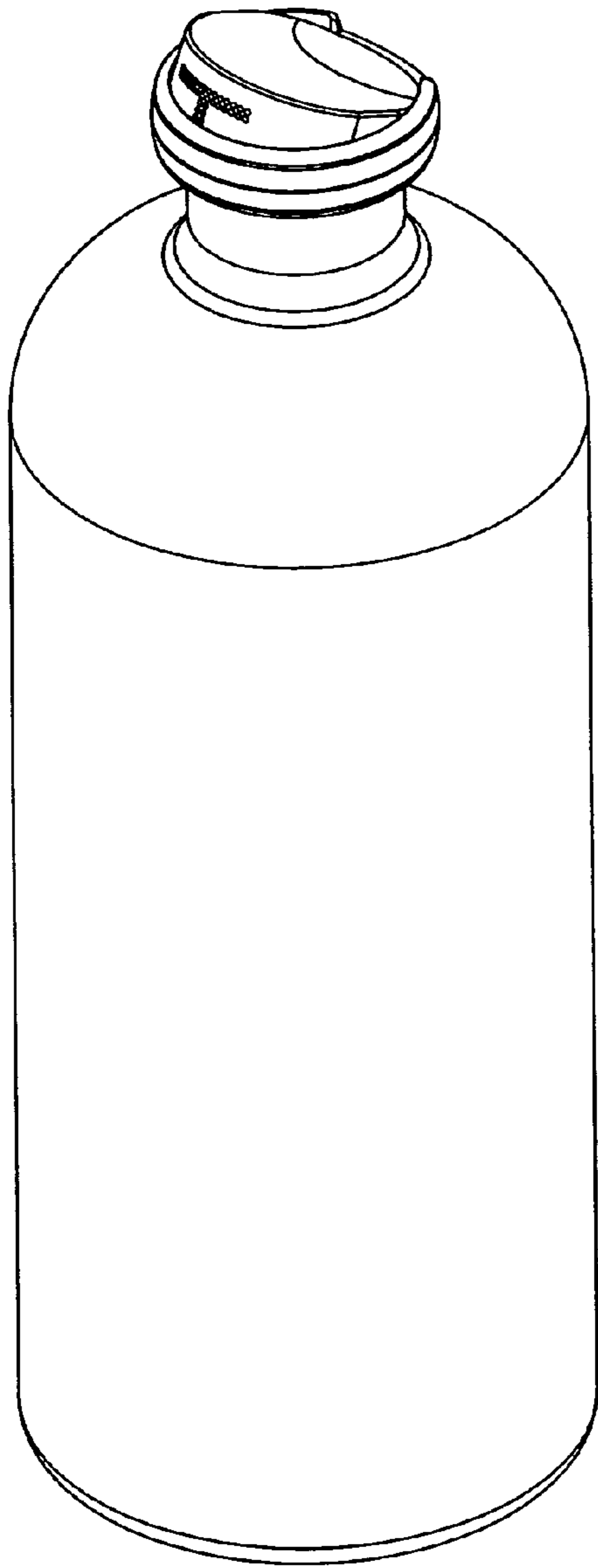

FIG. 1

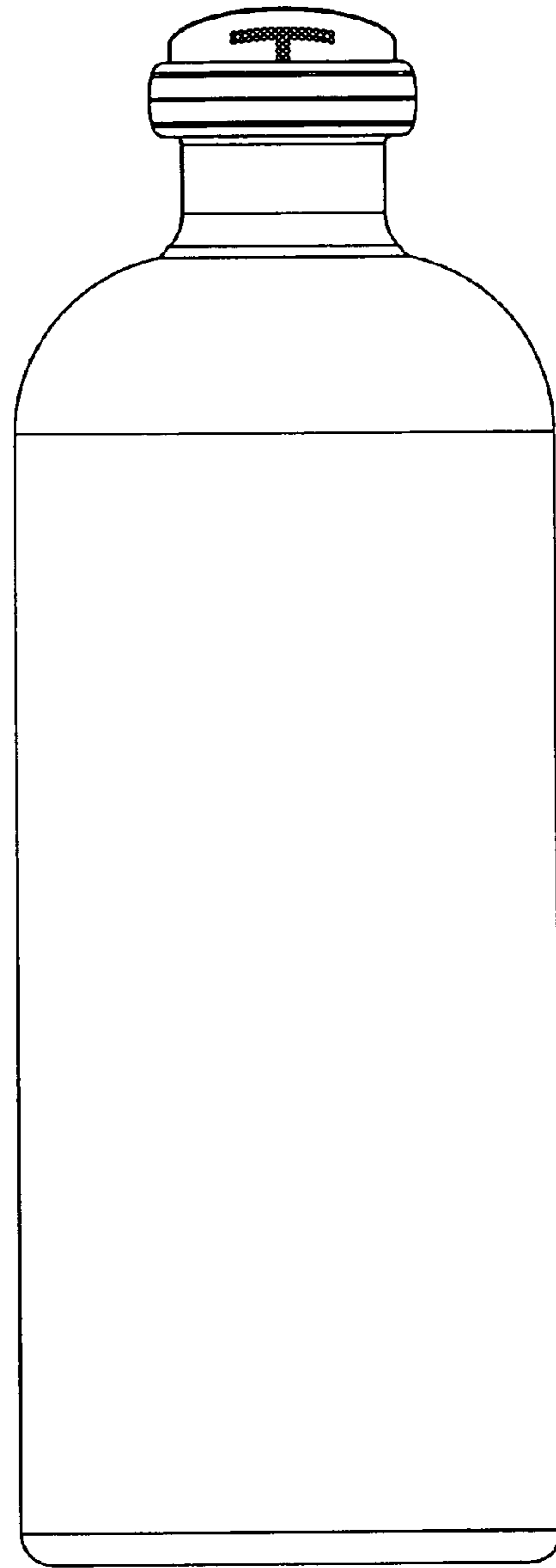

FIG. 2

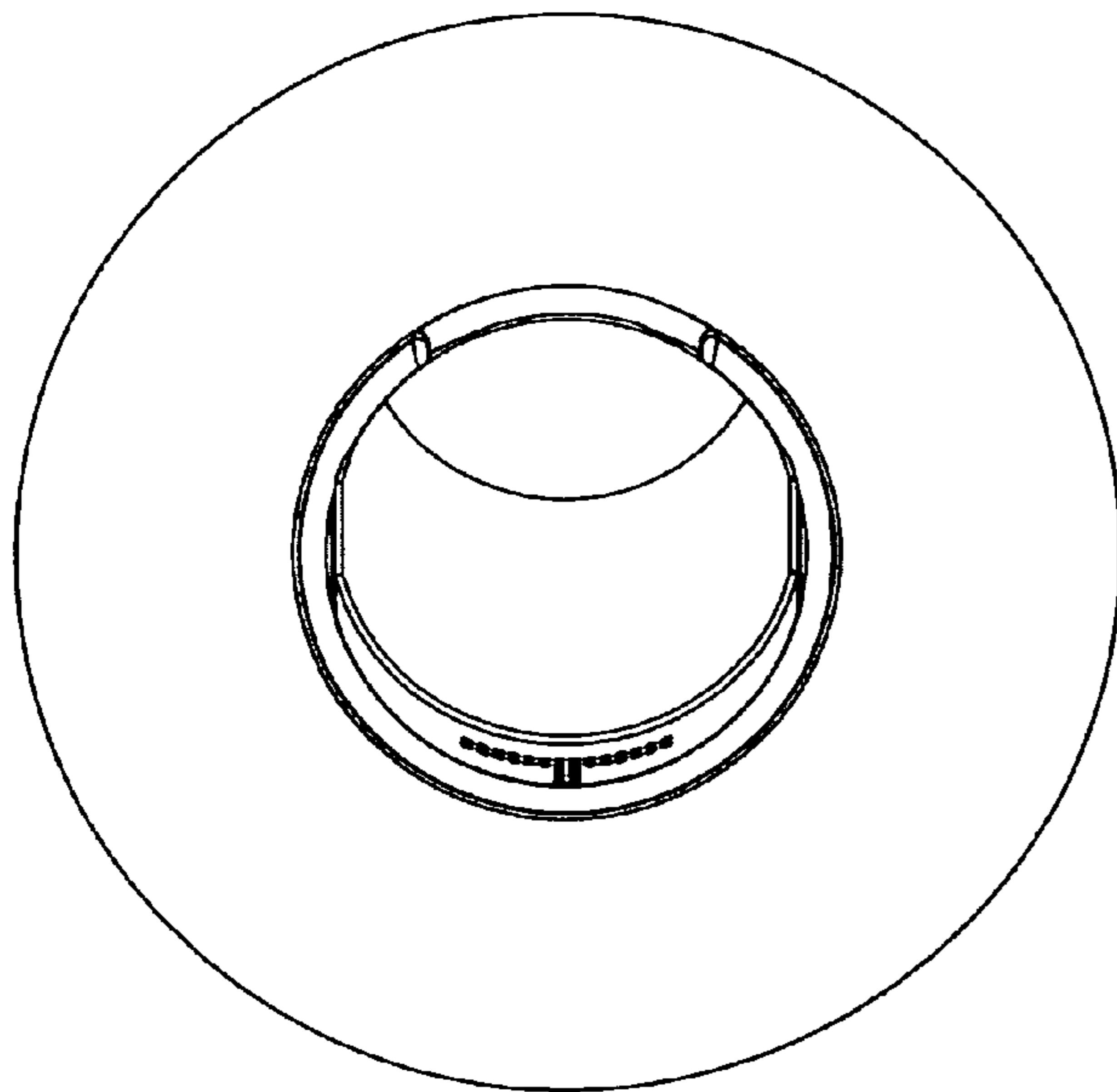

FIG.3

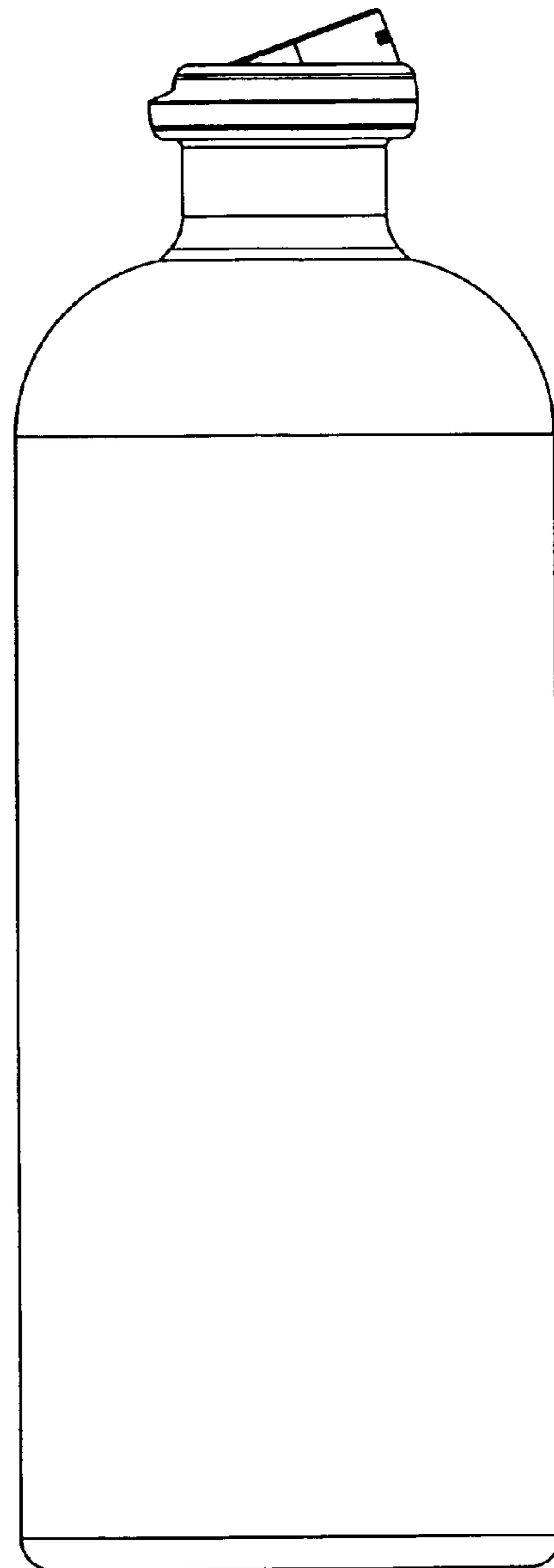

FIG.4

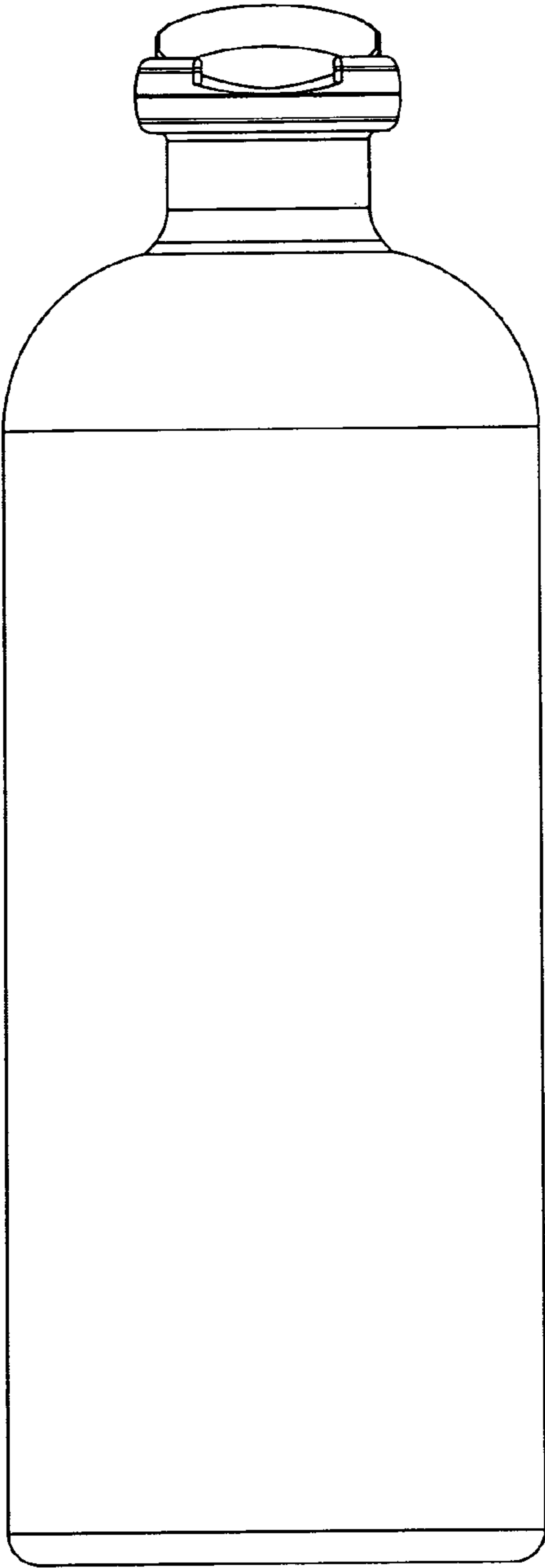

FIG.5

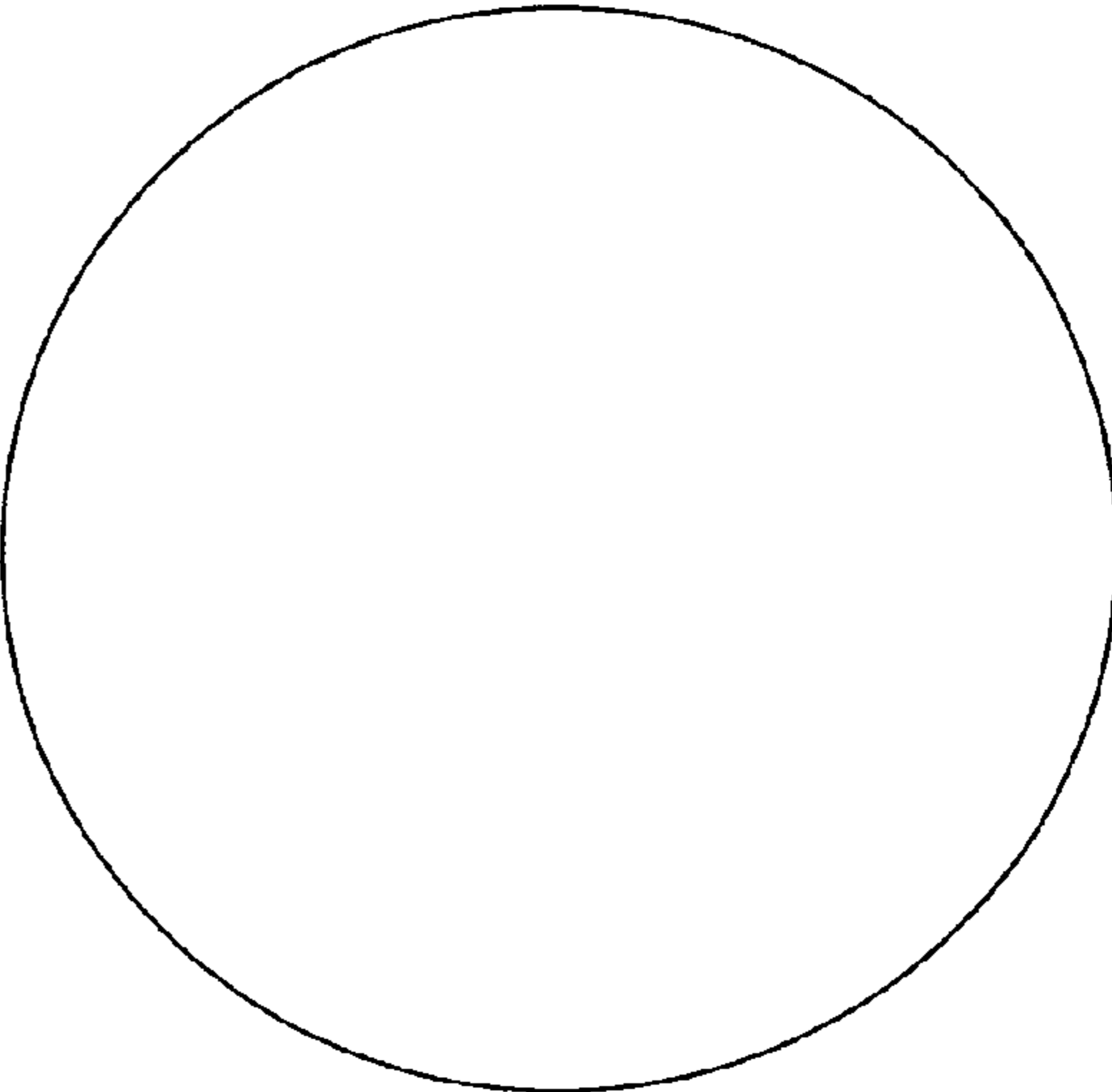

FIG.6