



(12) **United States Design Patent**
Bassam et al.

(10) **Patent No.:** **US D624,763 S**
(45) **Date of Patent:** **** Oct. 5, 2010**

(54) **SEATING**

(75) Inventors: **Craig John Bassam**, New Canaan, CT (US); **Christopher Scott Fellows**, New Canaan, CT (US)

(73) Assignee: **McGuire Furniture Company, Inc.**, San Francisco, CA (US)

(**) Term: **14 Years**

(21) Appl. No.: **29/314,390**

(22) Filed: **Oct. 4, 2007**

(51) **LOC (9) Cl.** **06-01**

(52) **U.S. Cl.** **D6/380**

(58) **Field of Classification Search** D6/334-336, D6/349, 360-369, 373-374, 379-380, 498, D6/500-502; 297/233, 284.4, 411.27, 440.16, 297/451.7, 452.13, 452.19, 452.21, 452.29, 297/452.3, 452.56, 452.64

See application file for complete search history.

(56) **References Cited**

U.S. PATENT DOCUMENTS

D149,982 S * 6/1948 Sundberg D6/373

(Continued)

Primary Examiner—Caron Veynar

Assistant Examiner—Ricky Pham

(74) *Attorney, Agent, or Firm*—Merchant & Gould PC

(57) **CLAIM**

The ornamental design for seating, as shown and described.

DESCRIPTION

FIG. 1 is a perspective view of a first embodiment of seating with a cushion thereon, according to the principles of the present invention;

FIG. 2 is a rear elevational view thereof without a cushion;

FIG. 3 is a front elevational view thereof;

FIG. 4 is a right side elevational view thereof, a left side elevational view not being shown as it is a mirror image of the right side elevational view;

FIG. 5 is a top plan view thereof;

FIG. 6 is a bottom plan view thereof;

FIG. 7 is a perspective view of a second embodiment of seating having a cushion thereon;

FIG. 8 is a rear elevational view thereof without a cushion;

FIG. 9 is a front elevational view thereof;

FIG. 10 is a right side elevational view thereof, a left side elevational view not being shown as it is a mirror image of the right side elevational view;

FIG. 11 is a top plan view thereof;

FIG. 12 is a bottom plan view thereof;

FIG. 13 is a perspective view of a third embodiment of seating with a cushion thereon;

FIG. 14 is a rear elevational view thereof;

FIG. 15 is a front elevational view thereof;

FIG. 16 is a right side elevational view thereof, a left side elevational view not being shown as it is a mirror image of the right side elevational view;

FIG. 17 is a top plan view thereof;

FIG. 18 is a bottom plan view thereof;

FIG. 19 is a perspective view of a fourth embodiment of seating with cushions thereon;

FIG. 20 is a rear elevational view thereof without cushions;

FIG. 21 is a front elevational view thereof;

FIG. 22 is a right sided elevational view thereof, a left side elevational view not being shown as it is a mirror image of the right side elevational view;

FIG. 23 is a top plan view thereof; and,

FIG. 24 is a bottom plan view thereof.

1 Claim, 24 Drawing Sheets

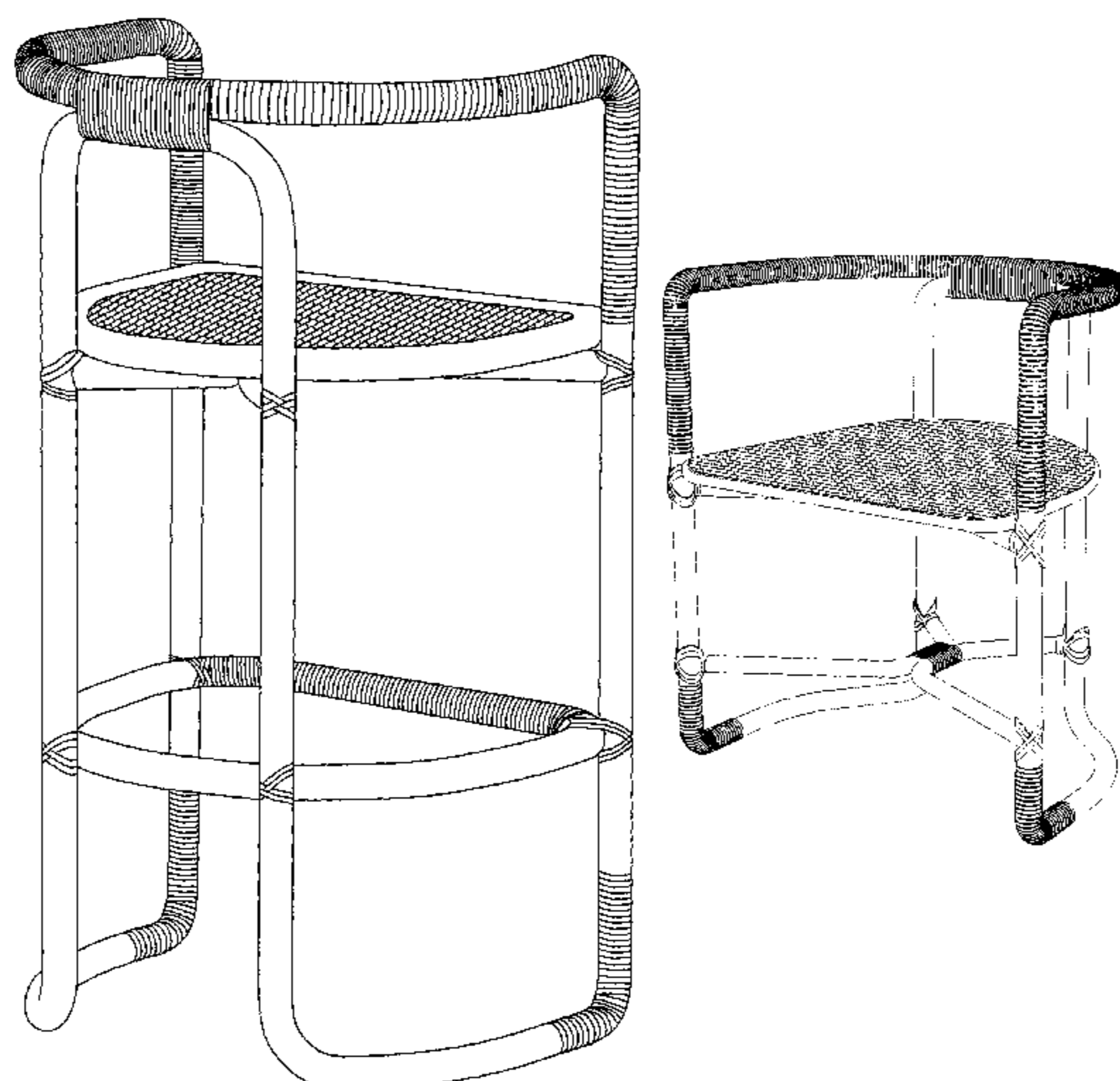

US D624,763 S

Page 2

U.S. PATENT DOCUMENTS

D230,793 S	3/1974	Meyer et al.		D413,448 S	9/1999	Navone	
4,097,089 A *	6/1978	Petersen	297/451.7	D418,687 S	1/2000	Tihany	
D248,432 S *	7/1978	Petersen	D6/373	D421,851 S	3/2000	Tihany	
D265,356 S *	7/1982	Berlic	D6/369	D421,852 S	3/2000	Tihany	
D282,887 S	3/1986	Claman		D421,853 S	3/2000	Black	
4,586,751 A	5/1986	McQuire		D422,156 S	4/2000	Black	
D334,295 S	3/1993	Wisner		D422,422 S	4/2000	Black	
D340,590 S	10/1993	McGuire et al.		D423,804 S	5/2000	Tihany	
D345,868 S	4/1994	McGuire et al.		D424,825 S	5/2000	Tihany	
5,308,146 A *	5/1994	Chou	297/440.16	D427,795 S	7/2000	Tihany	
D349,196 S	8/1994	Lohmeyer		D439,068 S	3/2001	Vanderbyl	
D353,739 S	12/1994	Stein		D445,575 S	7/2001	Shepard	
5,632,524 A *	5/1997	Ikeda et al.	297/233	D446,956 S	8/2001	Black	
D380,105 S	6/1997	Diaz-Azcuy		D448,939 S	10/2001	Shepard	
D380,307 S	7/1997	Diaz-Azcuy		D450,944 S	11/2001	Shepard et al.	
D380,308 S	7/1997	Diaz-Azcuy		D460,872 S	7/2002	Diaz-Azcuy	
D380,309 S	7/1997	Diaz-Azcuy		D461,065 S	8/2002	Diaz-Azcuy	
D380,310 S	7/1997	Diaz-Azcuy		D461,969 S	8/2002	Diaz-Azcuy	
D380,311 S	7/1997	Diaz-Azcuy		6,491,345 B1	12/2002	Shepard	
D380,312 S	7/1997	Diaz-Azcuy		D472,723 S *	4/2003	Haney et al.	D6/373
D386,912 S	12/1997	Diaz-Azcuy		D477,720 S	7/2003	Diaz-Azcuy	
D390,031 S	2/1998	Diaz-Azcuy		D495,512 S	9/2004	Diaz-Azcuy	
D395,174 S	6/1998	Diaz-Azcuy		D505,034 S	5/2005	Barry	
D411,693 S	6/1999	Navone		D575,540 S *	8/2008	Goldberg et al.	D6/349
D412,408 S	8/1999	Navone		D579,676 S *	11/2008	Rheault et al.	D6/349

* cited by examiner

FIG. 1

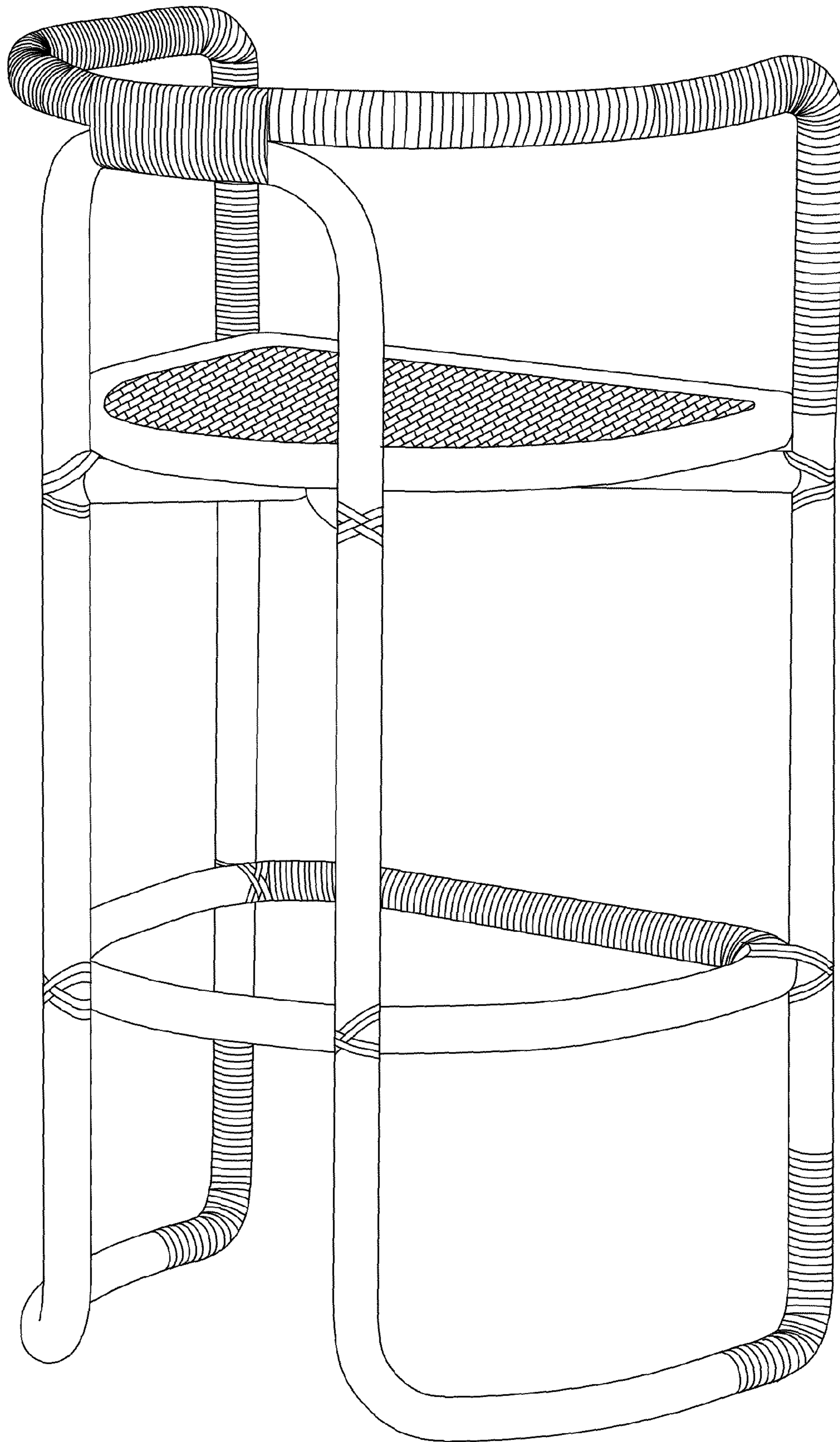

FIG.2

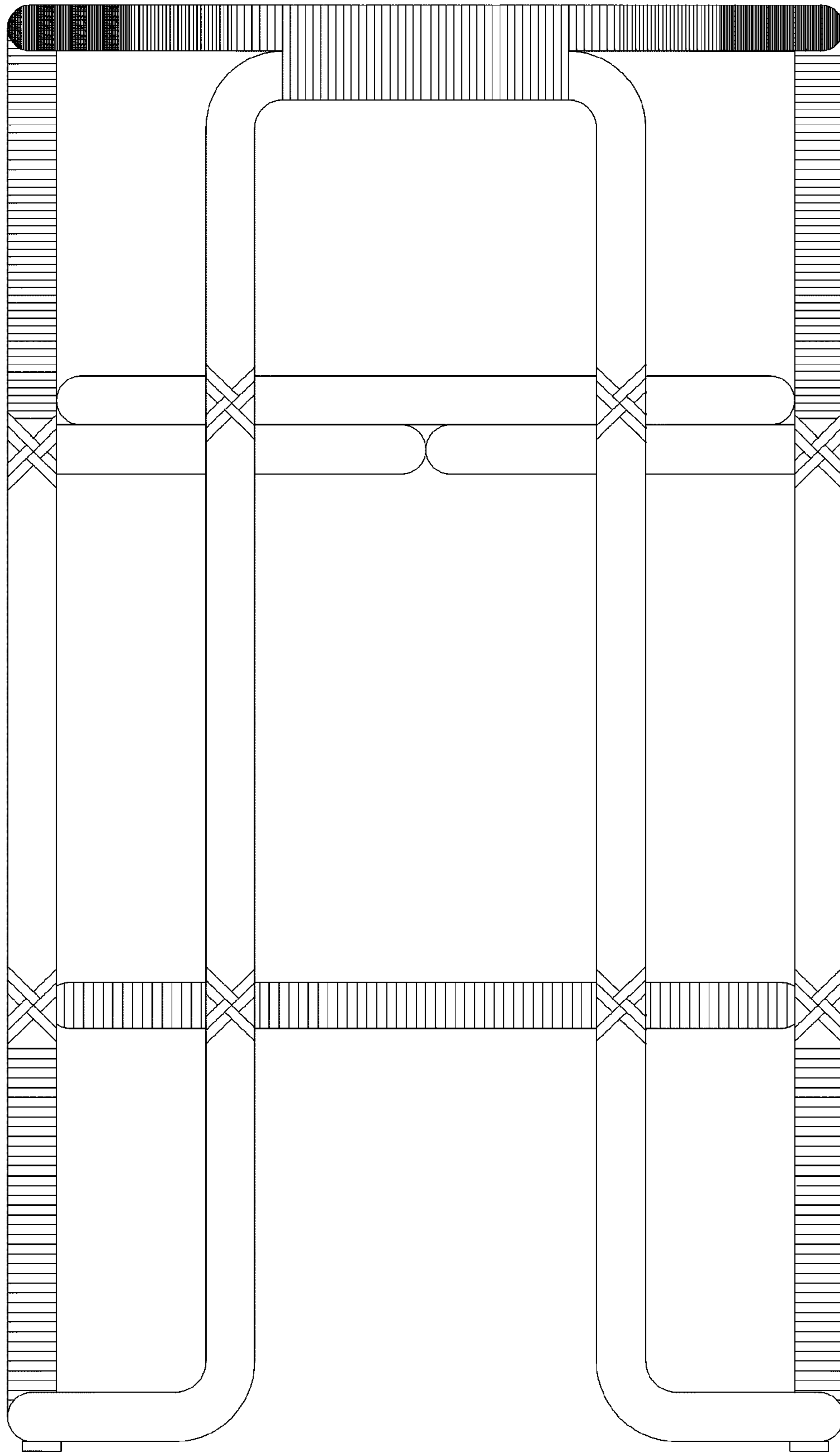

FIG.3

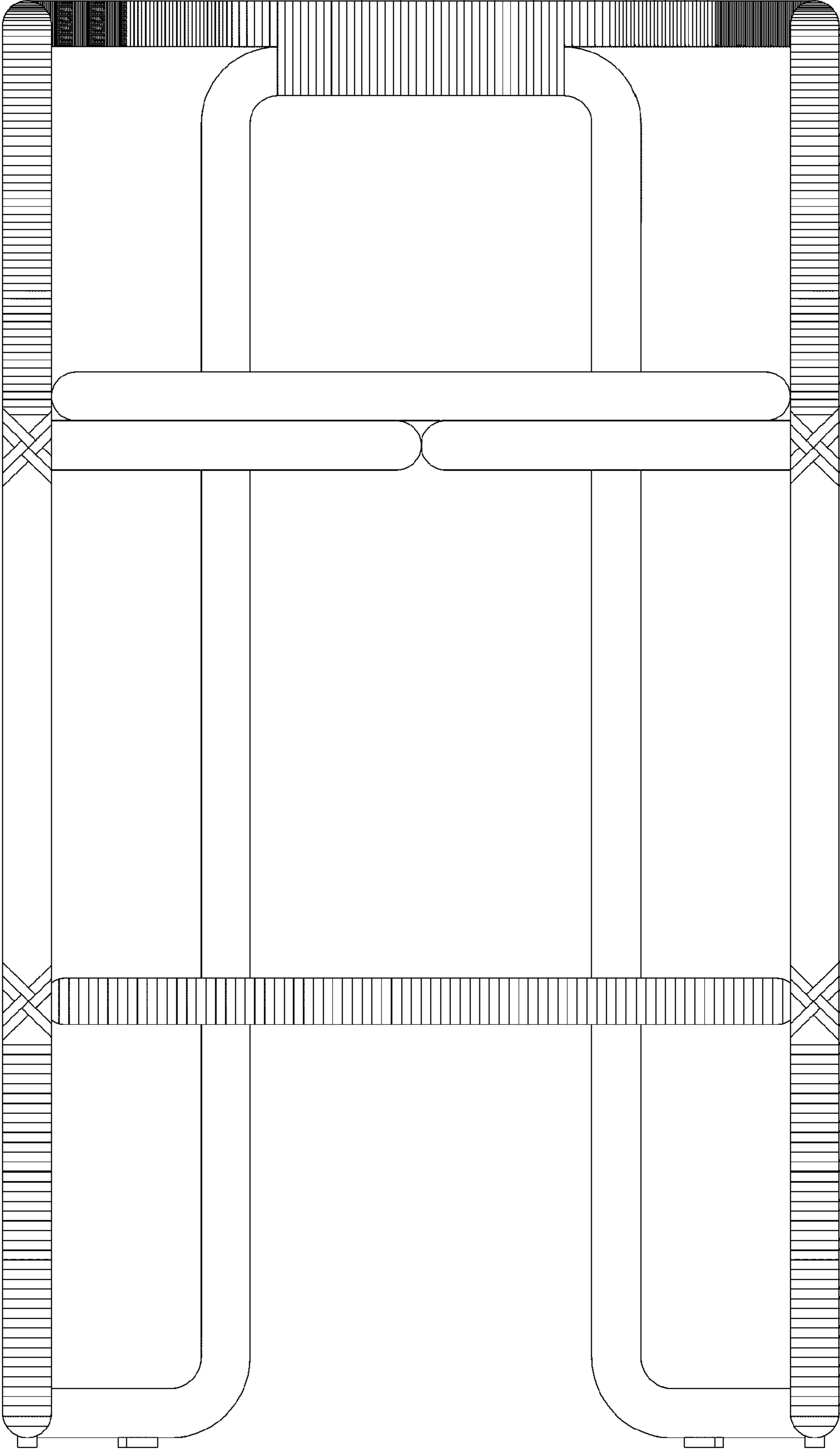

FIG.4

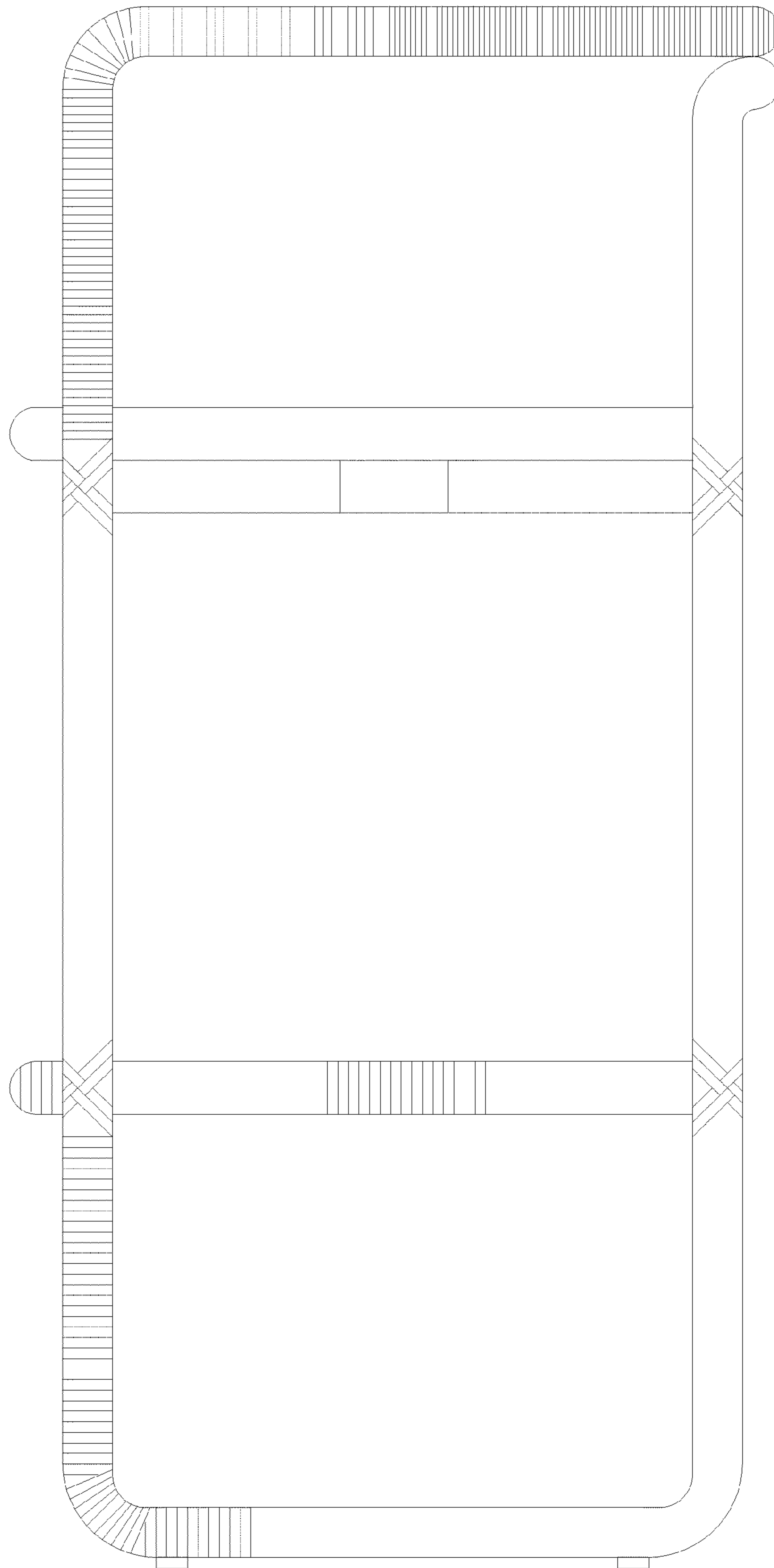

FIG.5

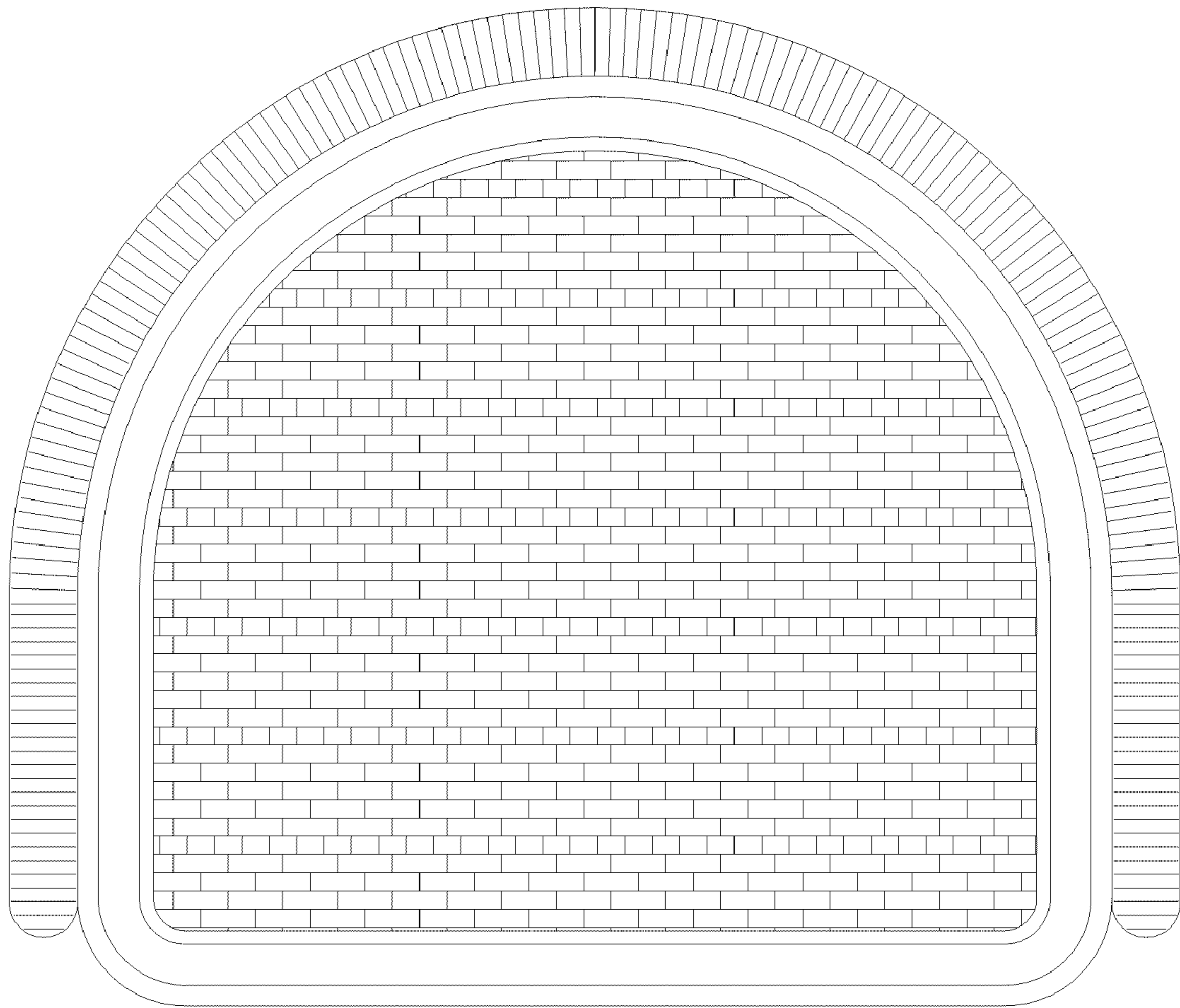

FIG. 6

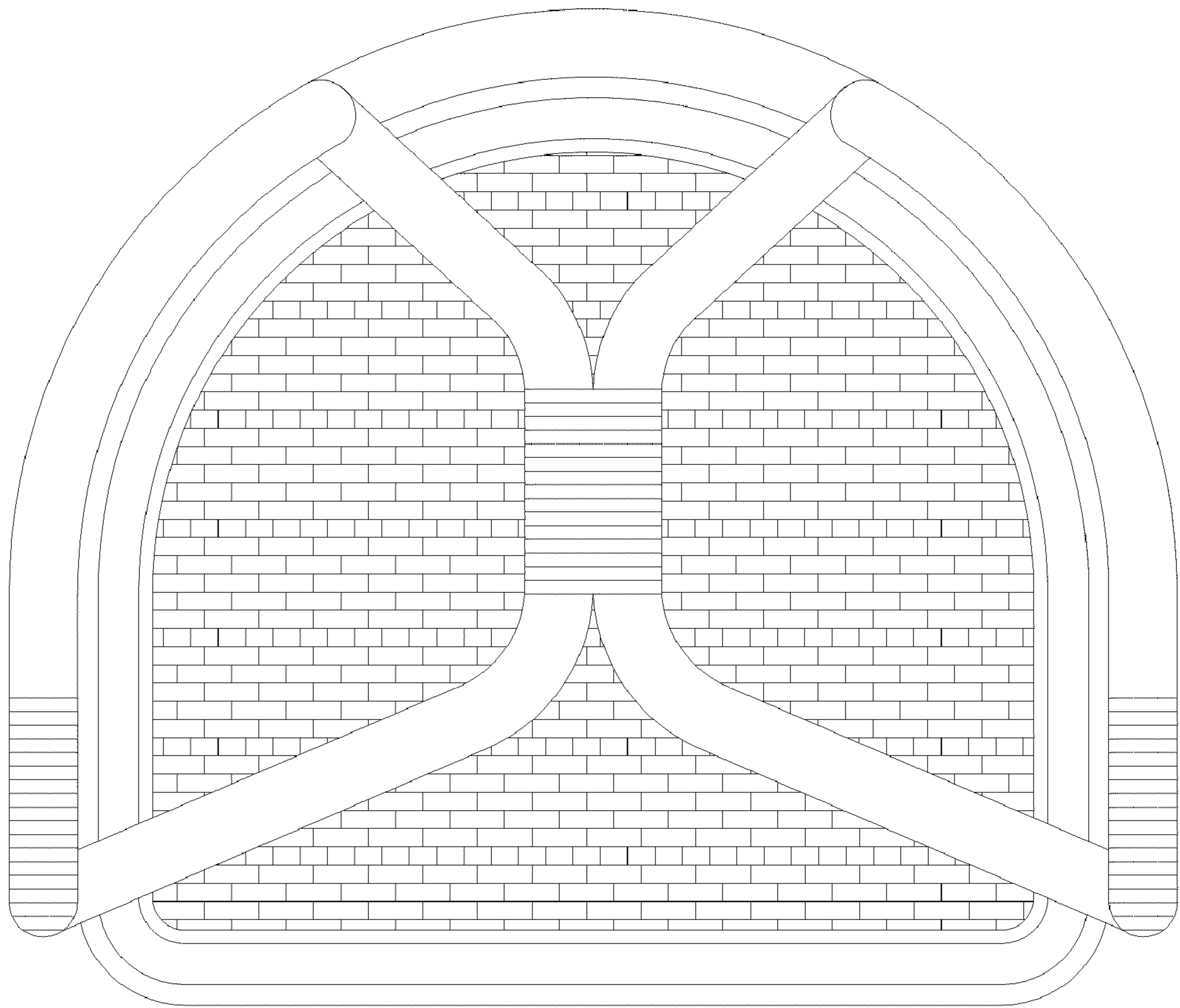

FIG. 7

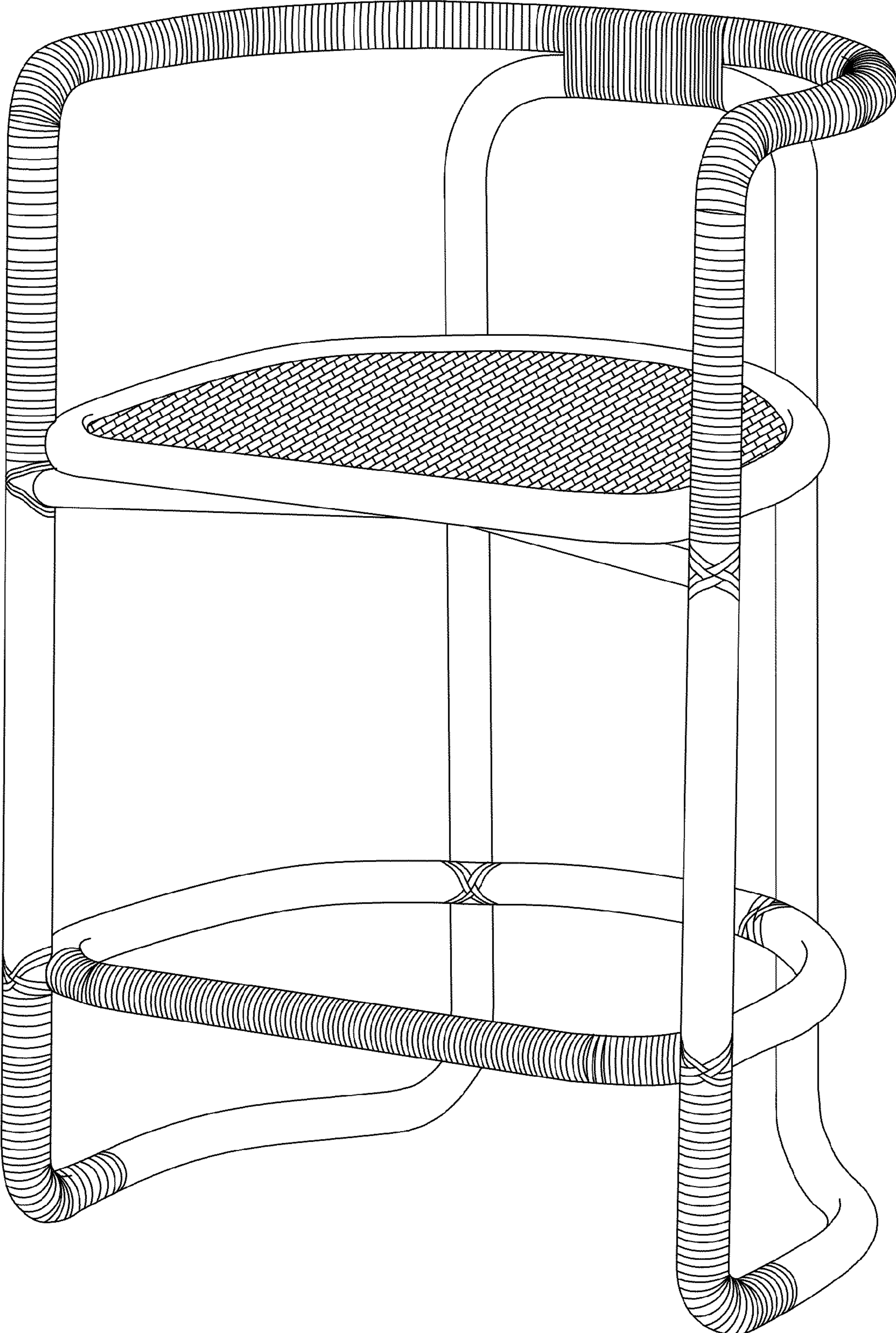

FIG. 8

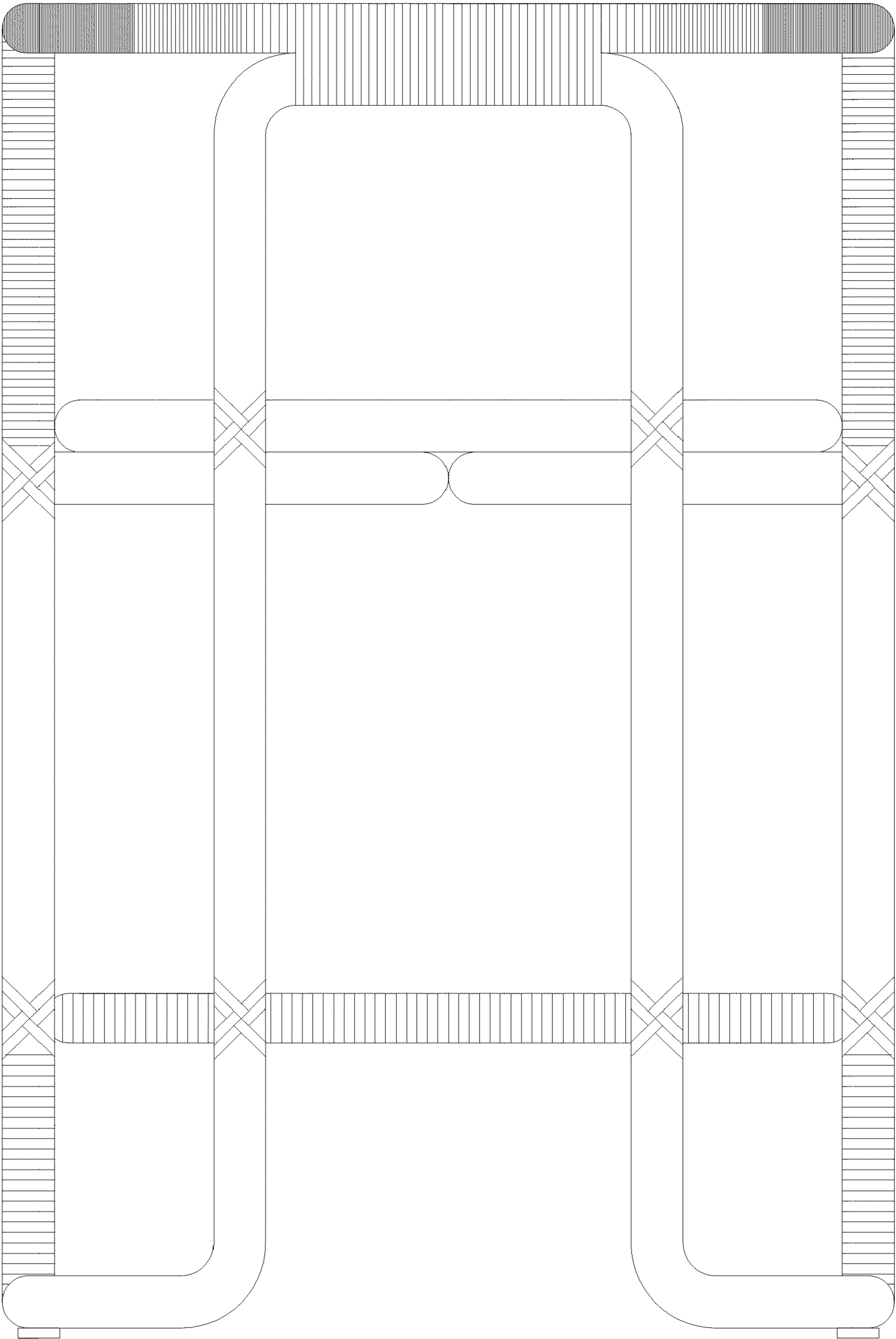

FIG. 9

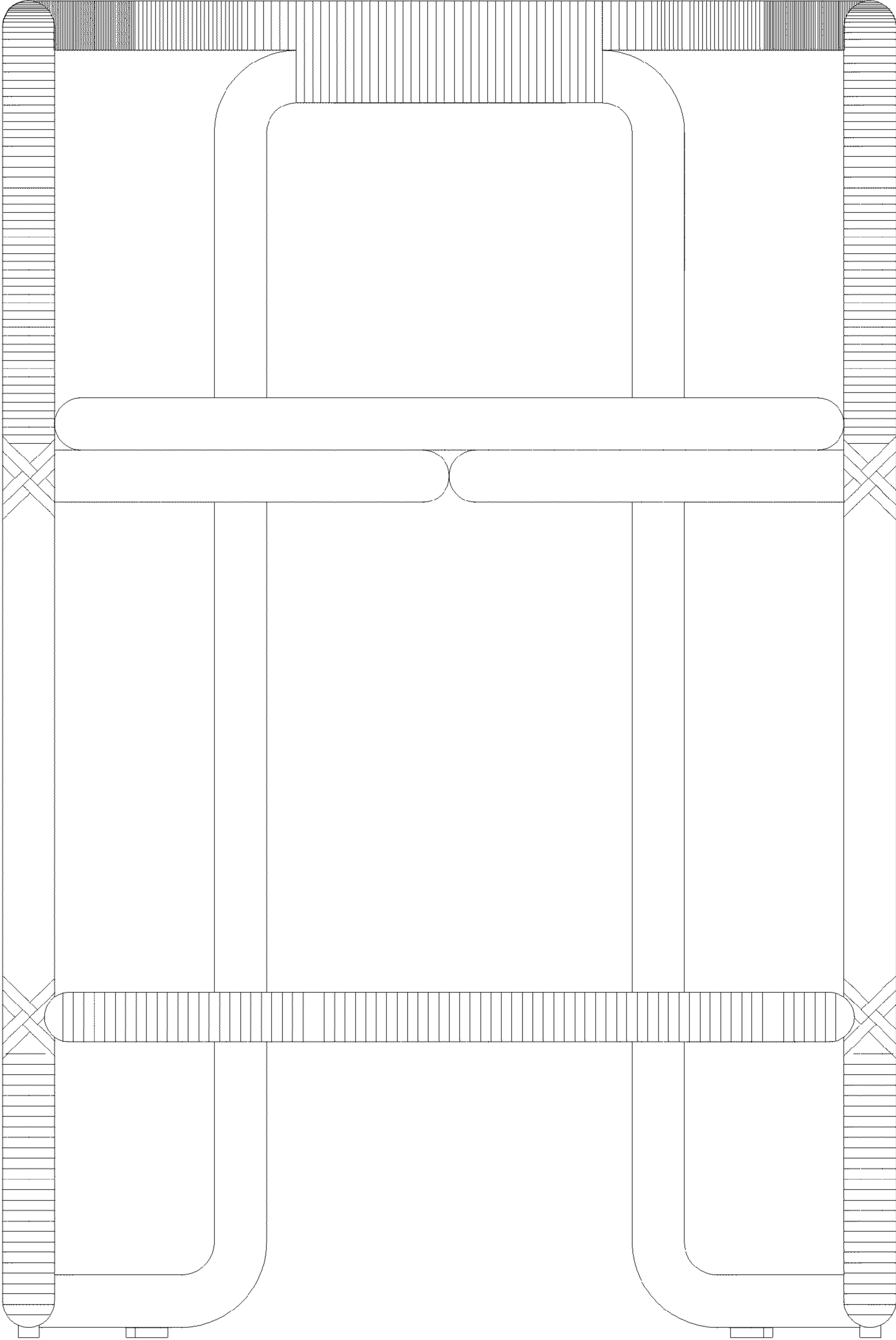

FIG. 10

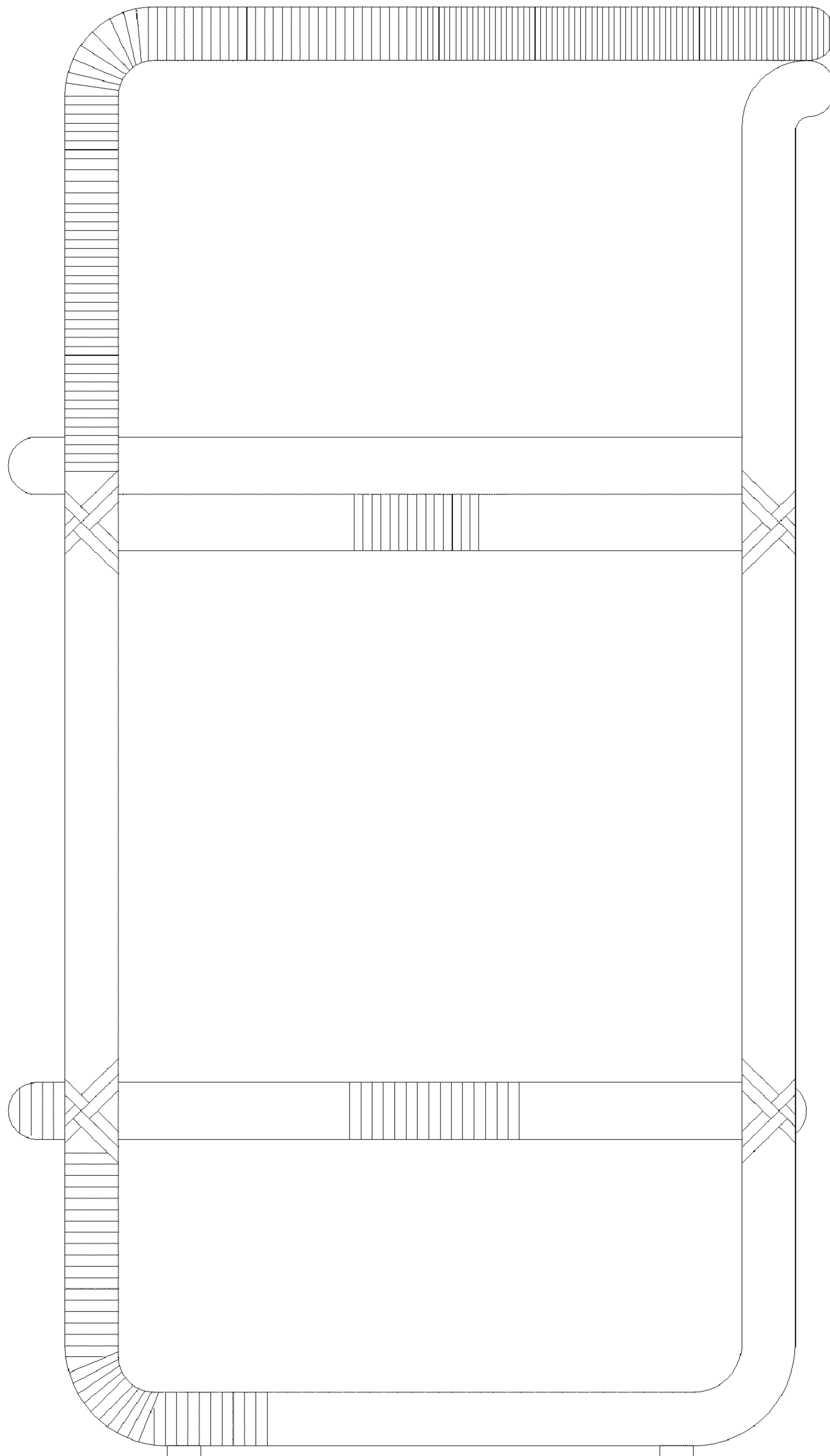

FIG. 11

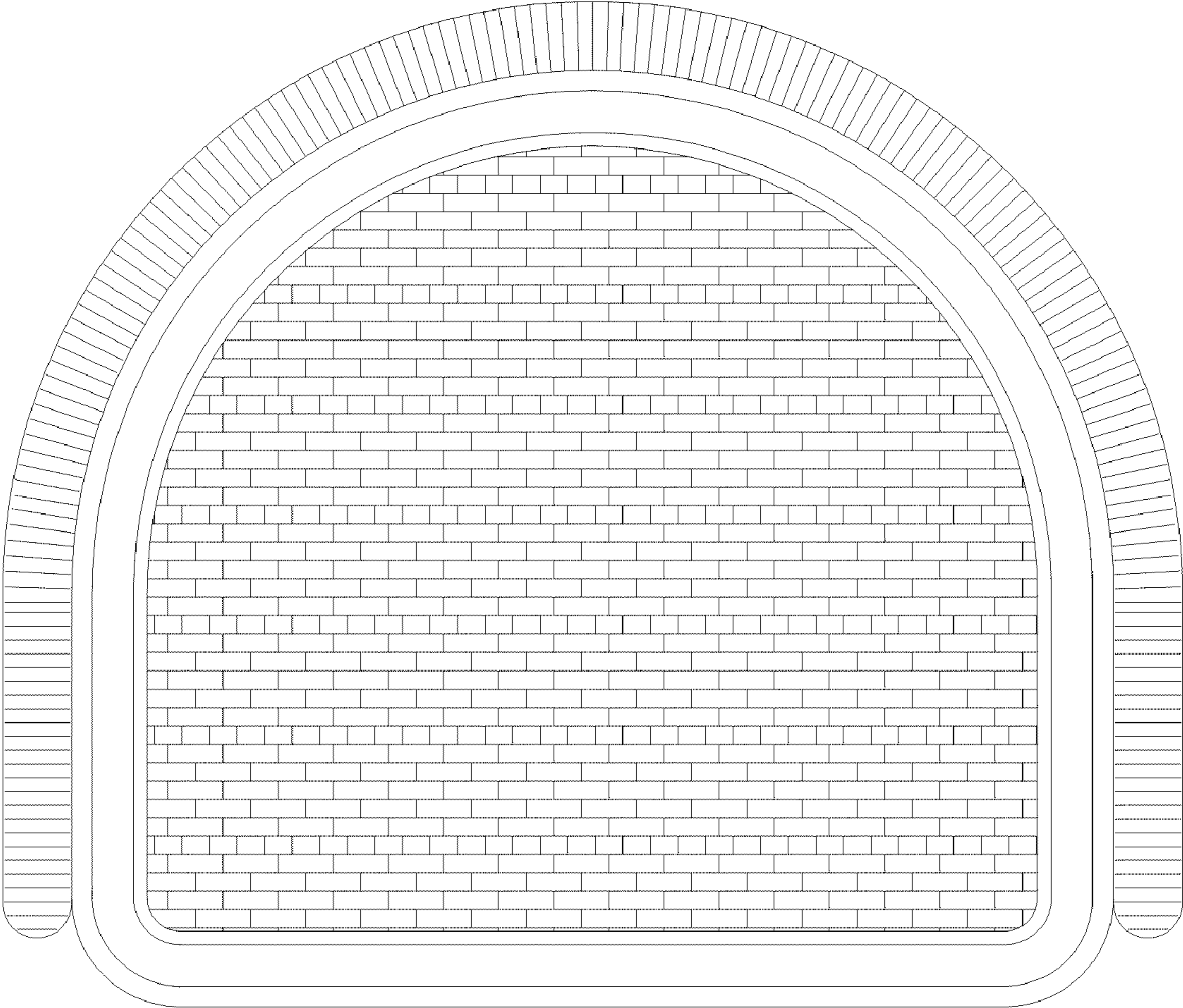

FIG. 12

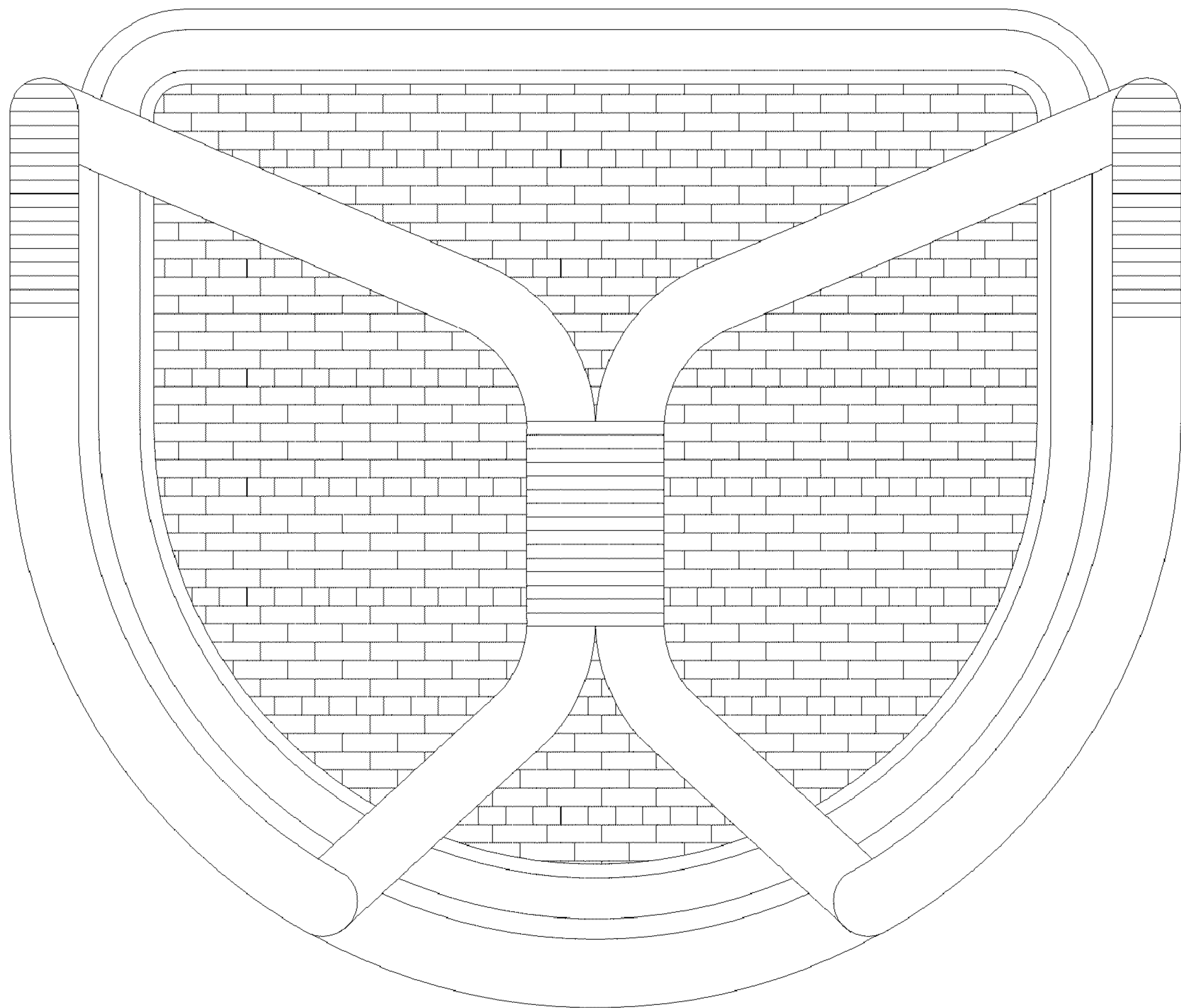

FIG. 13

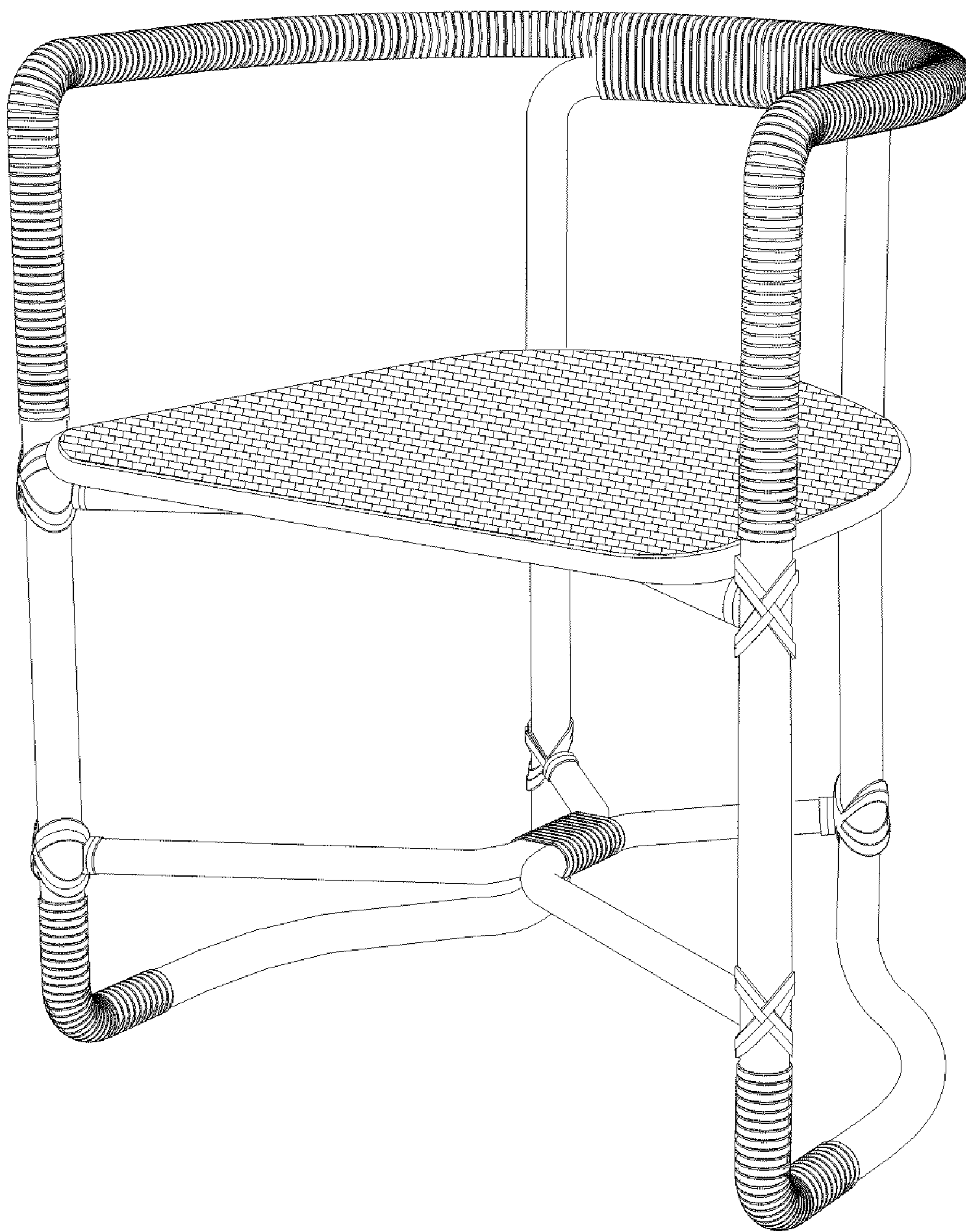

FIG. 14

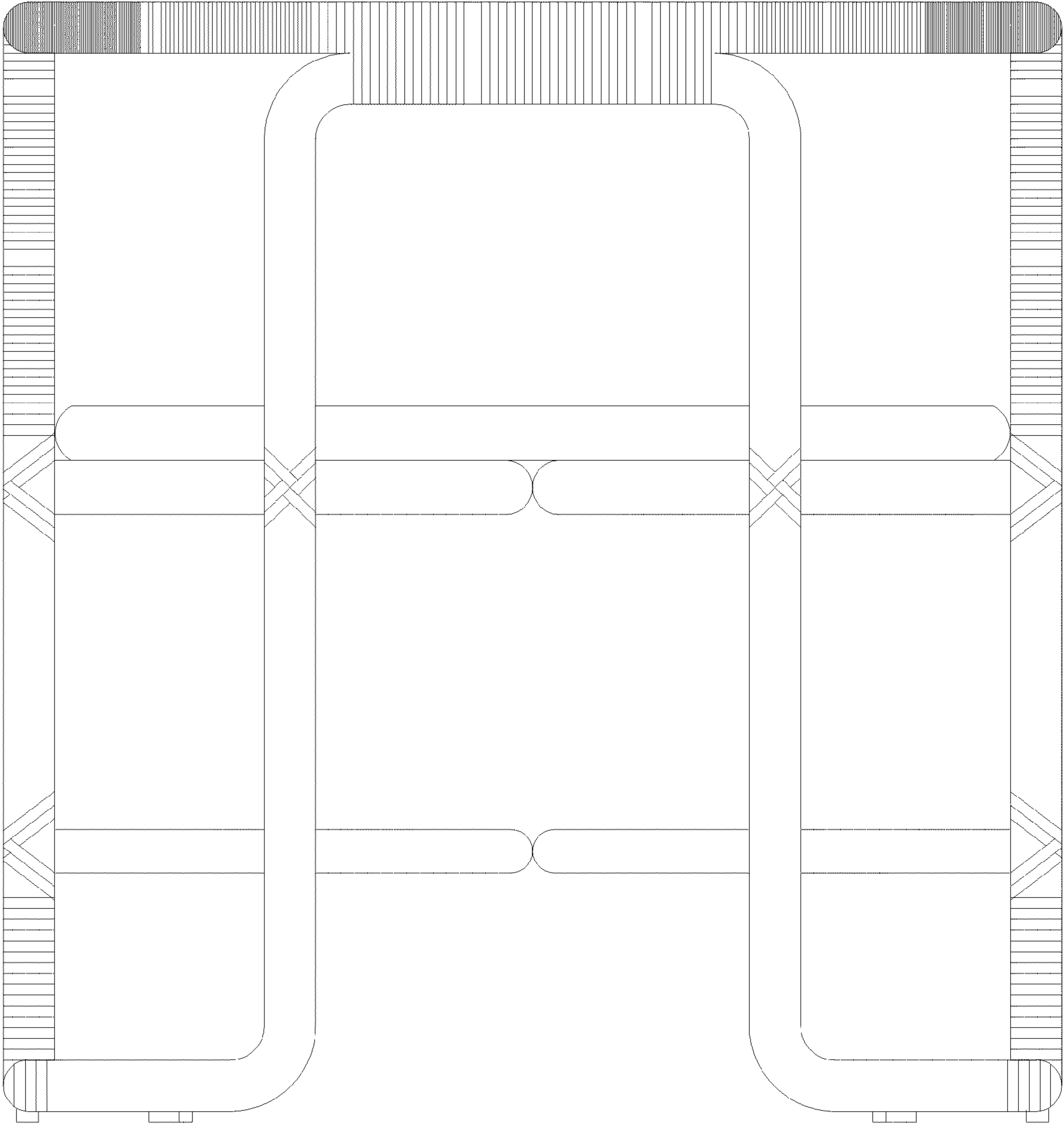

FIG. 15

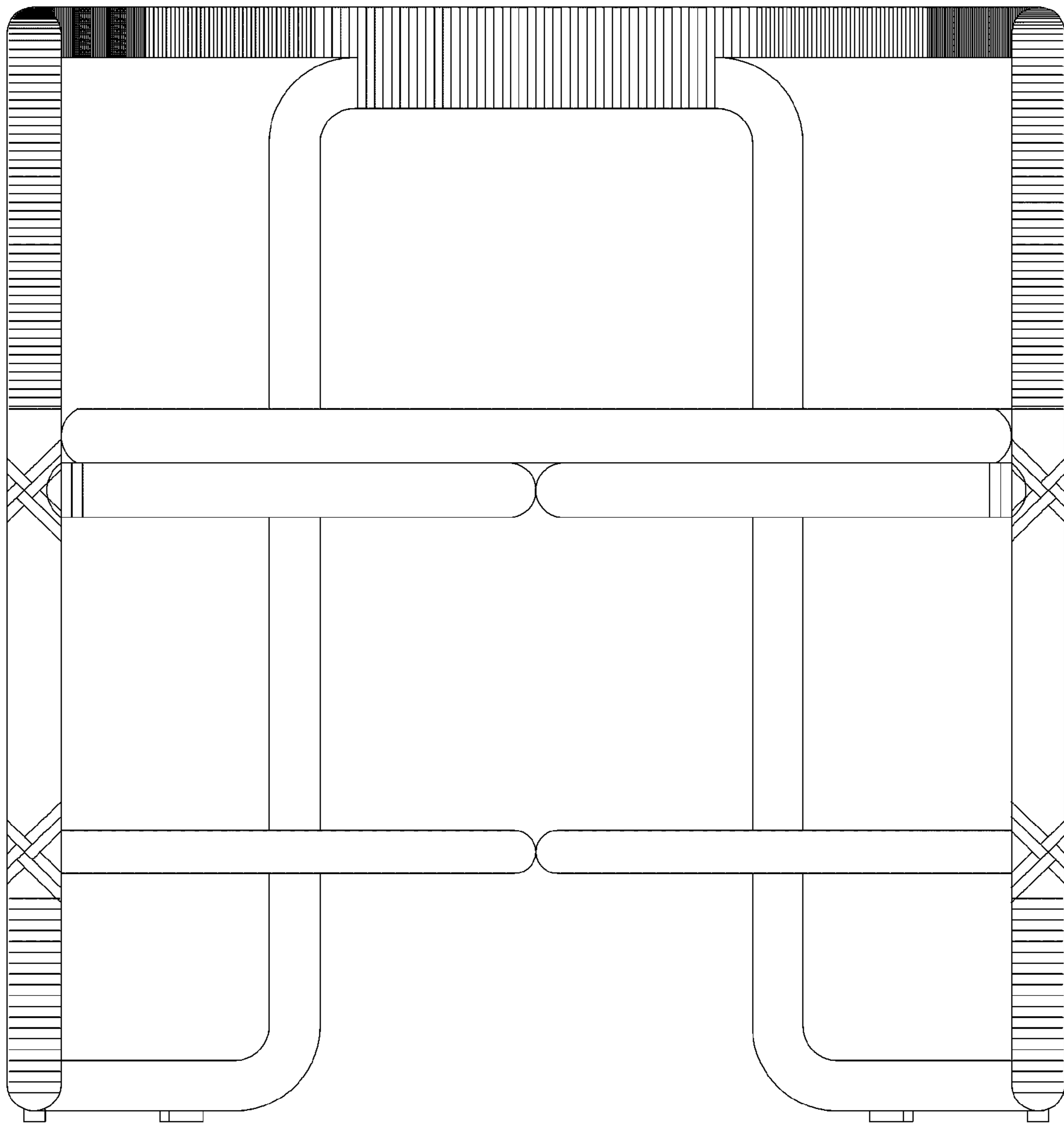

FIG. 16

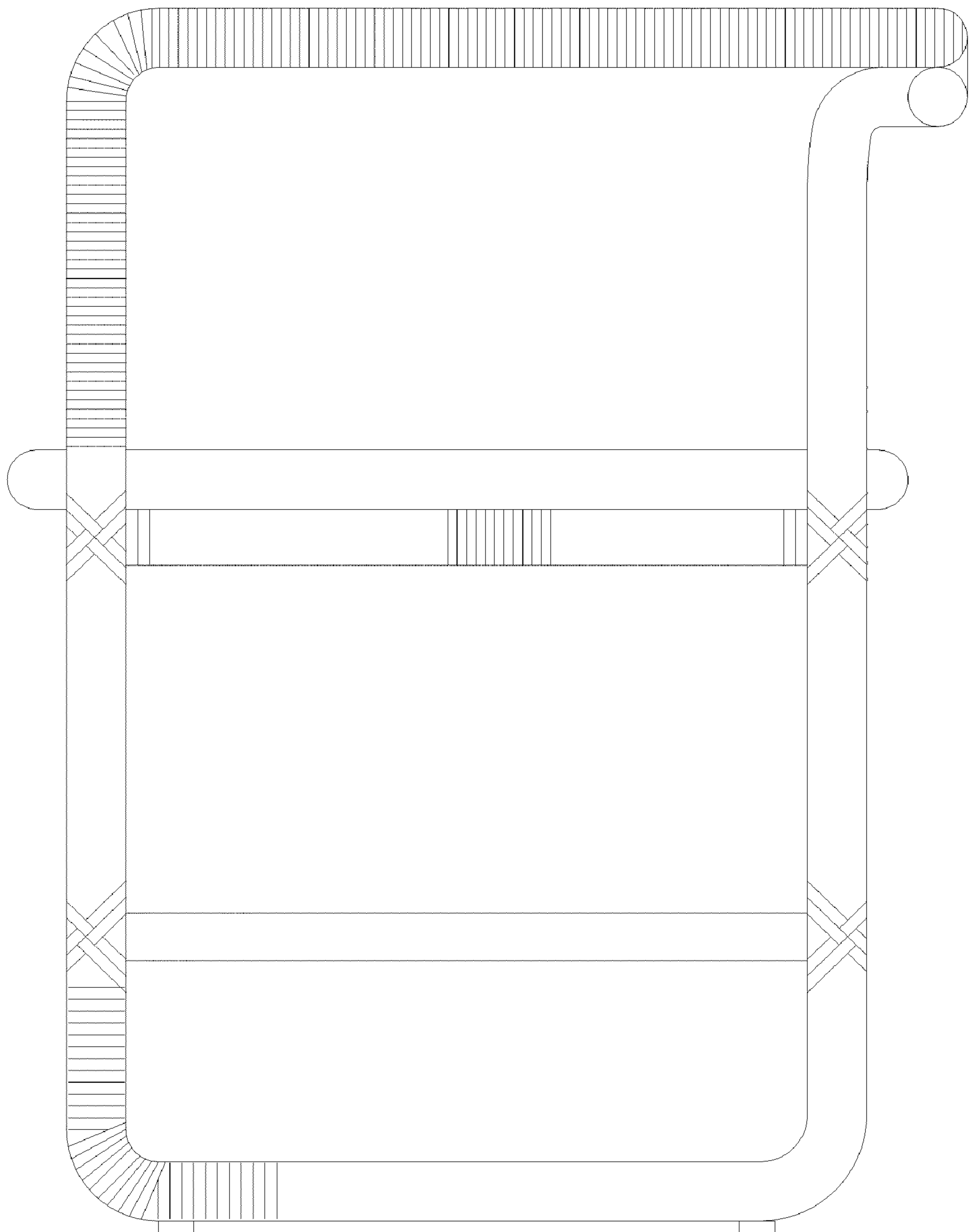

FIG. 17

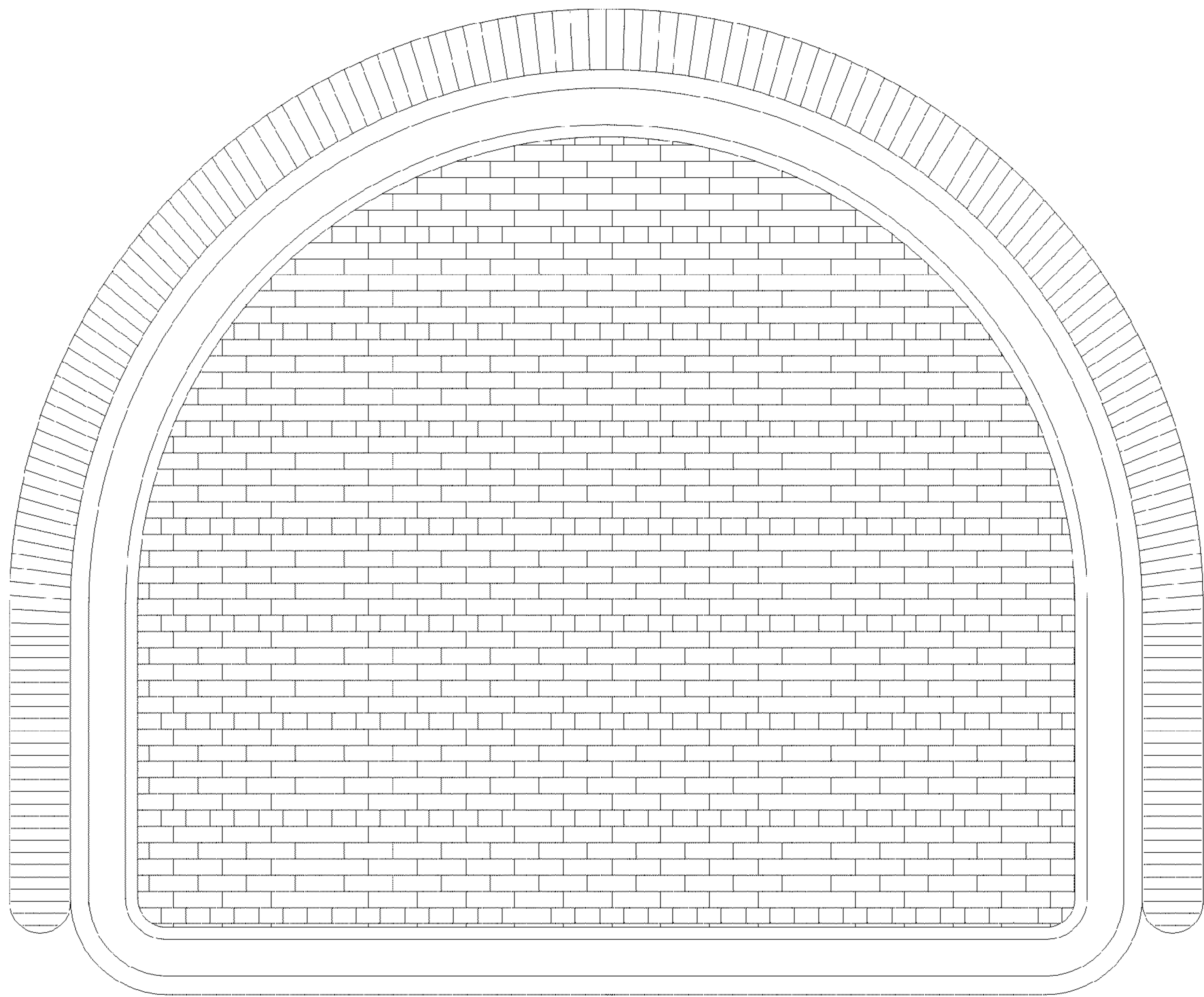

FIG. 18

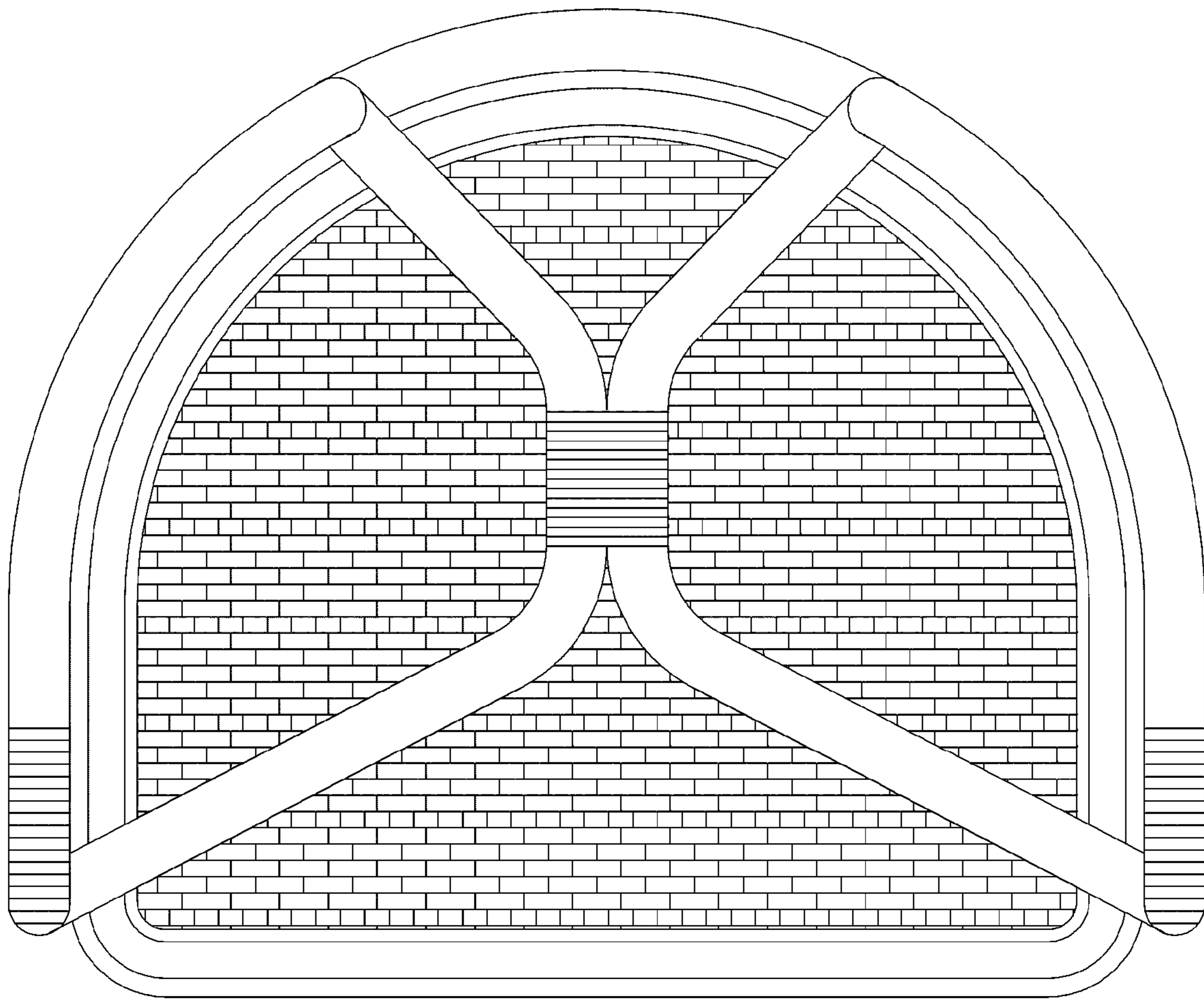

FIG. 19

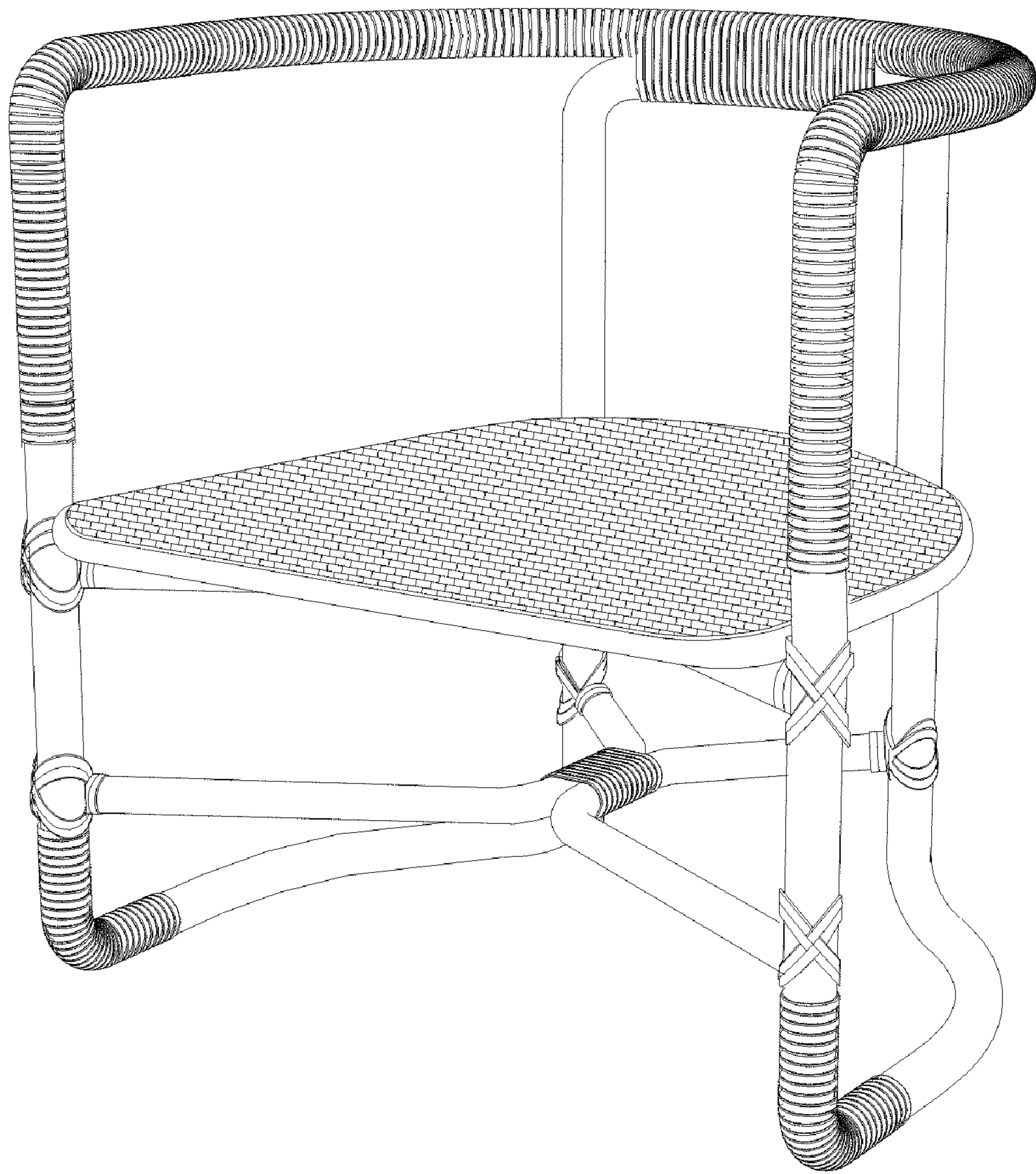

FIG.20

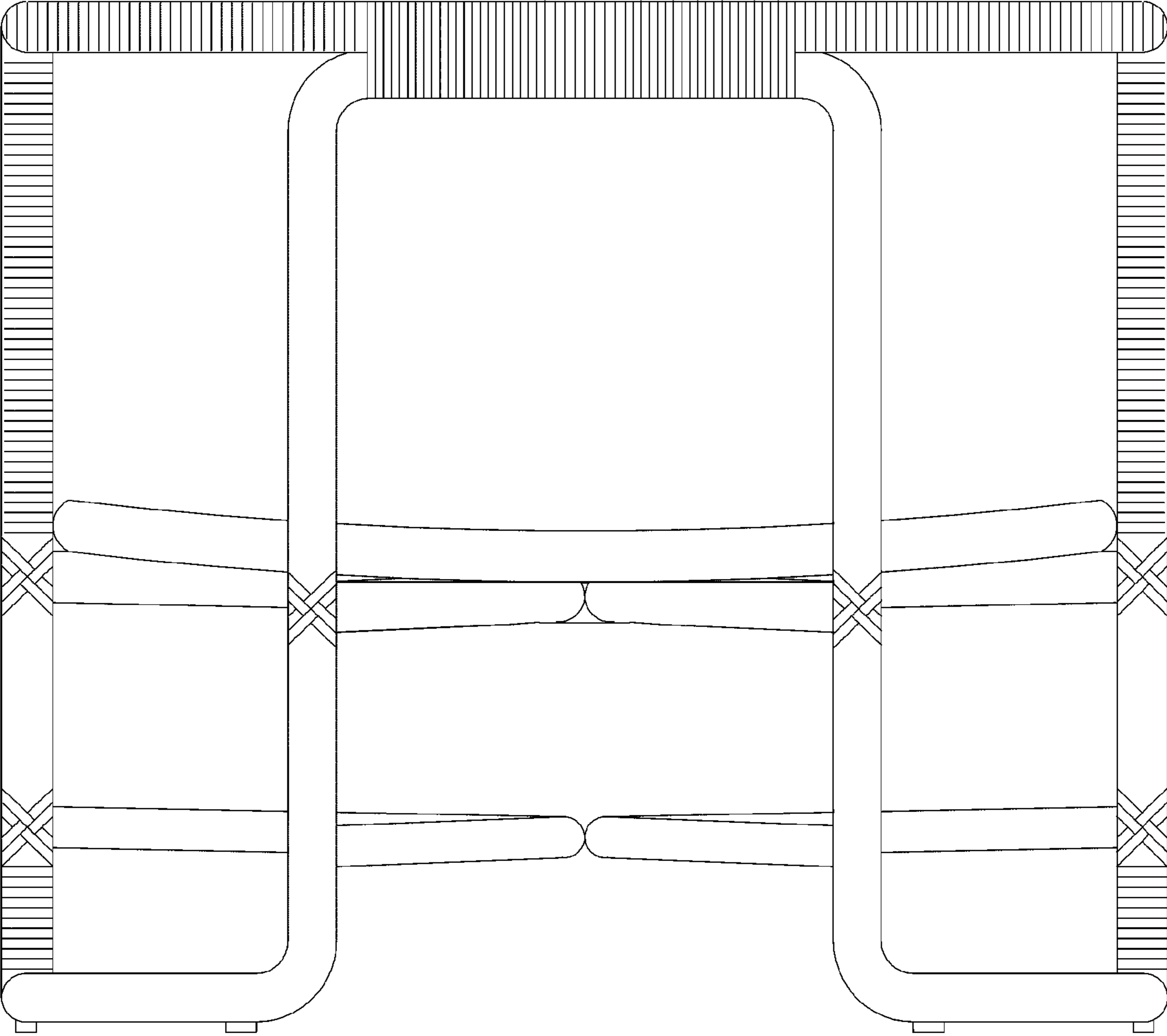

FIG.21

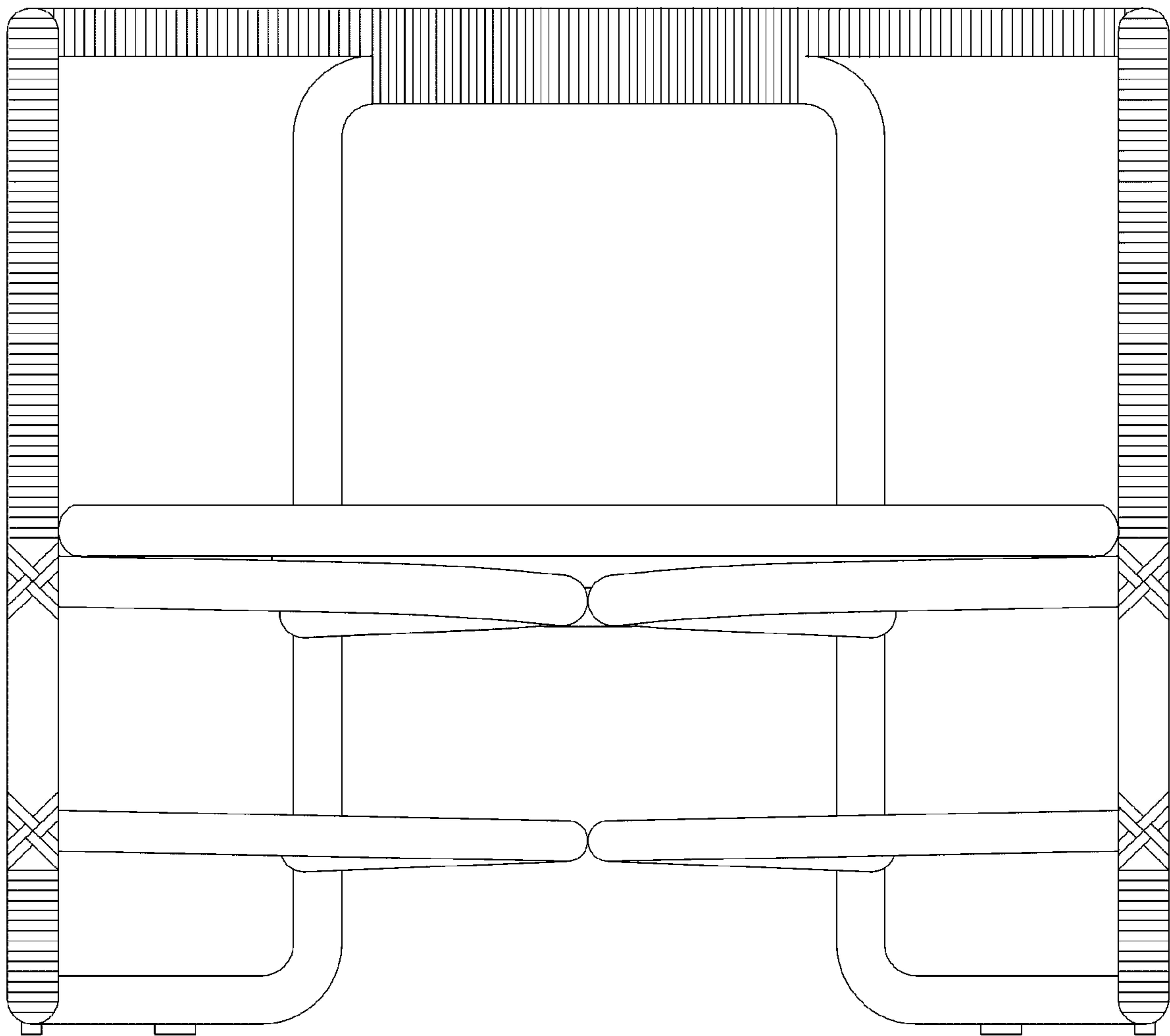

FIG.22

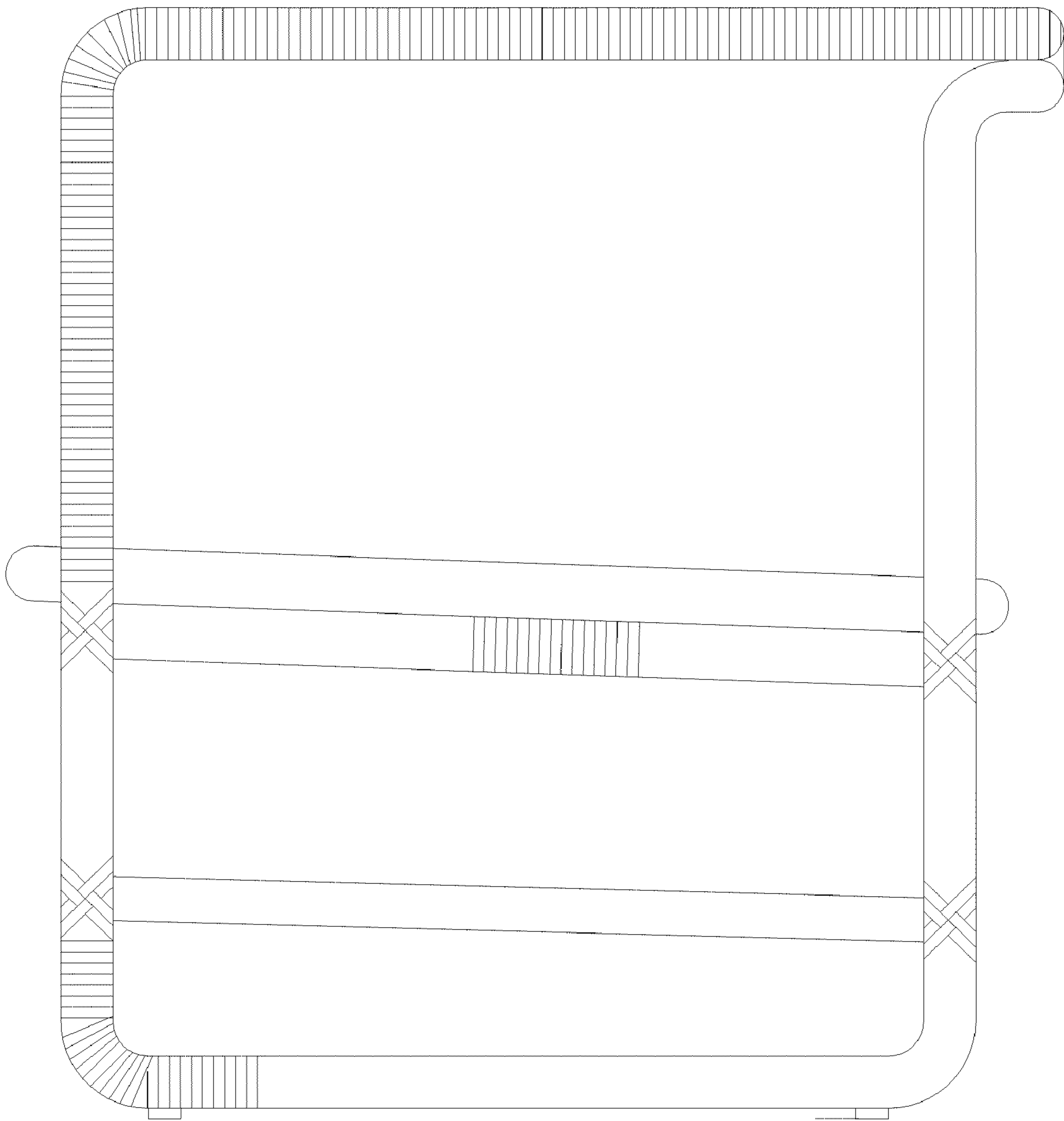

FIG.23

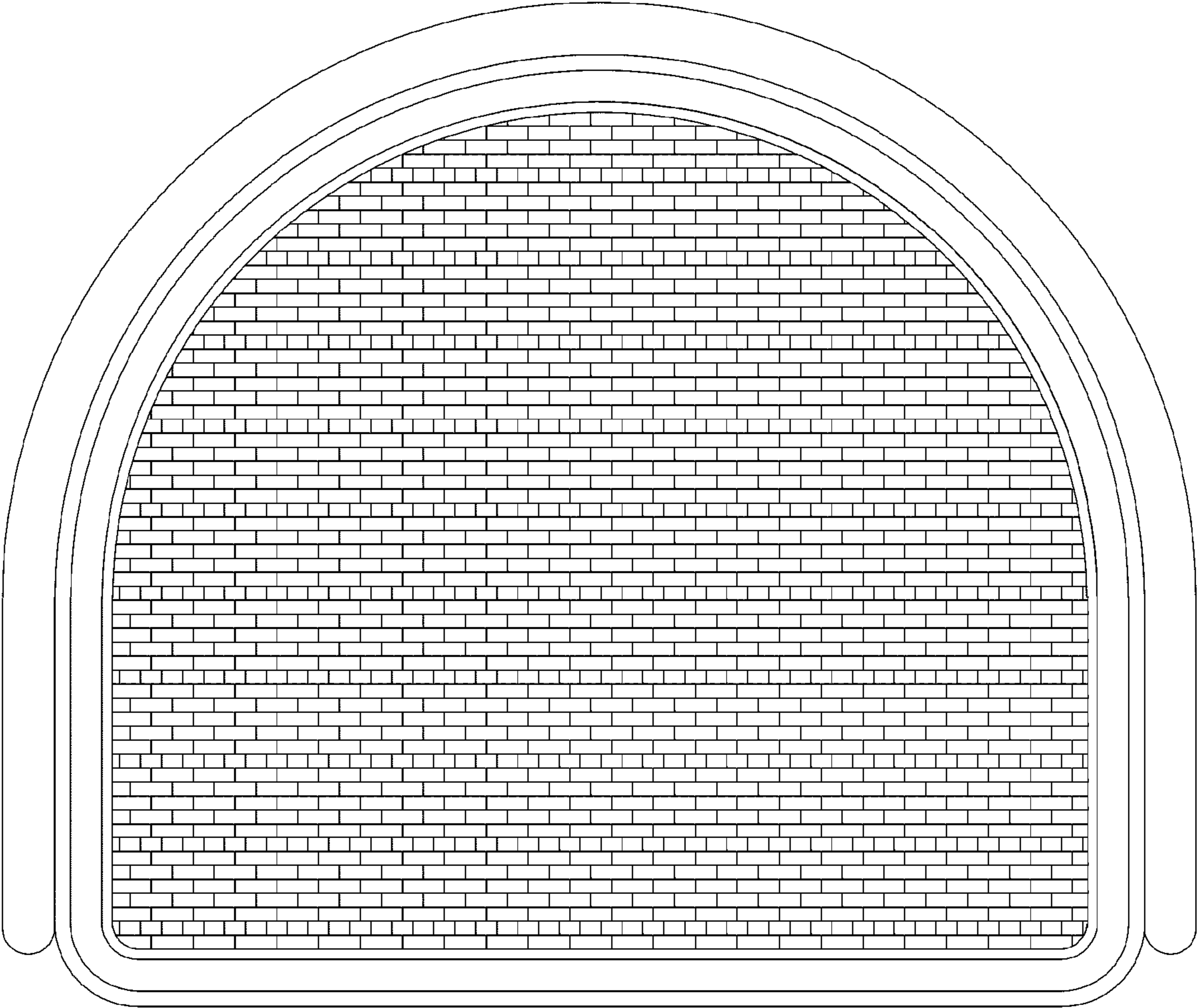

FIG.24

