



US00D624746S

(12) **United States Design Patent**
Leung et al.

(10) **Patent No.:** **US D624,746 S**
(45) **Date of Patent:** **** Oct. 5, 2010**

(54) **UMBRELLA**

D466,685 S * 12/2002 Gref D3/11

(75) Inventors: **Pak Keung David Leung**, Kowloon (HK); **Pui Kay Mo Mou**, Kowloon (HK)

* cited by examiner

Primary Examiner—Doris Clark

(73) Assignee: **Ofess Limited**, Kowloon (HK)

(57) **CLAIM**

(**) Term: **14 Years**

The ornamental design for an umbrella, as shown and described.

(21) Appl. No.: **29/352,073**

(22) Filed: **Dec. 16, 2009**

DESCRIPTION

(30) **Foreign Application Priority Data**

FIG. 1 is a front elevational view of an umbrella showing my new design;

Jun. 19, 2009 (HK) 0900995

FIG. 2 is a rear elevational view thereof;

(51) **LOC (9) Cl.** **03-03**

FIG. 3 is a right side view thereof;

(52) **U.S. Cl.** **D3/11**

FIG. 4 is a left side view thereof;

(58) **Field of Classification Search** D3/5,
D3/10, 12, 13, 16, 17, 11; 135/15.1, 23,
135/20.1, 20.3, 25.31, 33.7, 39, 40, 25.01,
135/21, 16, 44

FIG. 5 is a top plan view thereof;

FIG. 6 is a bottom plan view thereof;

See application file for complete search history.

FIG. 7 is a perspective view thereof;

FIG. 8 is a perspective view with the umbrella being partly removed from the casing;

(56) **References Cited**

U.S. PATENT DOCUMENTS

FIG. 9 is a perspective view with the umbrella being completely removed from the casing; and,

5,111,835 A * 5/1992 Lin 135/34.2
6,079,430 A * 6/2000 Yamamoto 135/16
6,164,304 A * 12/2000 Headley 135/34.2

FIG. 10 is a perspective view with the umbrella being opened.

1 Claim, 9 Drawing Sheets

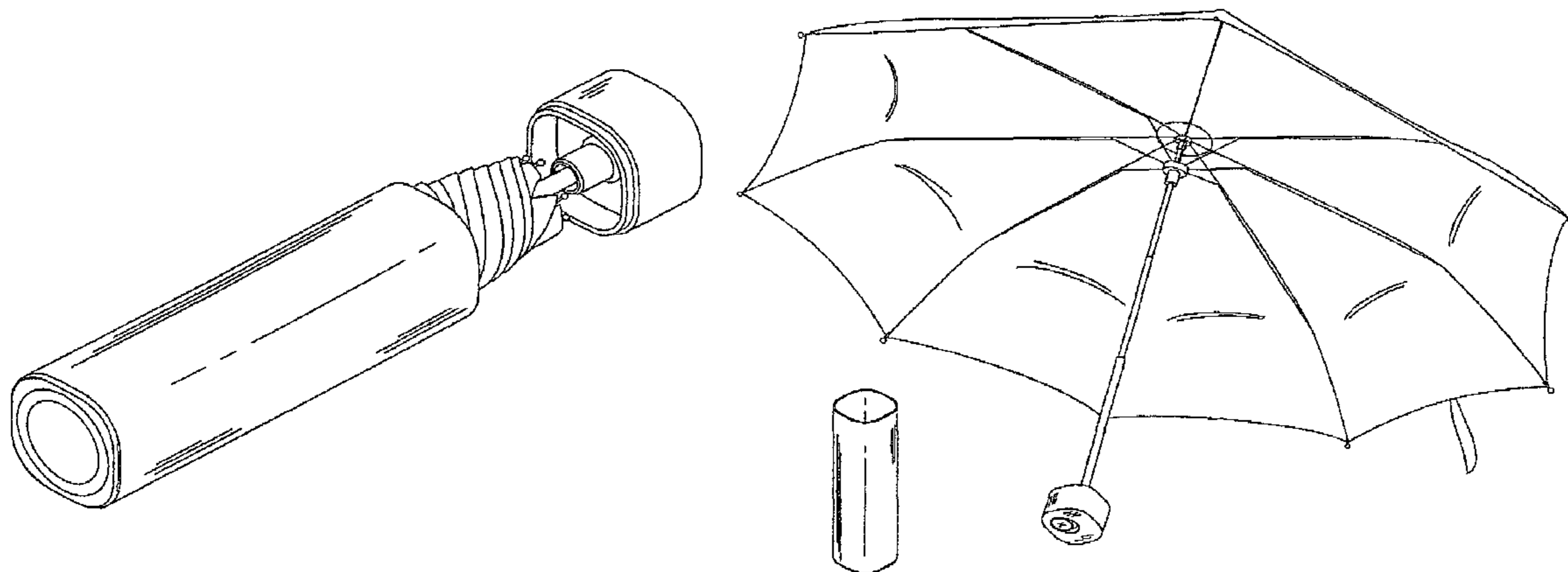

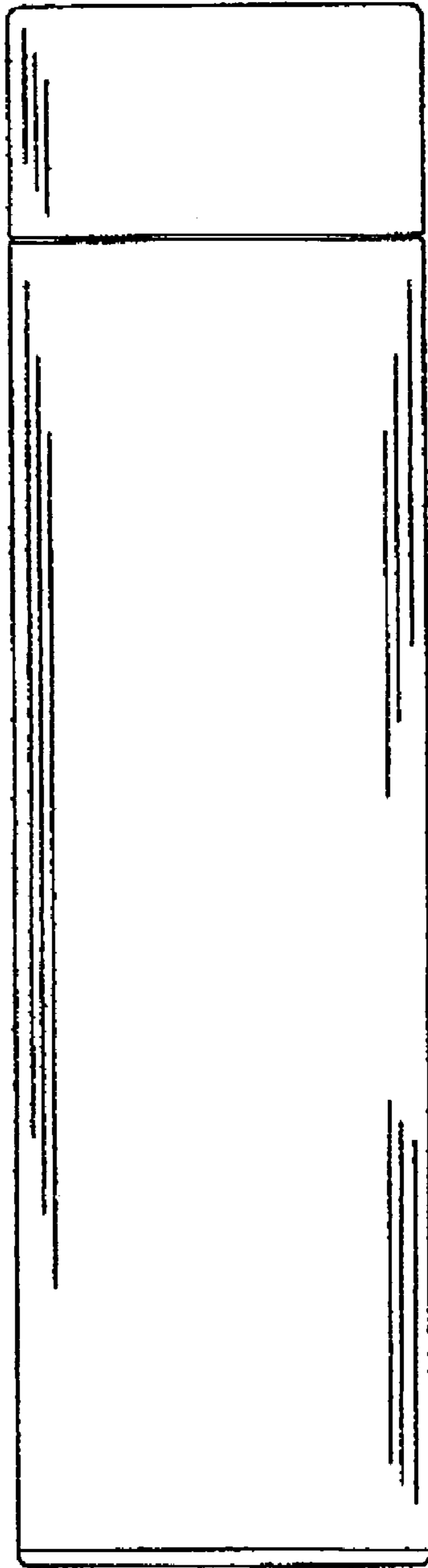

FIG. 1

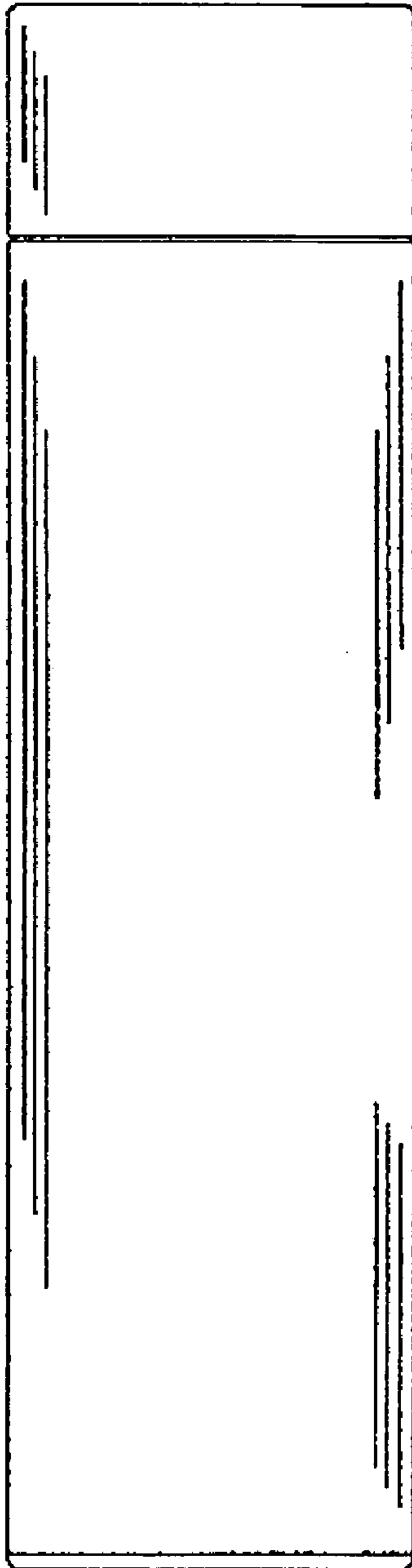

FIG. 2

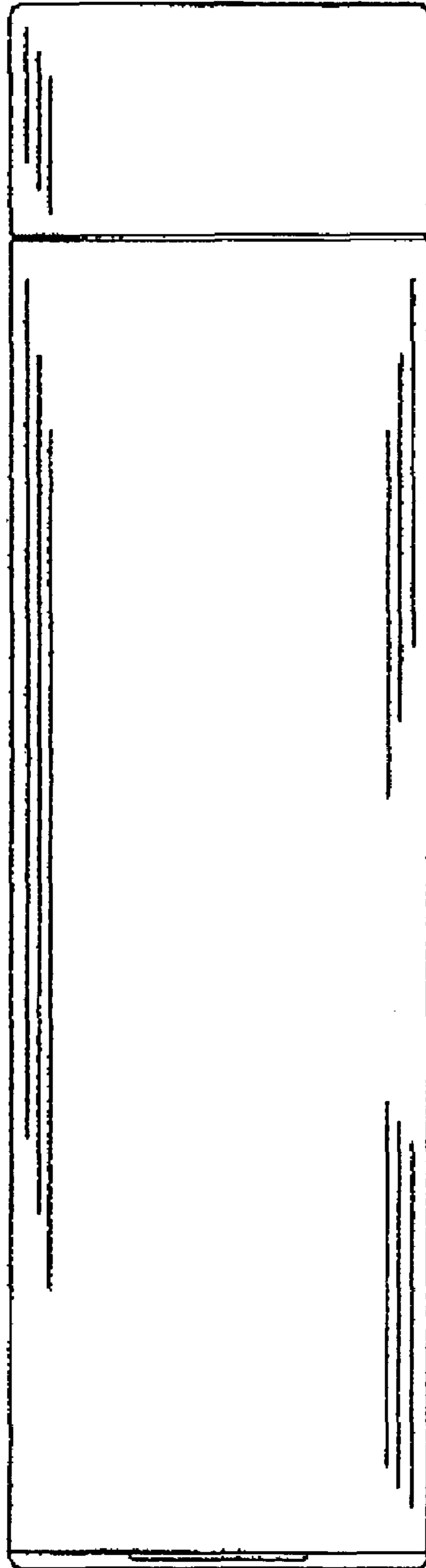

FIG. 3

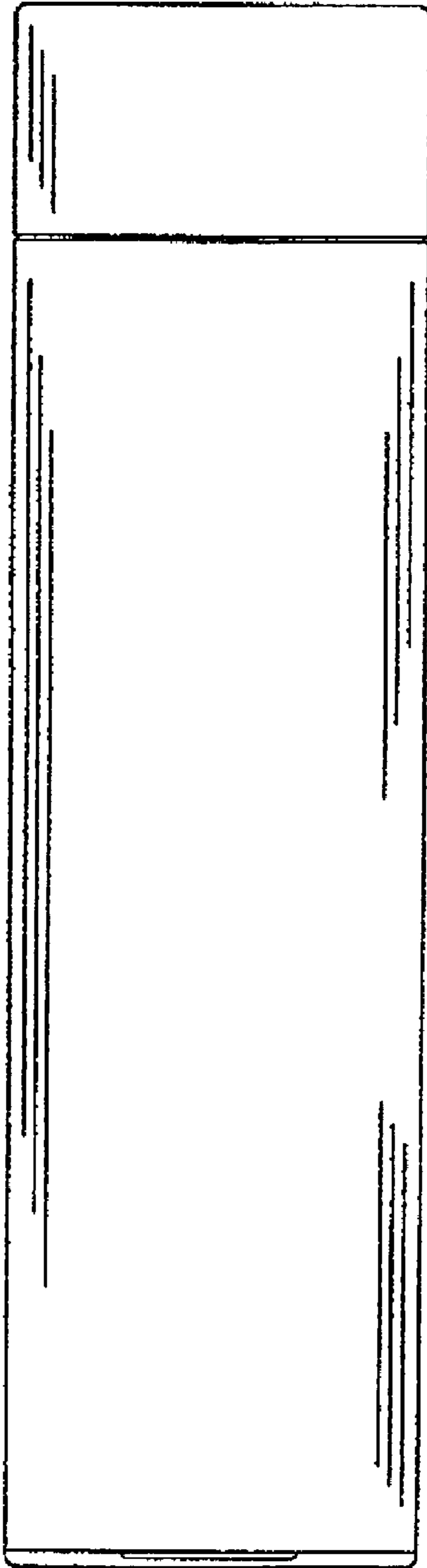

FIG. 4

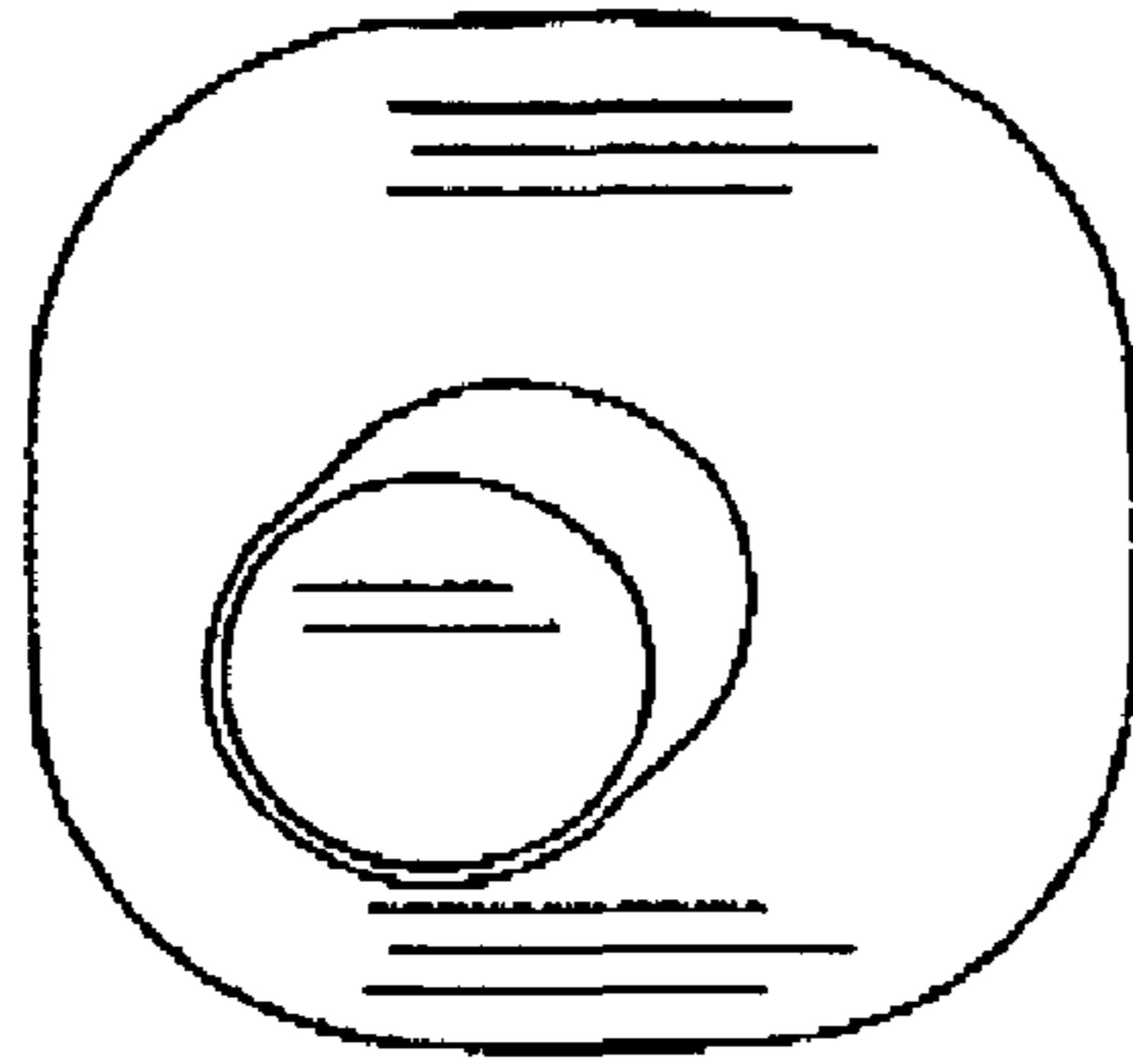

FIG. 5

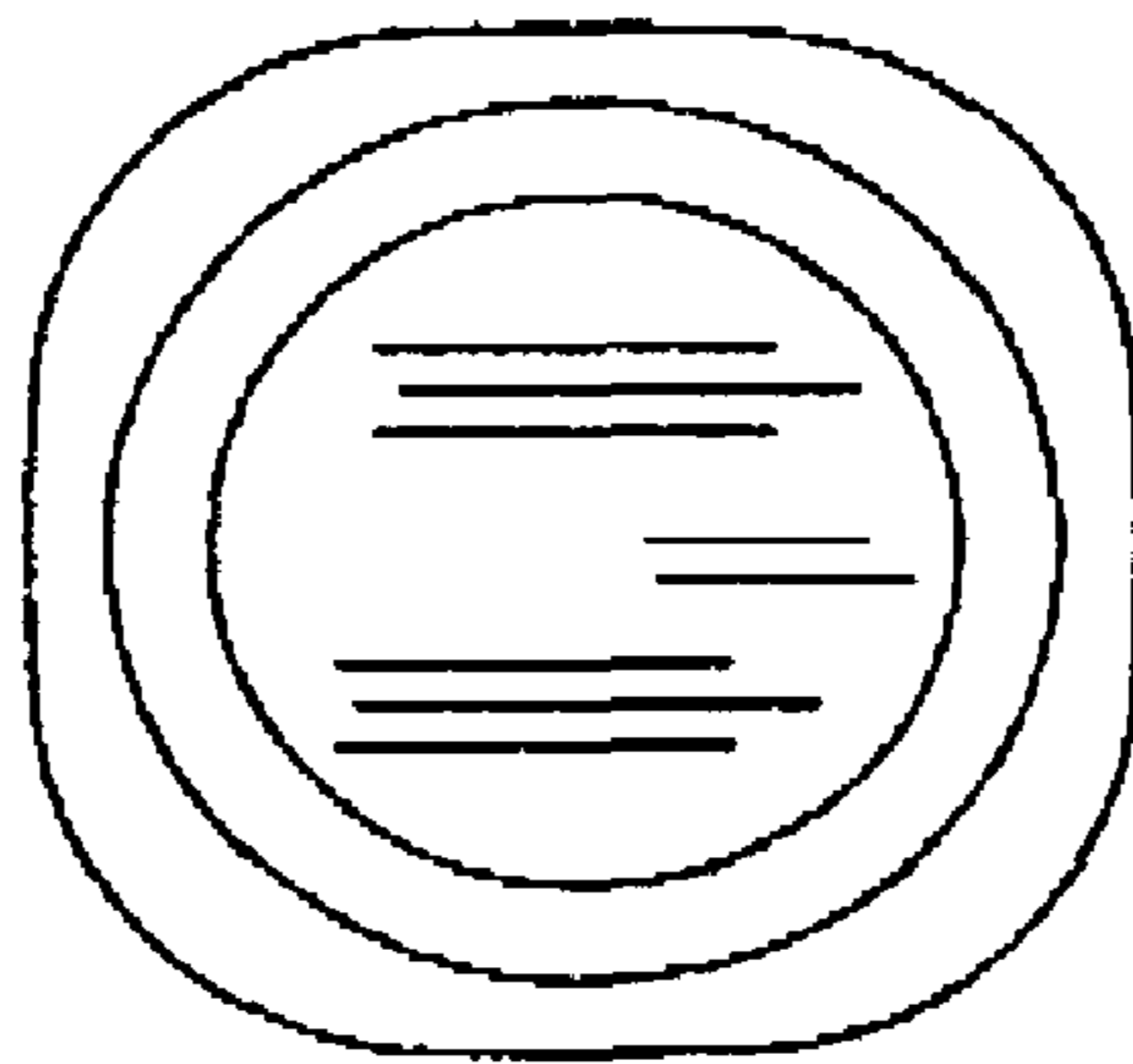

FIG. 6

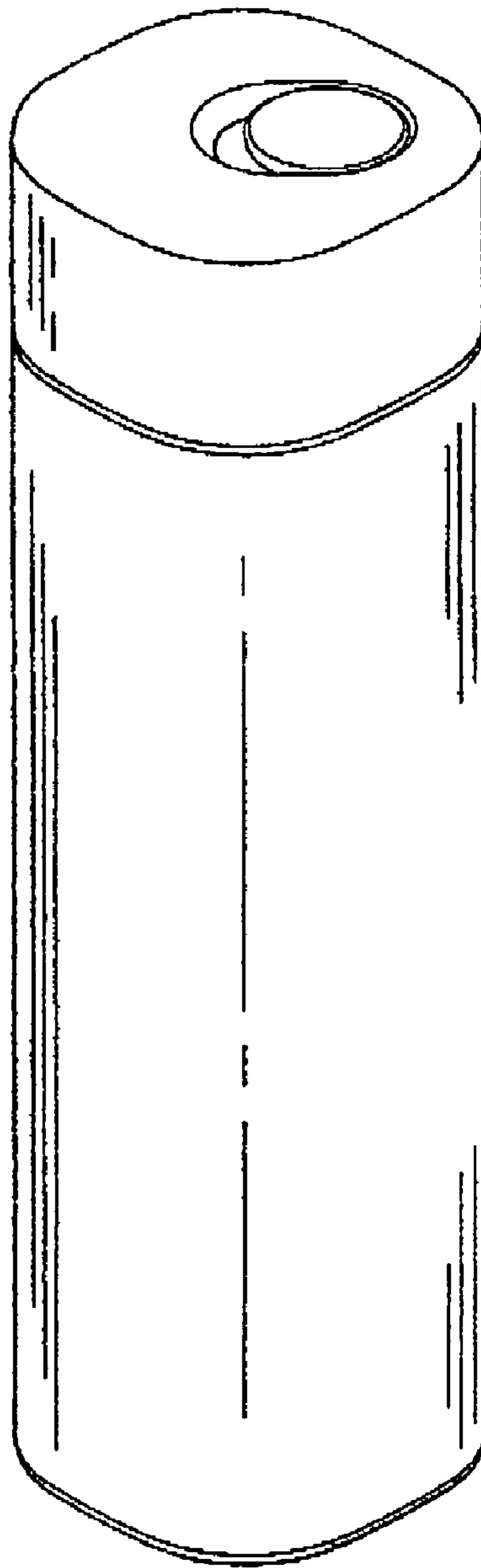

FIG. 7

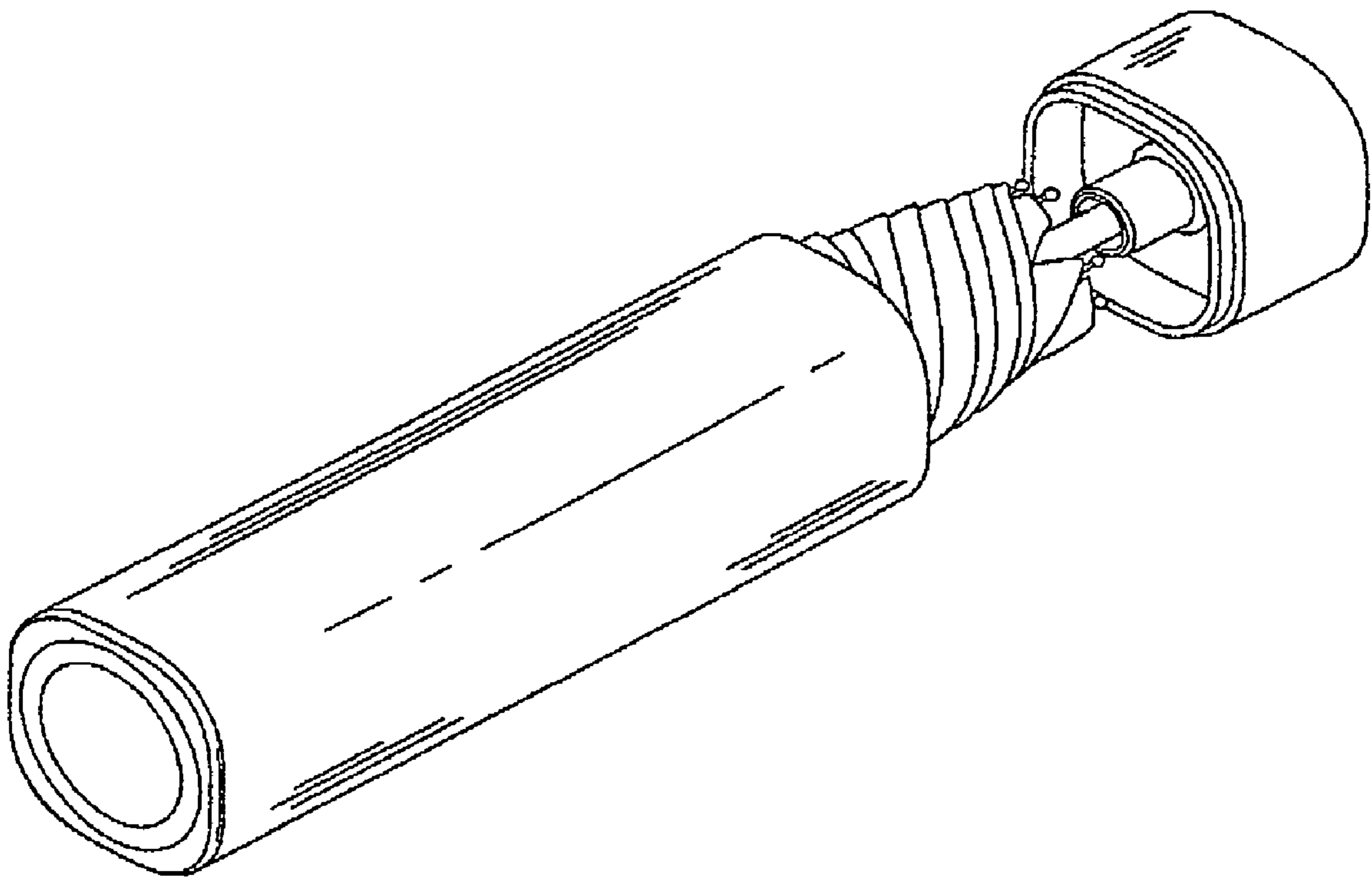

FIG. 8

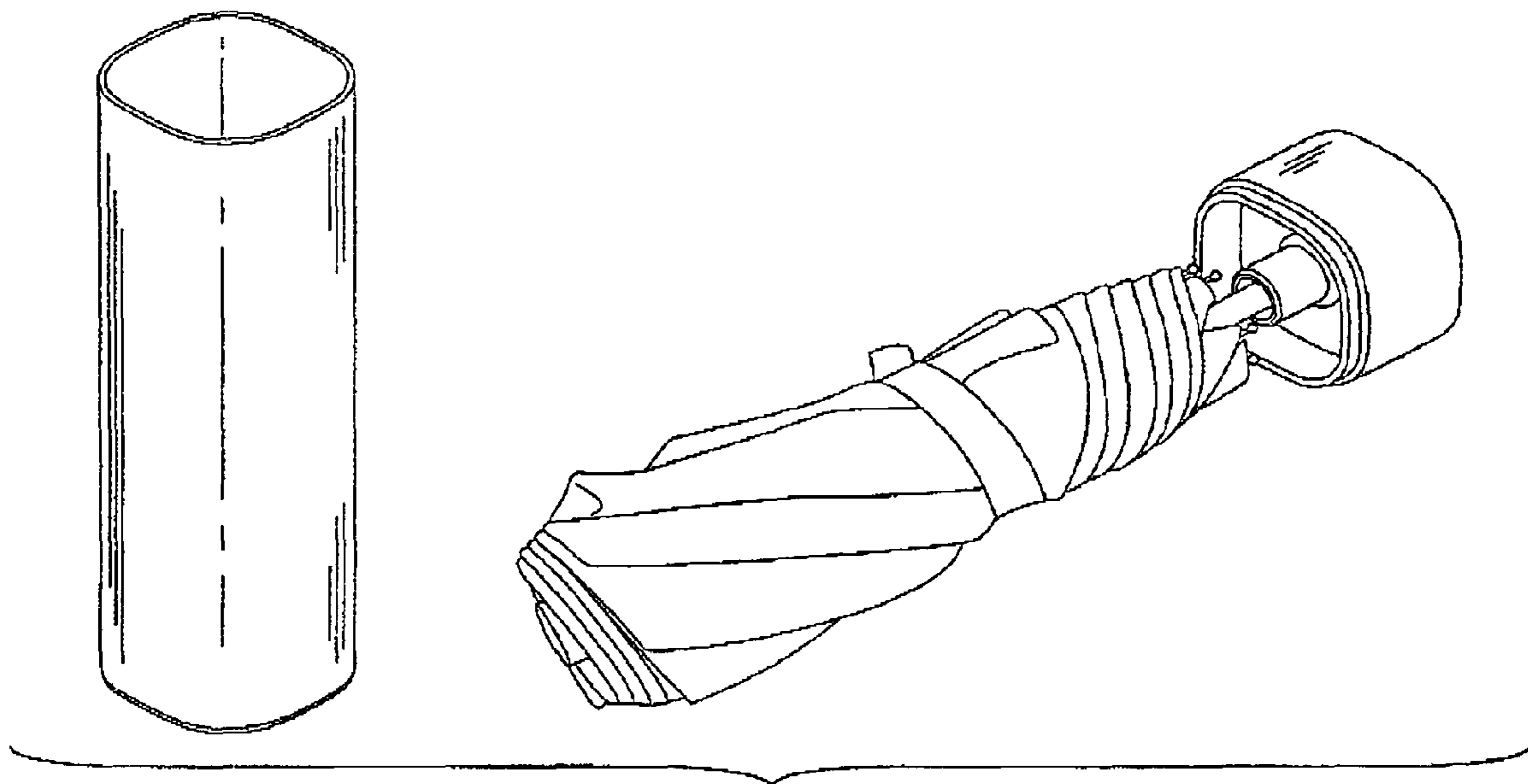

FIG. 9

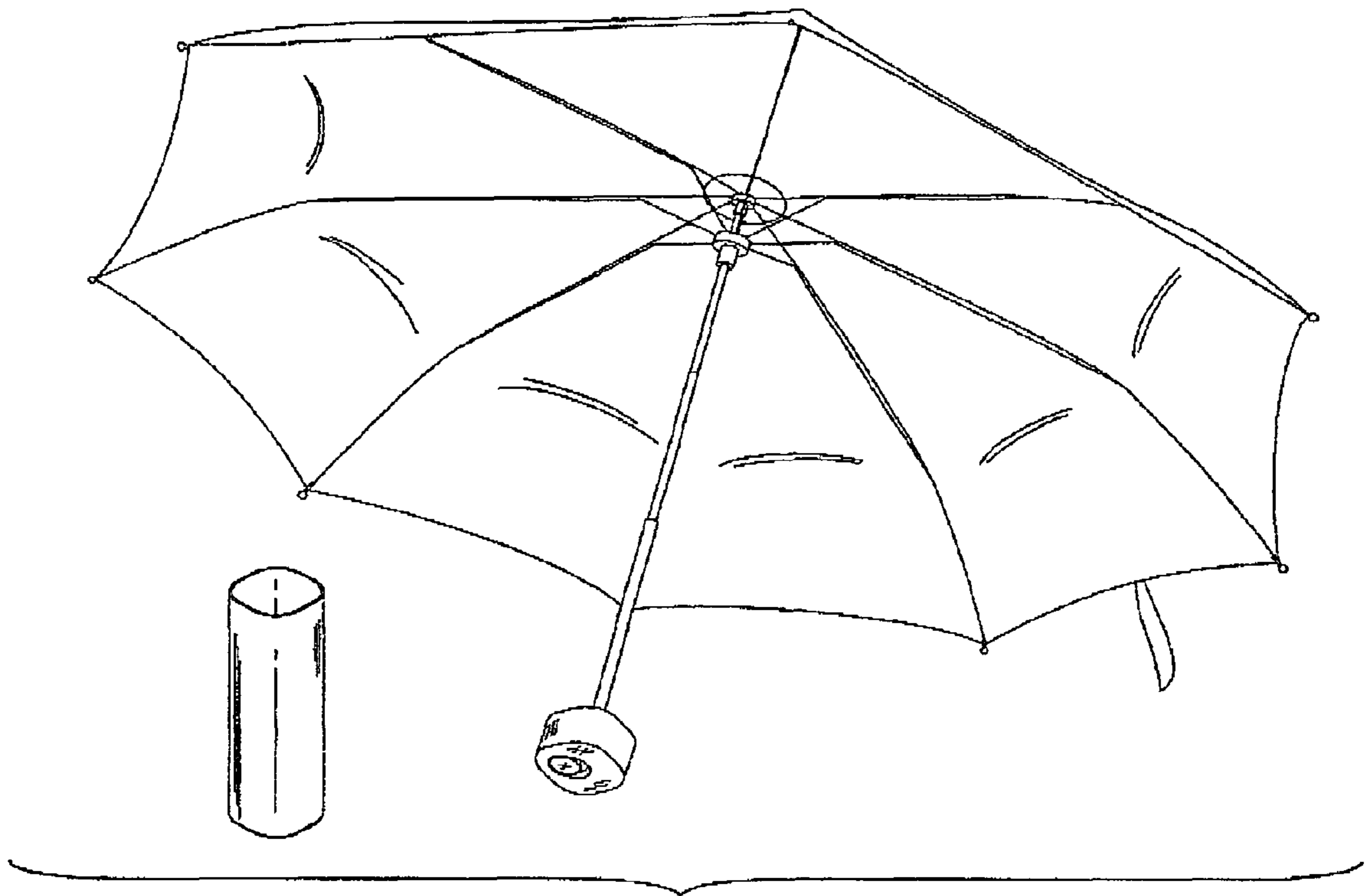

FIG. 10