



US00D624726S

(12) **United States Design Patent**  
**O'Regan et al.**

(10) **Patent No.:** **US D624,726 S**

(45) **Date of Patent:** **\*\* Oct. 5, 2010**

(54) **CHOCOLATE**

(75) Inventors: **John O'Regan**, Dublin (IE); **Gillian Ryan**, Dublin (IE)

(73) Assignee: **The Irish Chocolate Company**, Dublin (IE)

(\*\*) Term: **14 Years**

(21) Appl. No.: **29/333,147**

(22) Filed: **Mar. 4, 2009**

(30) **Foreign Application Priority Data**

Sep. 5, 2008 (EM) ..... 000997812-001  
Sep. 5, 2008 (EP) ..... 00076418-N

(51) **LOC (9) Cl.** ..... **01-01**

(52) **U.S. Cl.** ..... **D1/127**

(58) **Field of Classification Search** ..... D1/100,  
D1/101, 121, 127, 128, 130, 199; D21/386;  
D24/101, 104; D28/8.1; 426/76, 103, 122,  
426/144, 660, 512, 515

See application file for complete search history.

(56) **References Cited**

**U.S. PATENT DOCUMENTS**

D106,044 S \* 9/1937 Hirschhorn ..... D9/643  
D310,440 S \* 9/1990 Puglisi et al. .... D1/127  
D314,855 S \* 2/1991 Puglisi et al. .... D1/127  
D416,661 S \* 11/1999 Sherman et al. .... D1/127  
D556,427 S \* 12/2007 Kaiser et al. .... D1/127  
D578,729 S \* 10/2008 Lee et al. .... D1/127

\* cited by examiner

*Primary Examiner*—Cathron C Brooks

*Assistant Examiner*—Barbara Fox

(74) *Attorney, Agent, or Firm*—Porter, Wright, Morris & Arthur, LLP

(57) **CLAIM**

The ornamental design for a chocolate, as shown and described.

**DESCRIPTION**

FIG. 1 is a front-top perspective view of a chocolate according to our new design;

FIG. 2 is a top plan view of the chocolate according to our new design;

FIG. 3 is a front elevational view of the chocolate according to our new design;

FIG. 4 is a rear elevational view of the chocolate according to our new design;

FIG. 5 is a right side elevational view of the chocolate according to our new design;

FIG. 6 is a left side elevational view of the chocolate according to our new design;

FIG. 7 is a bottom plan view of the chocolate according to our new design;

FIG. 8 is a rear-top perspective view of the chocolate according to our new design;

FIG. 9 is a right-top perspective view of the chocolate according to our new design; and,

FIG. 10 is a left-top perspective view of the chocolate according to our new design.

**1 Claim, 10 Drawing Sheets**

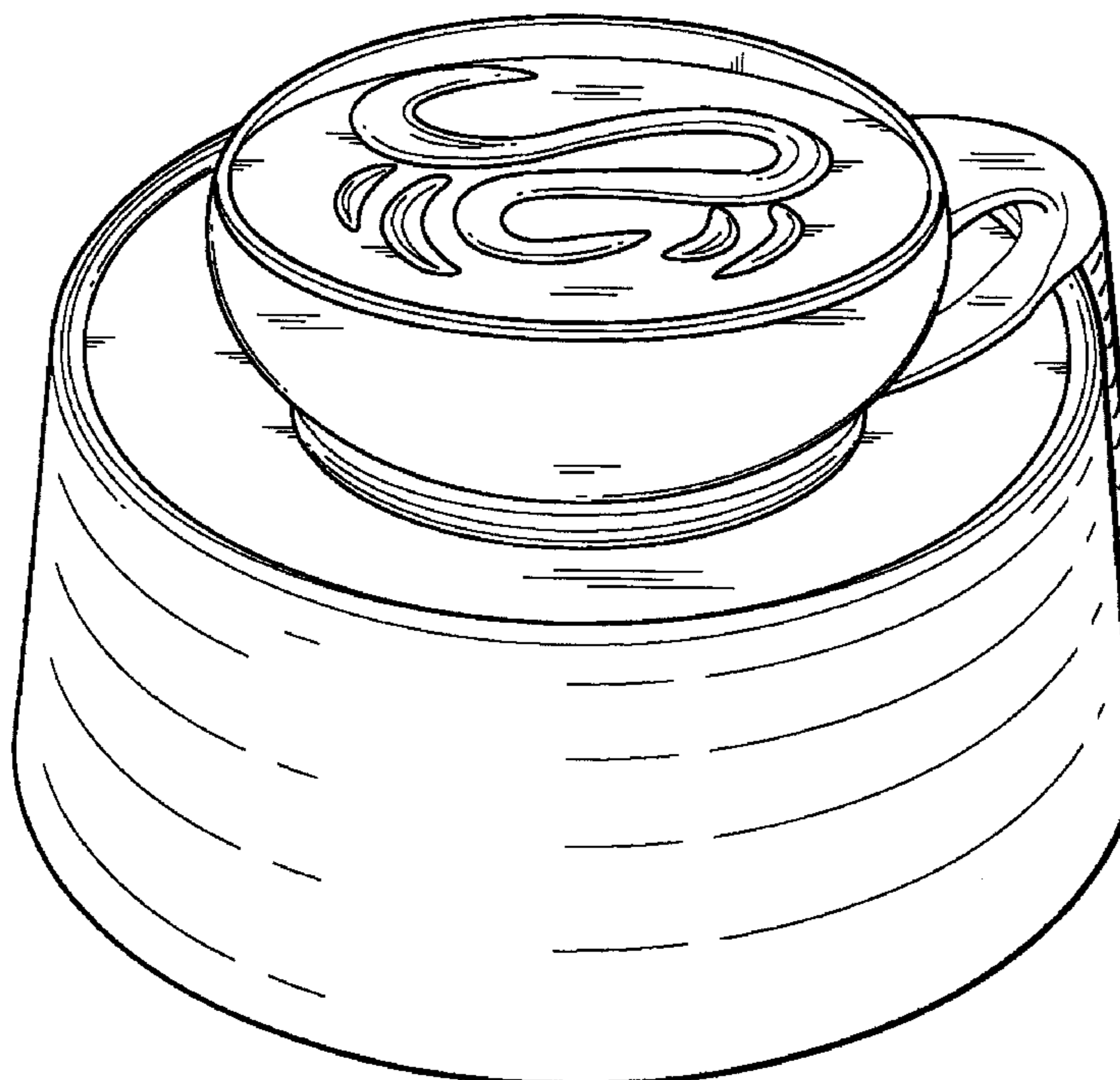

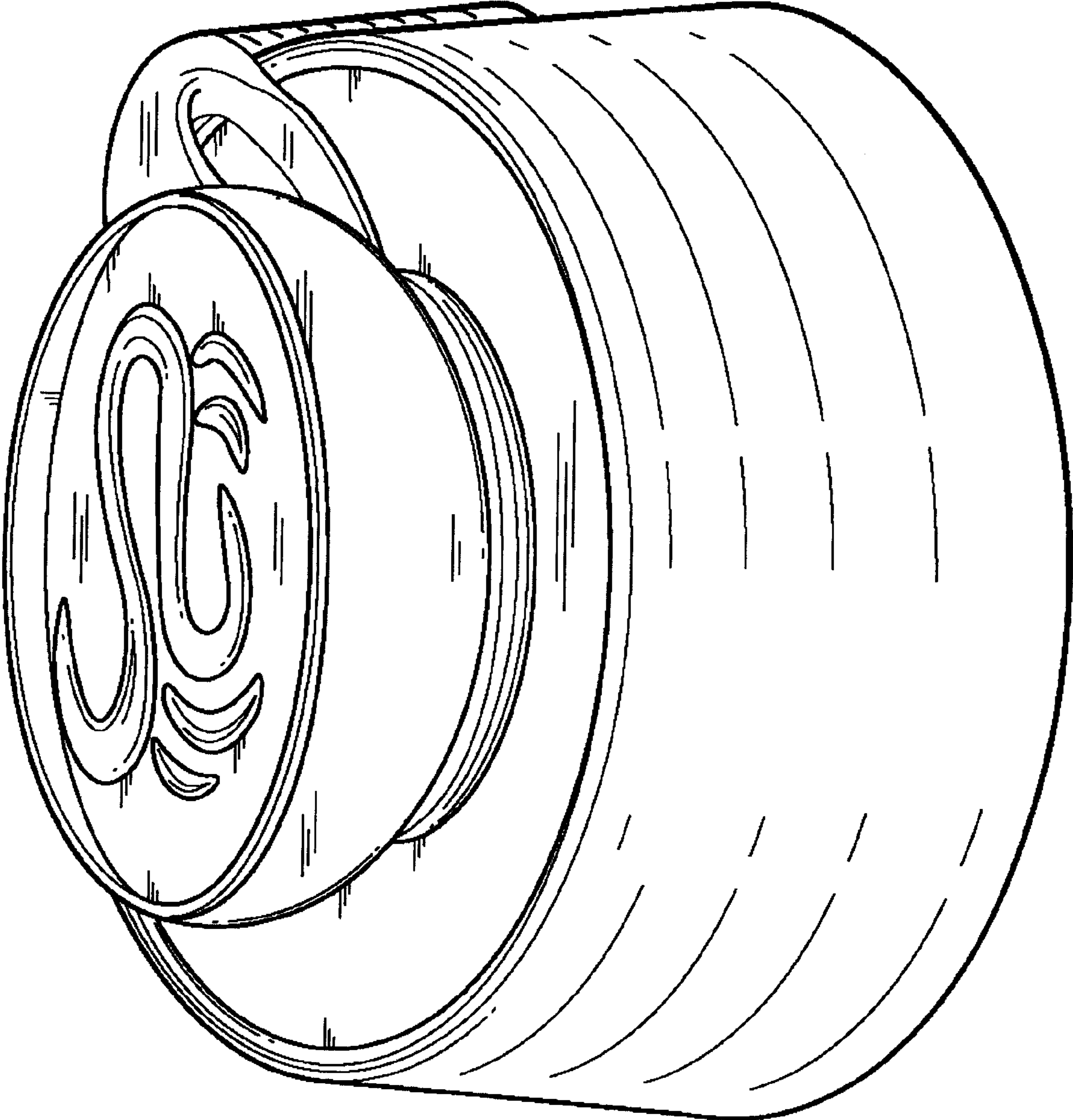

FIG. 1

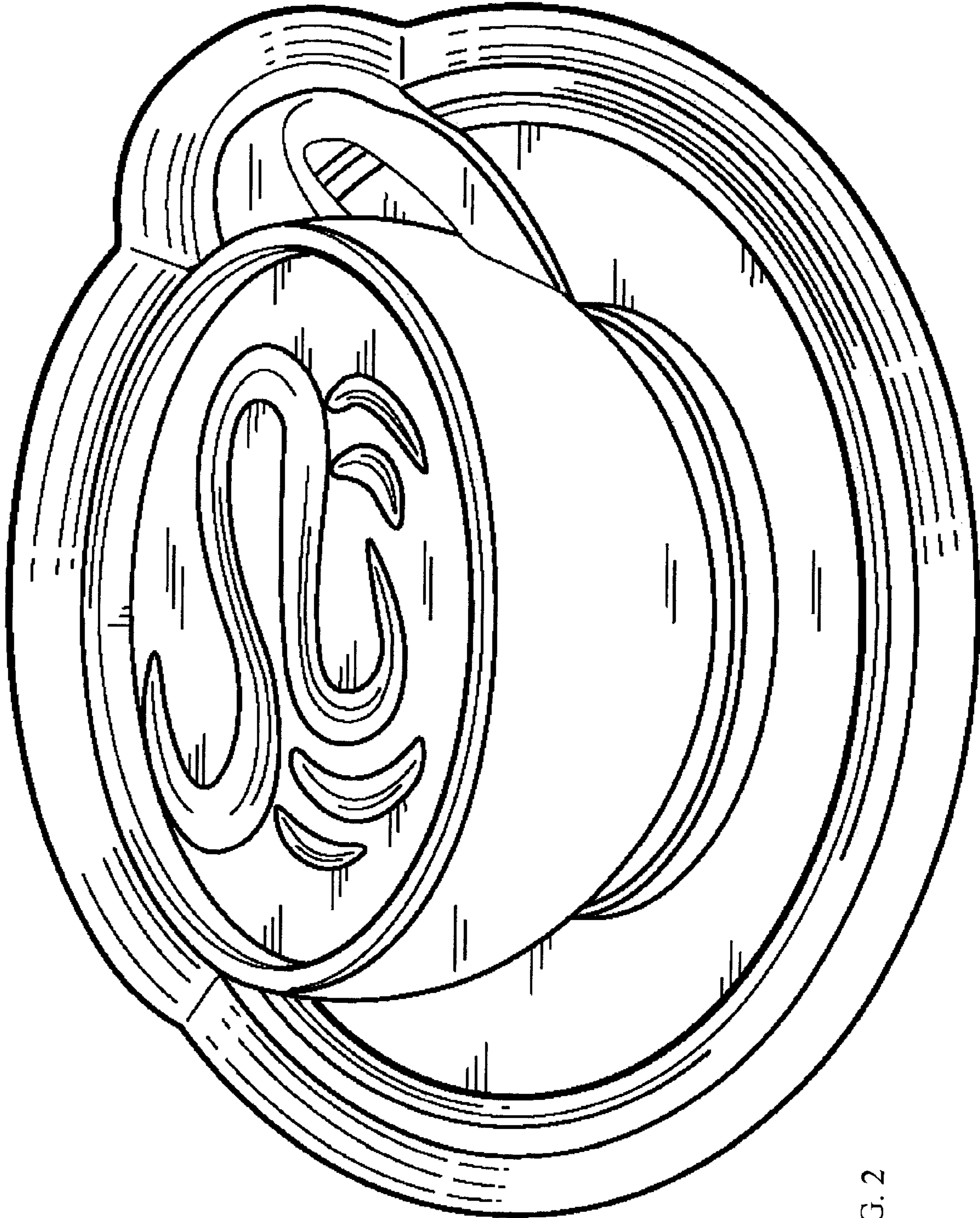

FIG. 2

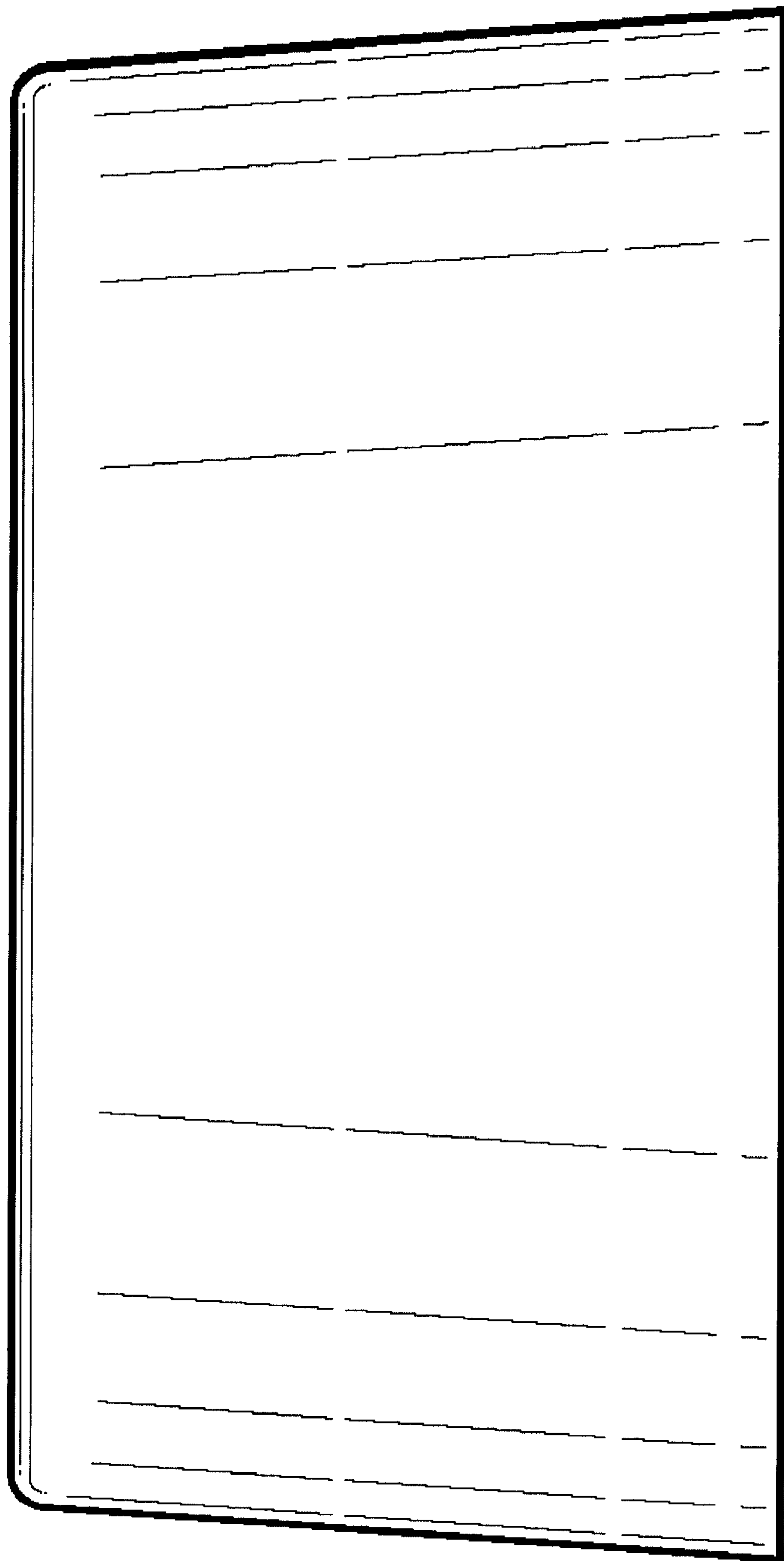

FIG. 3



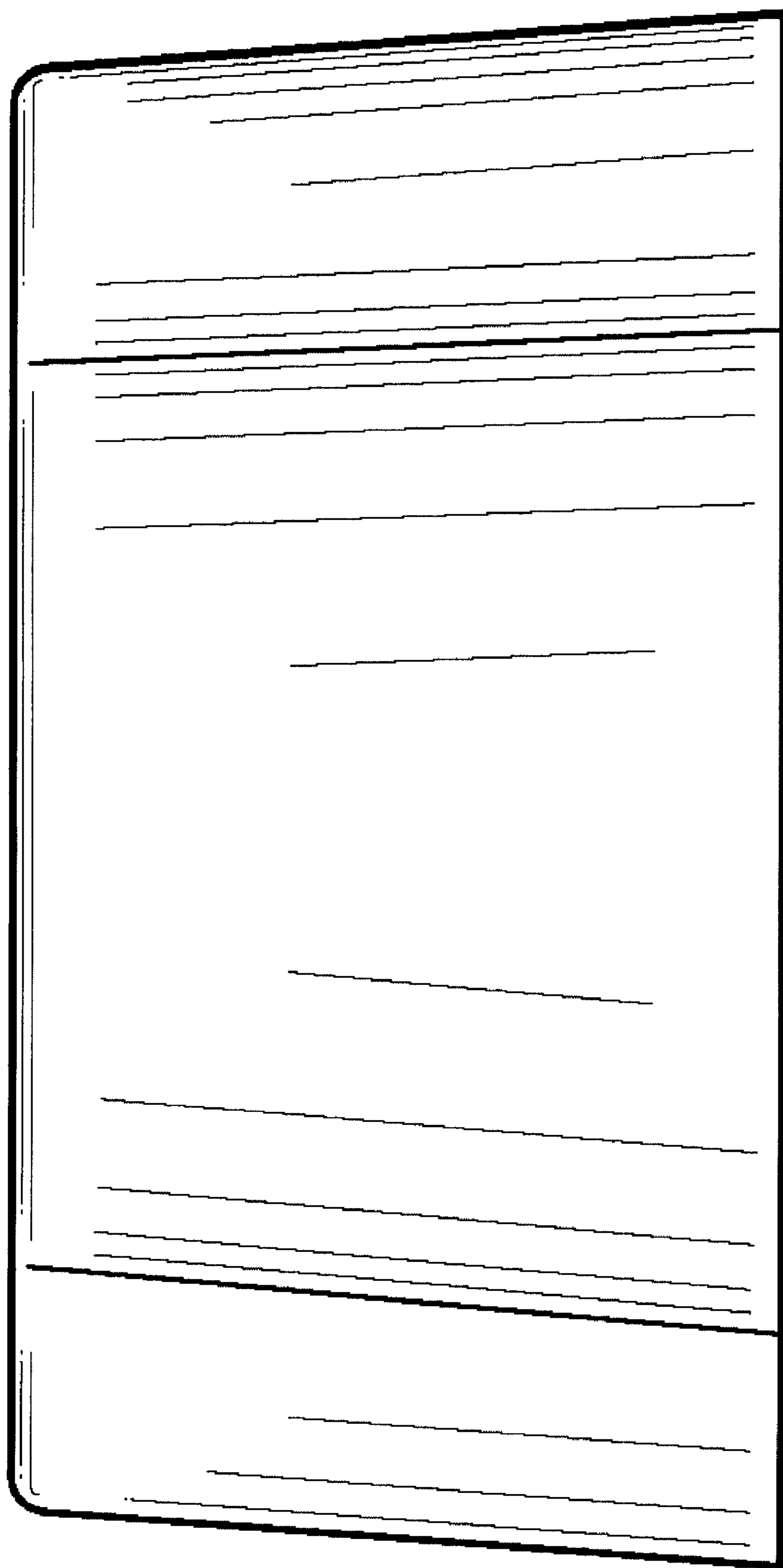

FIG. 4

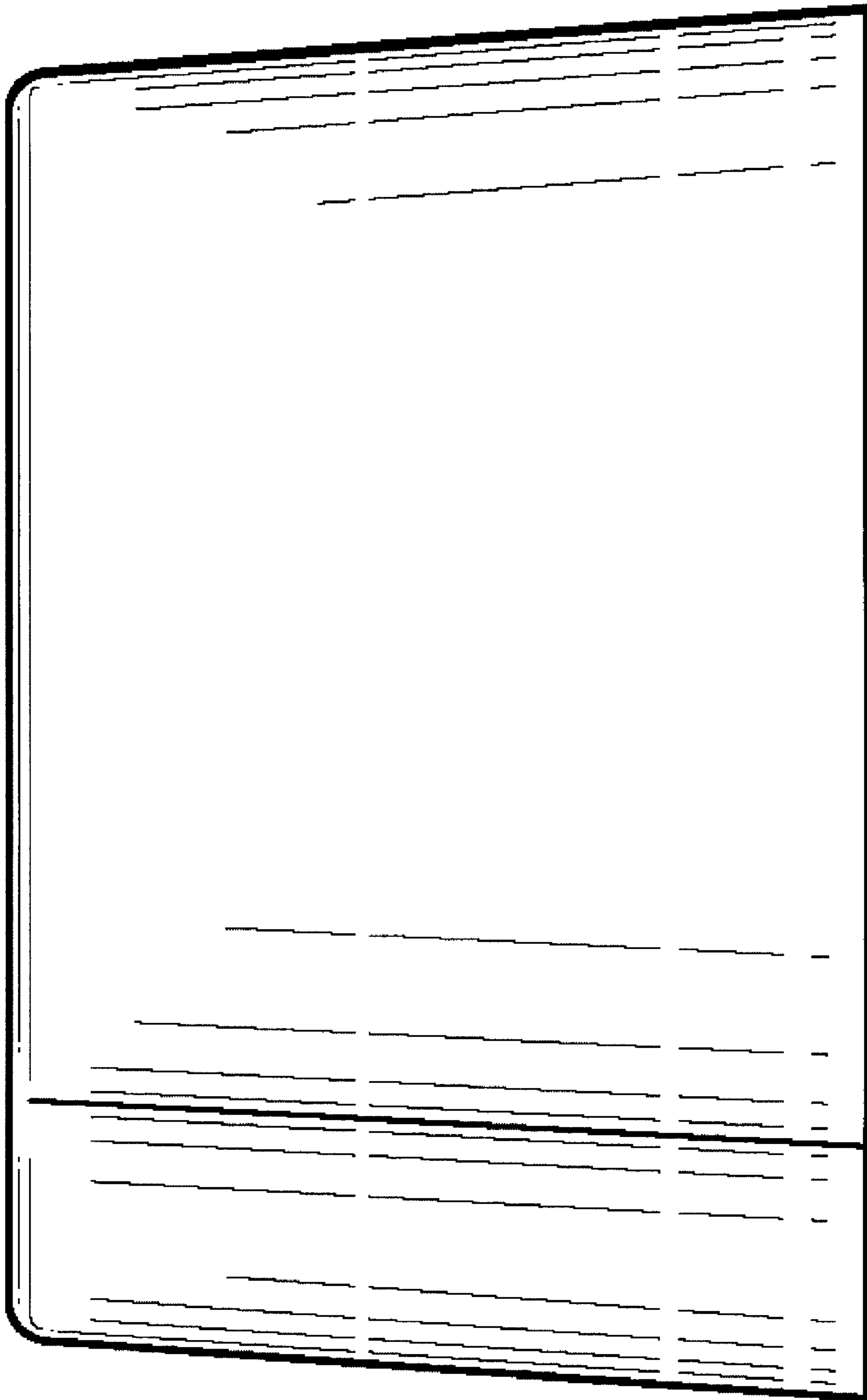

FIG. 5

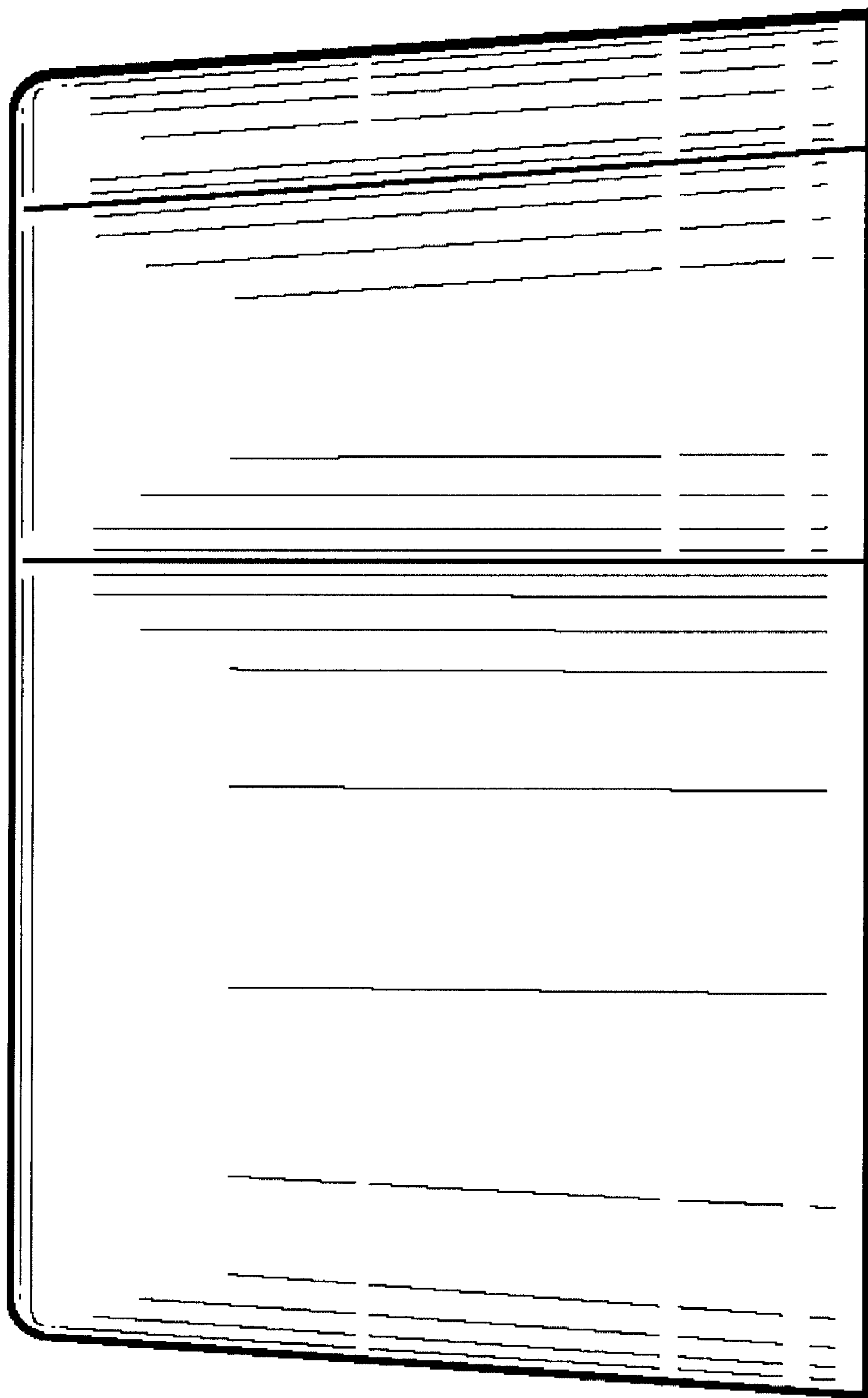

FIG. 6

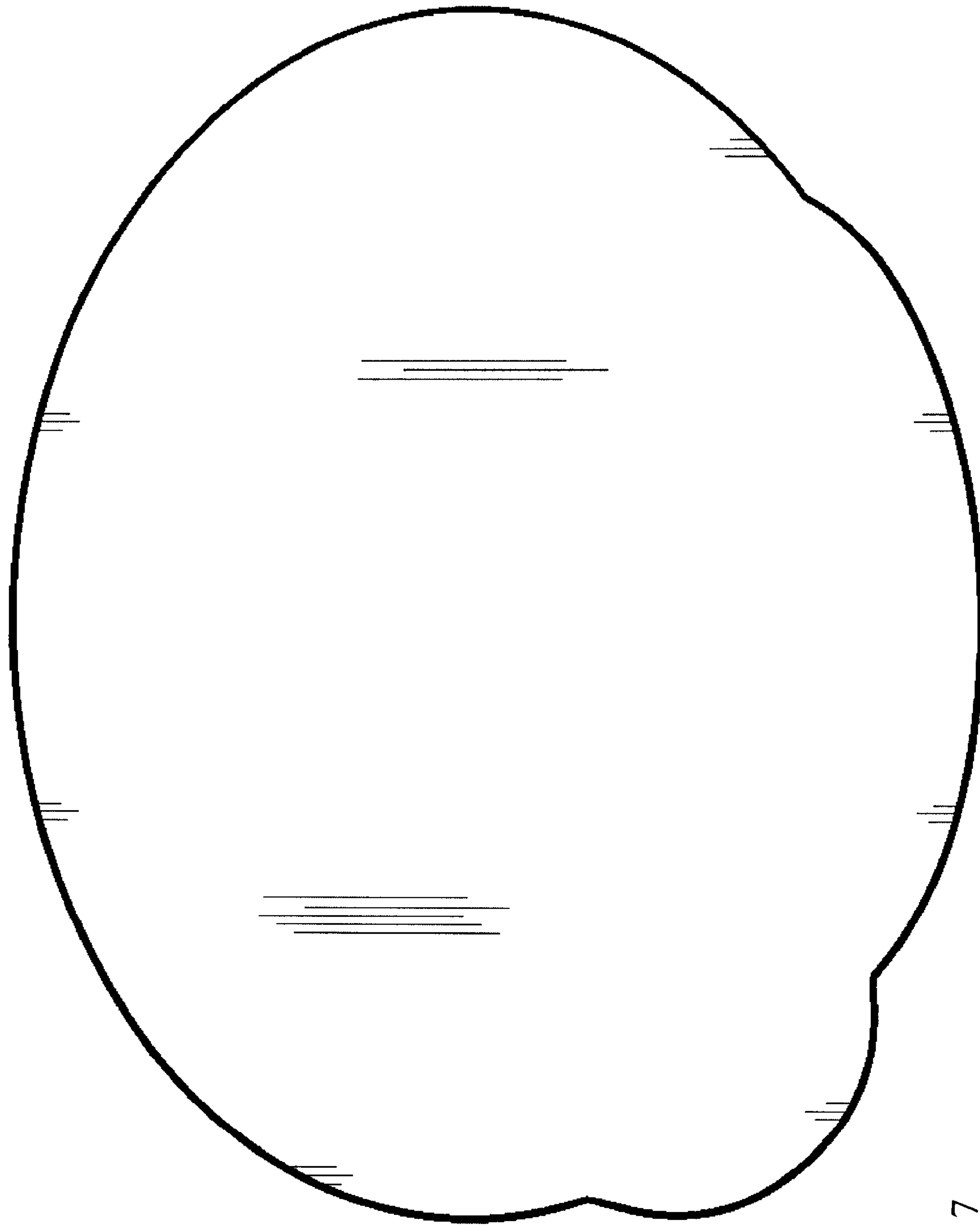

FIG. 7



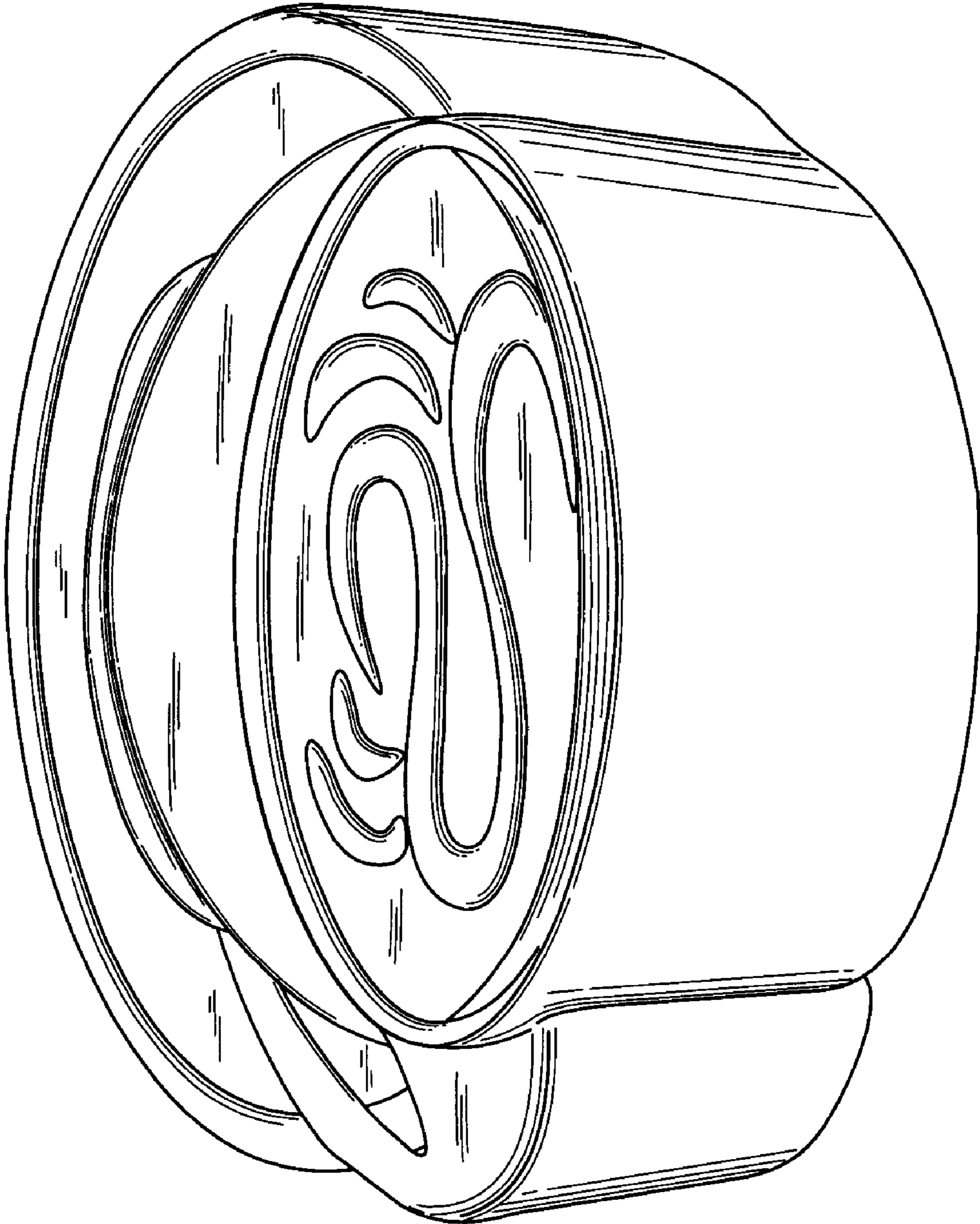

FIG. 8

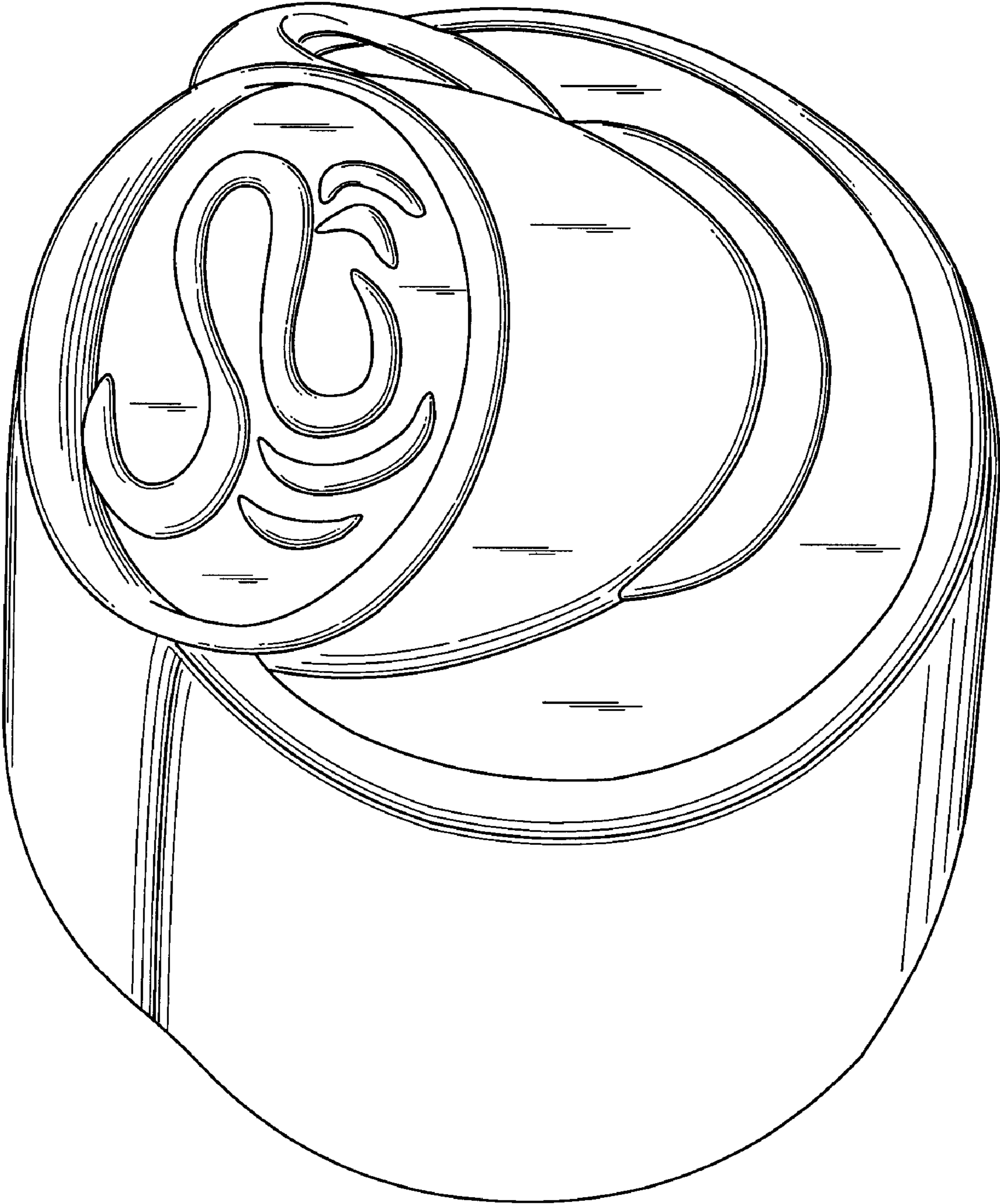

FIG. 9

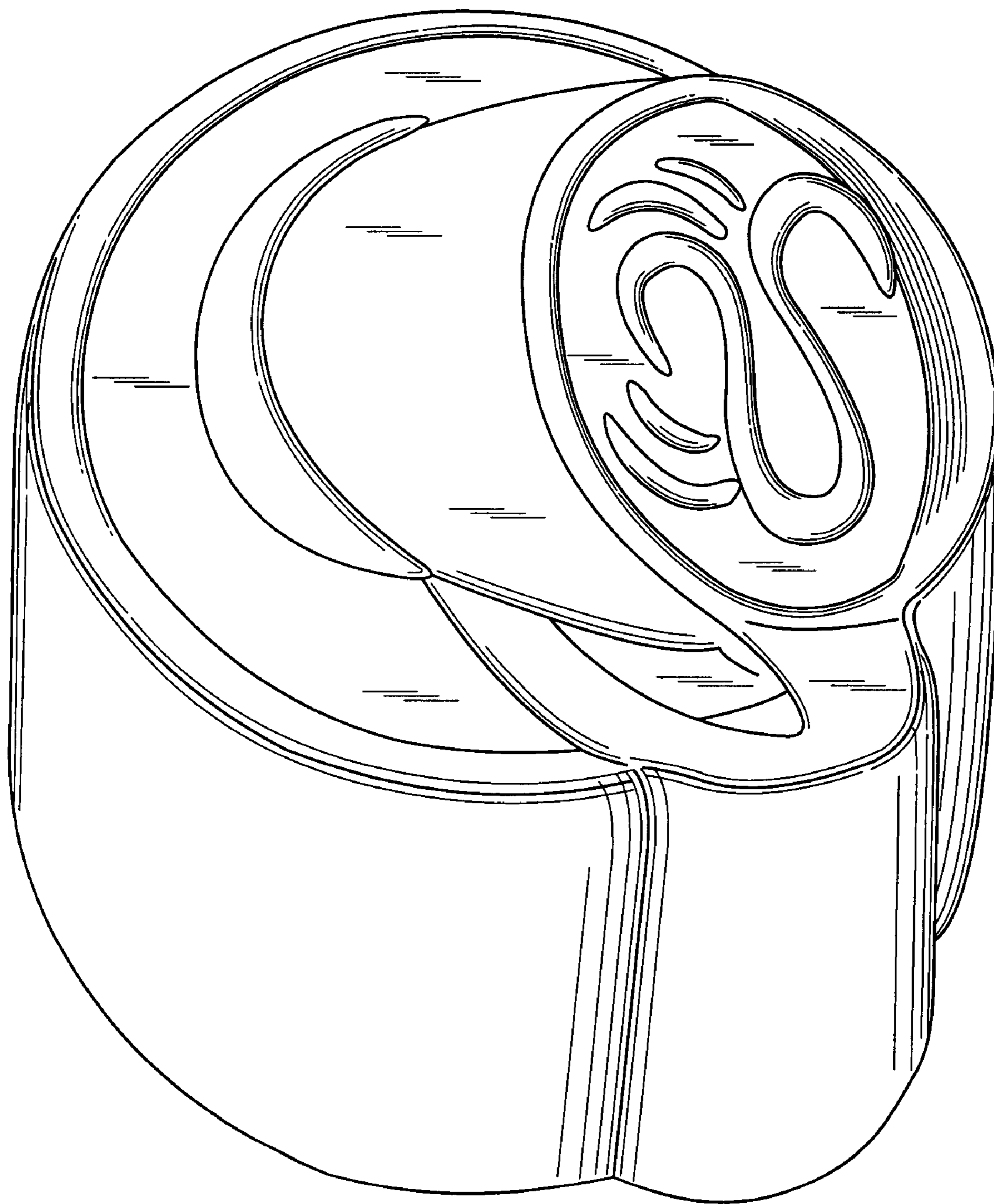

FIG. 10