



US00D624722S

(12) **United States Design Patent**  
**Wilkerson et al.**

(10) **Patent No.:** **US D624,722 S**

(45) **Date of Patent:** **\*\* Sep. 28, 2010**

(54) **TRASH RECEPTACLE**

(75) Inventors: **Jack Randal Wilkerson**, Umatilla, FL (US); **Robert D. Bailey**, Long Beach, CA (US); **Betty Yang**, Santa Monica, CA (US); **A. Michael Sullivan**, St. Louis, MO (US)

(73) Assignee: **IPS Industries, Inc.**, Cerritos, CA (US)

(\*\*) Term: **14 Years**

(21) Appl. No.: **29/351,202**

(22) Filed: **Dec. 2, 2009**

(51) **LOC (9) Cl.** ..... **09-09**

(52) **U.S. Cl.** ..... **D34/4**

(58) **Field of Classification Search** ..... D34/1, D34/4, 7, 10, 11; D7/604, 606, 625; D9/441, D9/451, 435; D11/133, 172, 184; 220/908  
See application file for complete search history.

(56) **References Cited**

U.S. PATENT DOCUMENTS

D327,817 S \* 7/1992 Paullin ..... D7/515

(Continued)

*Primary Examiner*—Cynthia E Ramirez

(74) *Attorney, Agent, or Firm*—Law Office of Steven R. Olsen, PLLC; Steven R. Olsen

(57) **CLAIM**

The ornamental design for a trash receptacle, as shown and described.

**DESCRIPTION**

FIG. 1 is a front elevation view of a trash receptacle showing a first embodiment of our new design;

FIG. 2 is a rear elevation view of a trash receptacle showing the first embodiment of our new design;

FIG. 3 is a left side elevation view of a trash receptacle showing the first embodiment and a third embodiment of our new design, a right side elevation view of the trash receptacle according to the first embodiment and the third embodiment being a mirror image thereof;

FIG. 4 is a top view of a trash receptacle showing the first embodiment and a second embodiment of our new design;

FIG. 5 is a bottom view of a trash receptacle showing the first embodiment of our new design;

FIG. 6 is a front elevation view of a trash receptacle showing the second embodiment of our new design;

FIG. 7 is a rear elevation view of a trash receptacle showing the second embodiment of our new design;

FIG. 8 is a left side elevation view of a trash receptacle showing the second embodiment and a fourth embodiment of our new design, a right side elevation view of the trash receptacle according to the second embodiment and the fourth embodiment being a mirror image thereof;

FIG. 9 is a bottom view of a trash receptacle showing the second embodiment of our new design;

FIG. 10 is a front elevation view of a trash receptacle showing the third embodiment of our new design;

FIG. 11 is a rear elevation view of a trash receptacle showing the third embodiment of our new design;

FIG. 12 is a top view of a trash receptacle showing the third embodiment and the fourth embodiment of our new design;

FIG. 13 is a bottom view of a trash receptacle showing the third embodiment of our new design;

FIG. 14 is a front elevation view of a trash receptacle showing the fourth embodiment of our new design;

FIG. 15 is a rear elevation view of a trash receptacle showing the fourth embodiment of our new design; and,

FIG. 16 is a bottom view of a trash receptacle showing the fourth embodiment of our new design.

**1 Claim, 5 Drawing Sheets**

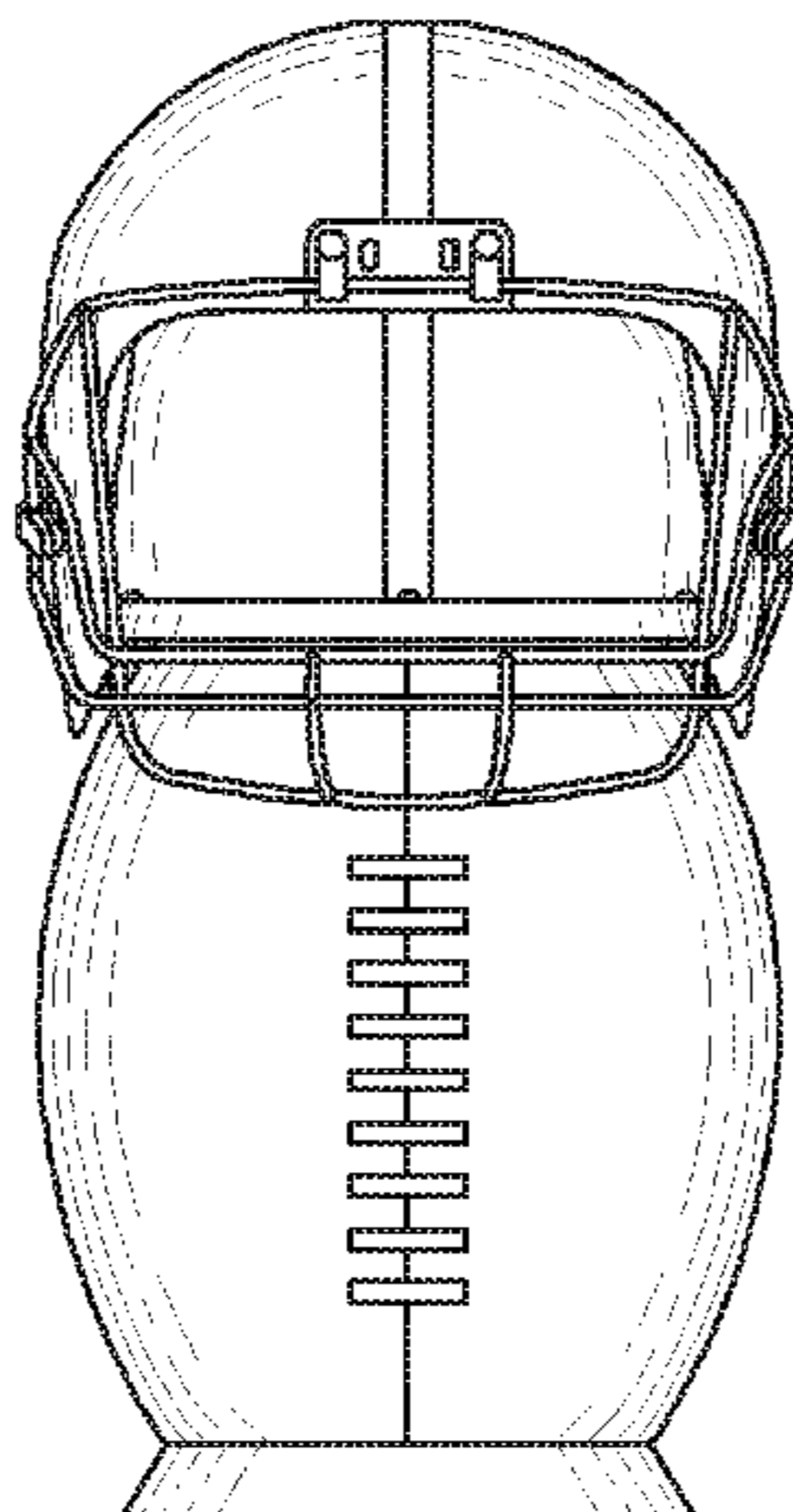

# US D624,722 S

Page 2

---

## U.S. PATENT DOCUMENTS

D354,642 S *	1/1995	Stoddard et al. ....	D6/450	D562,073 S *	2/2008	Yeh .....	D7/515
D425,757 S *	5/2000	Printz et al. ....	D7/510	D586,063 S	2/2009	Wolford et al.	
D452,120 S *	12/2001	Brangle et al. ....	D7/606	D595,467 S	6/2009	Wolford et al.	
D507,181 S *	7/2005	Malik .....	D9/451	D596,363 S	7/2009	Wolford et al.	
D511,212 S *	11/2005	Whalen .....	D24/197	D596,462 S *	7/2009	Serruya et al. ....	D7/515
D532,172 S	11/2006	Gianfrisco		D602,223 S	10/2009	Stegeby	
D541,111 S *	4/2007	Morgan et al. ....	D7/625	D609,111 S *	2/2010	Bentley et al. ....	D9/668
				D616,169 S *	5/2010	Wolford et al. ....	D34/4

\* cited by examiner

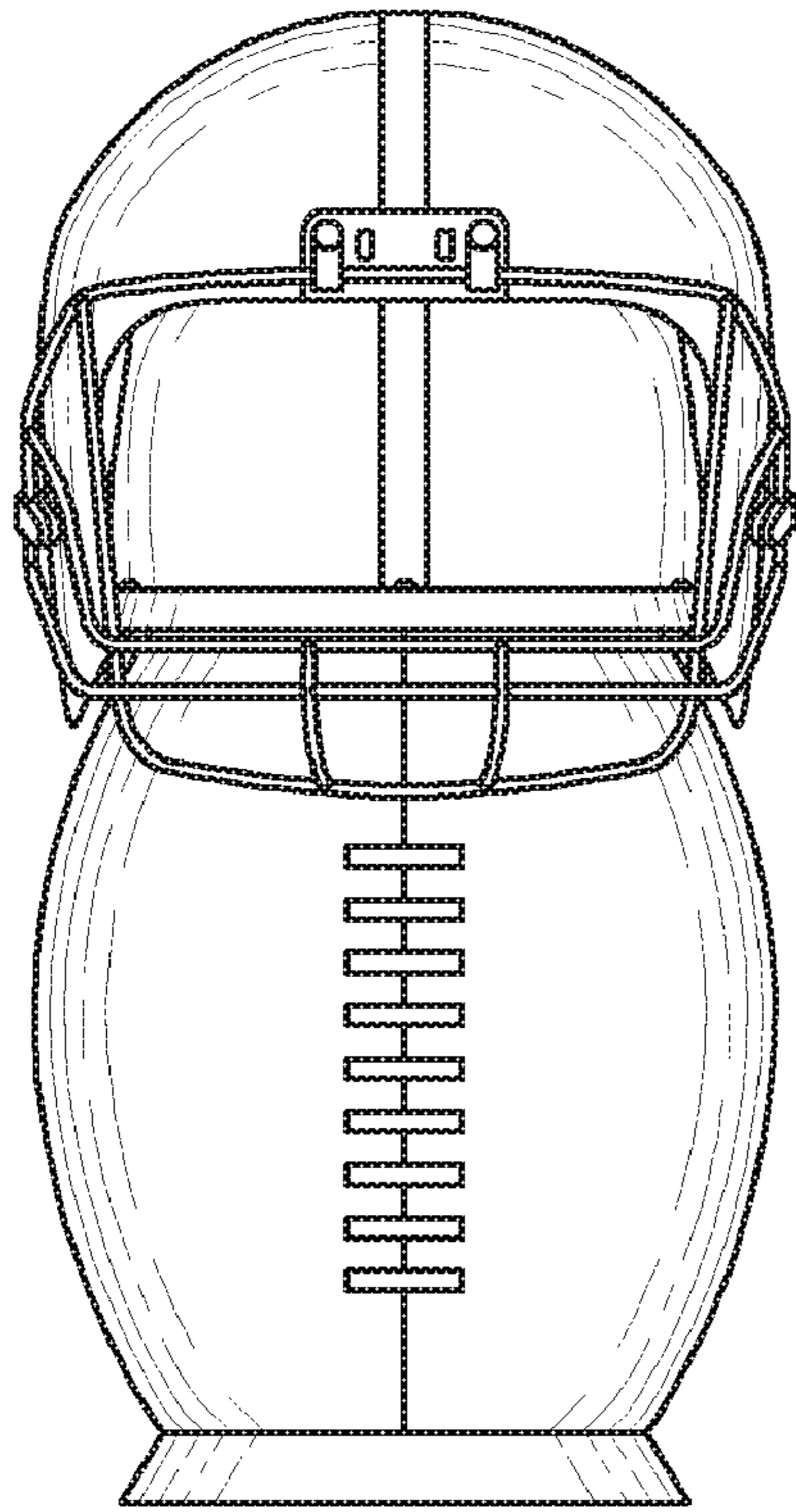

FIG. 1

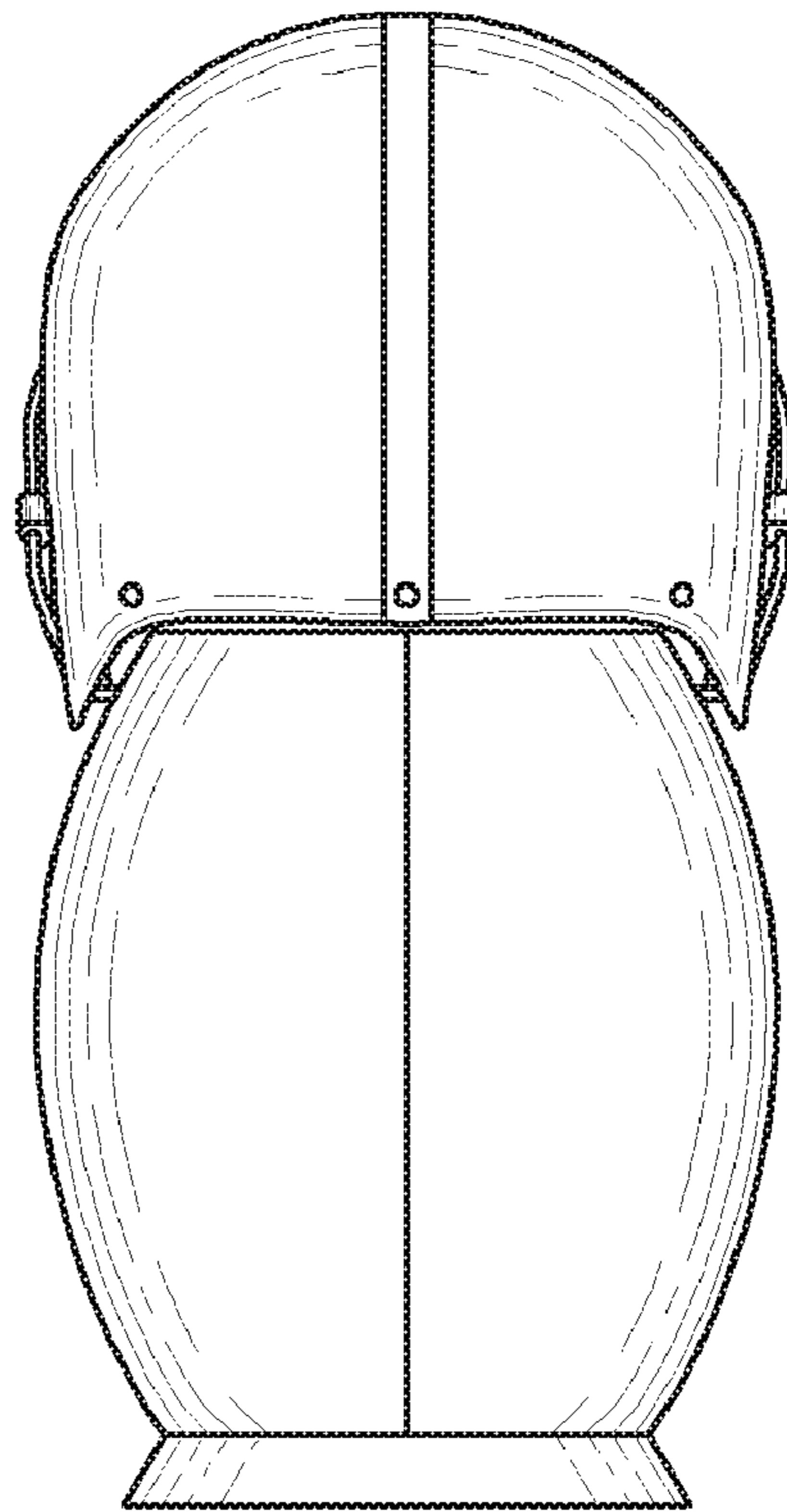

FIG. 2

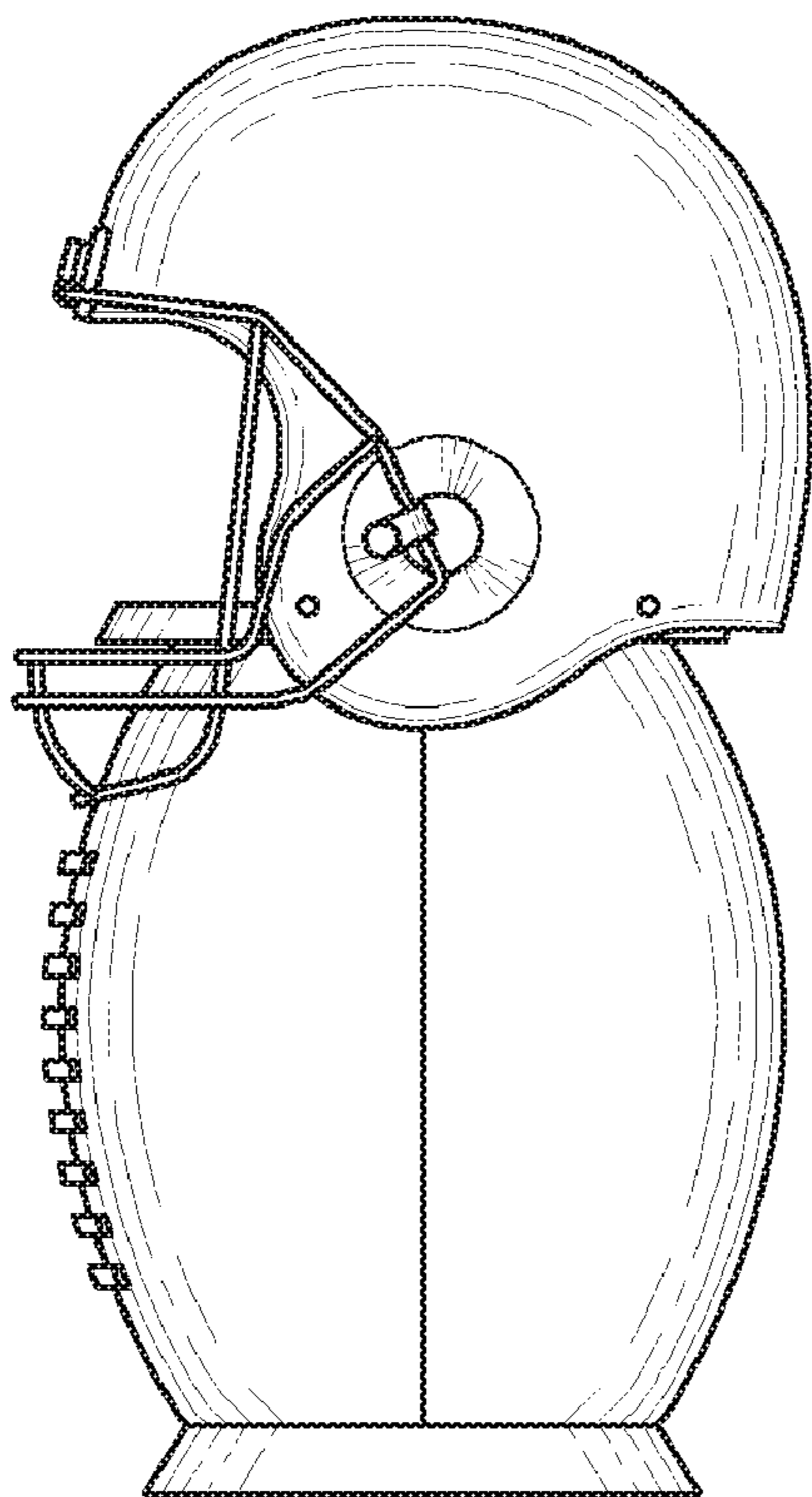

FIG. 3

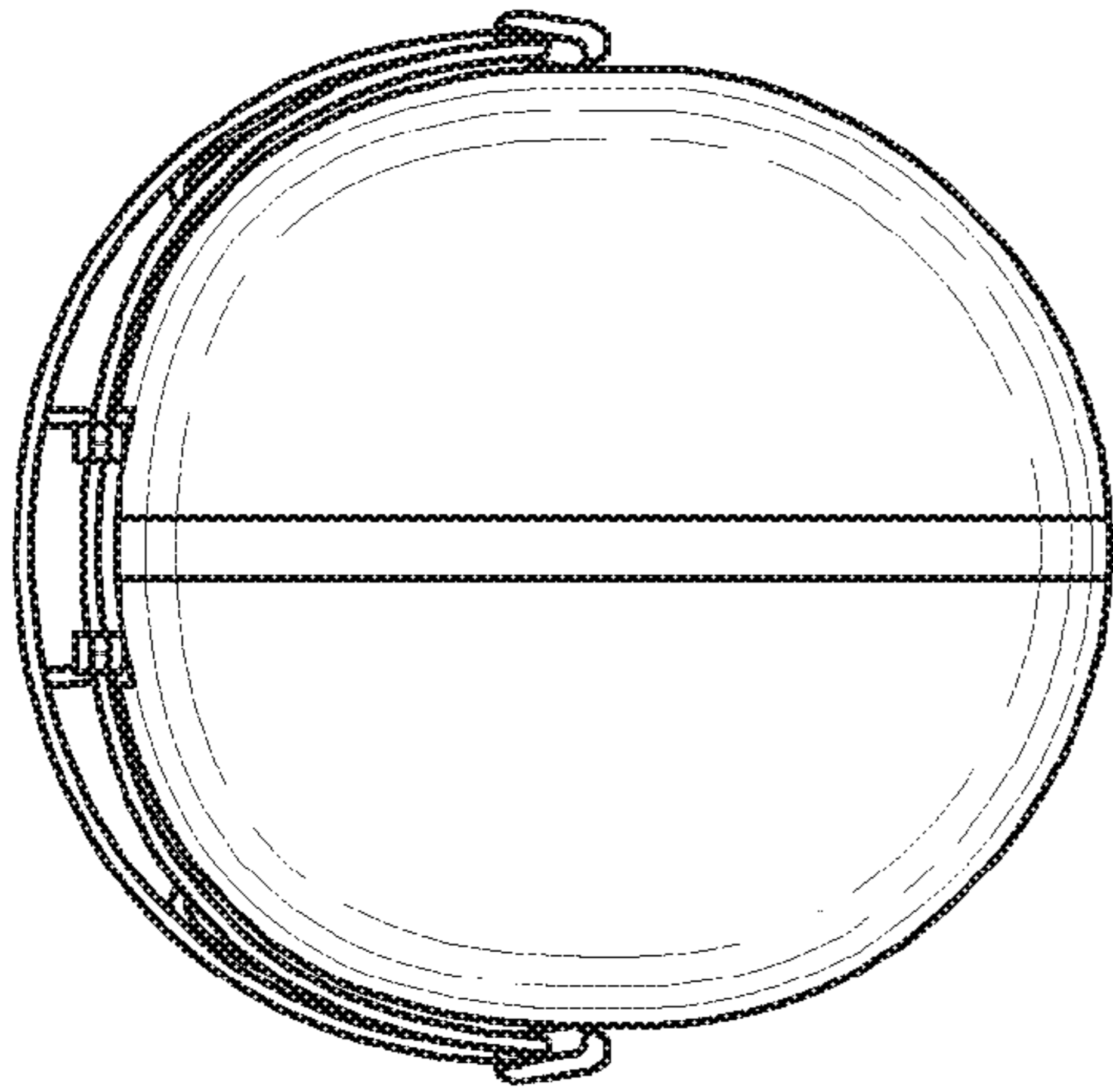

FIG. 4

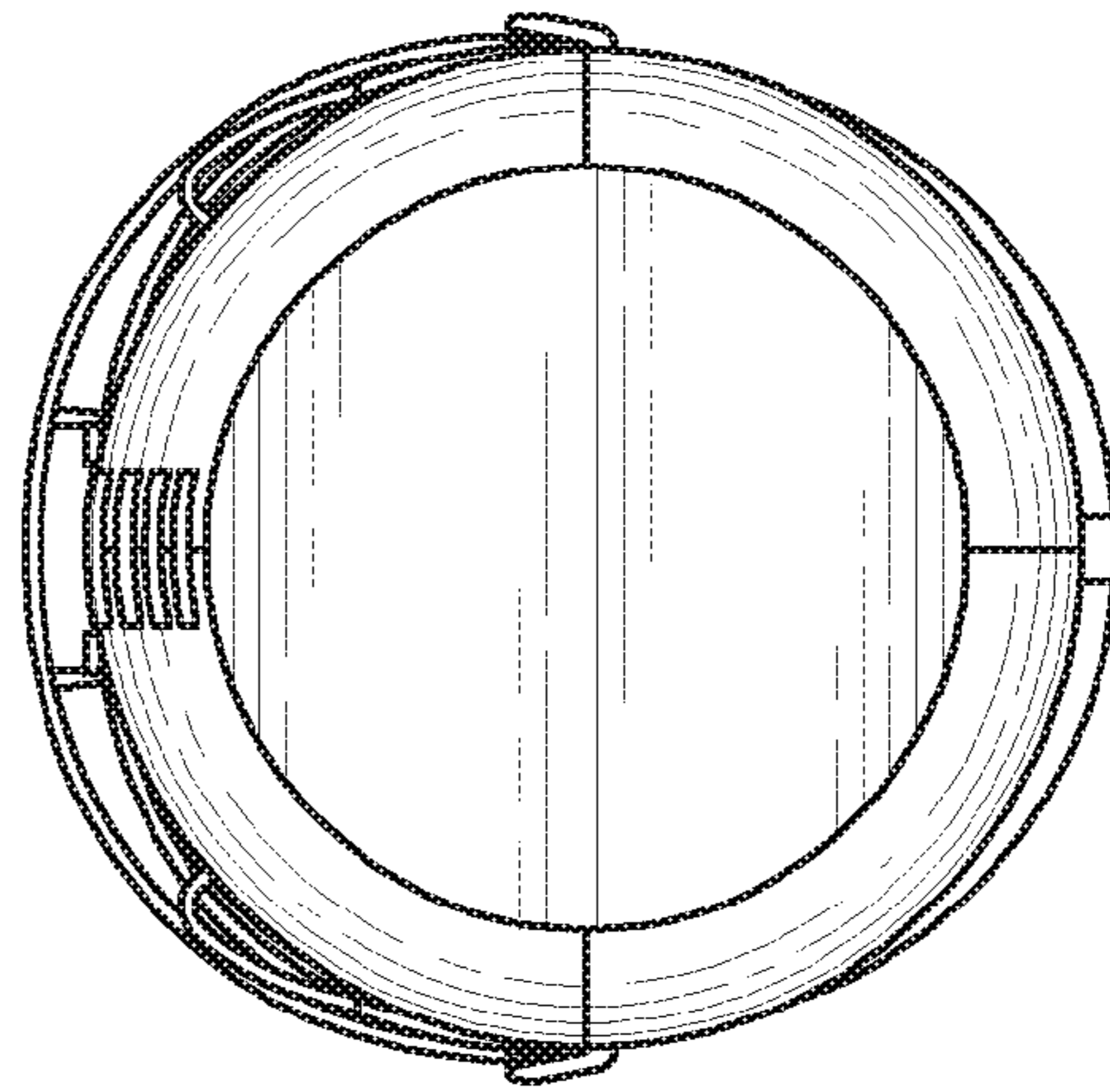

FIG. 5

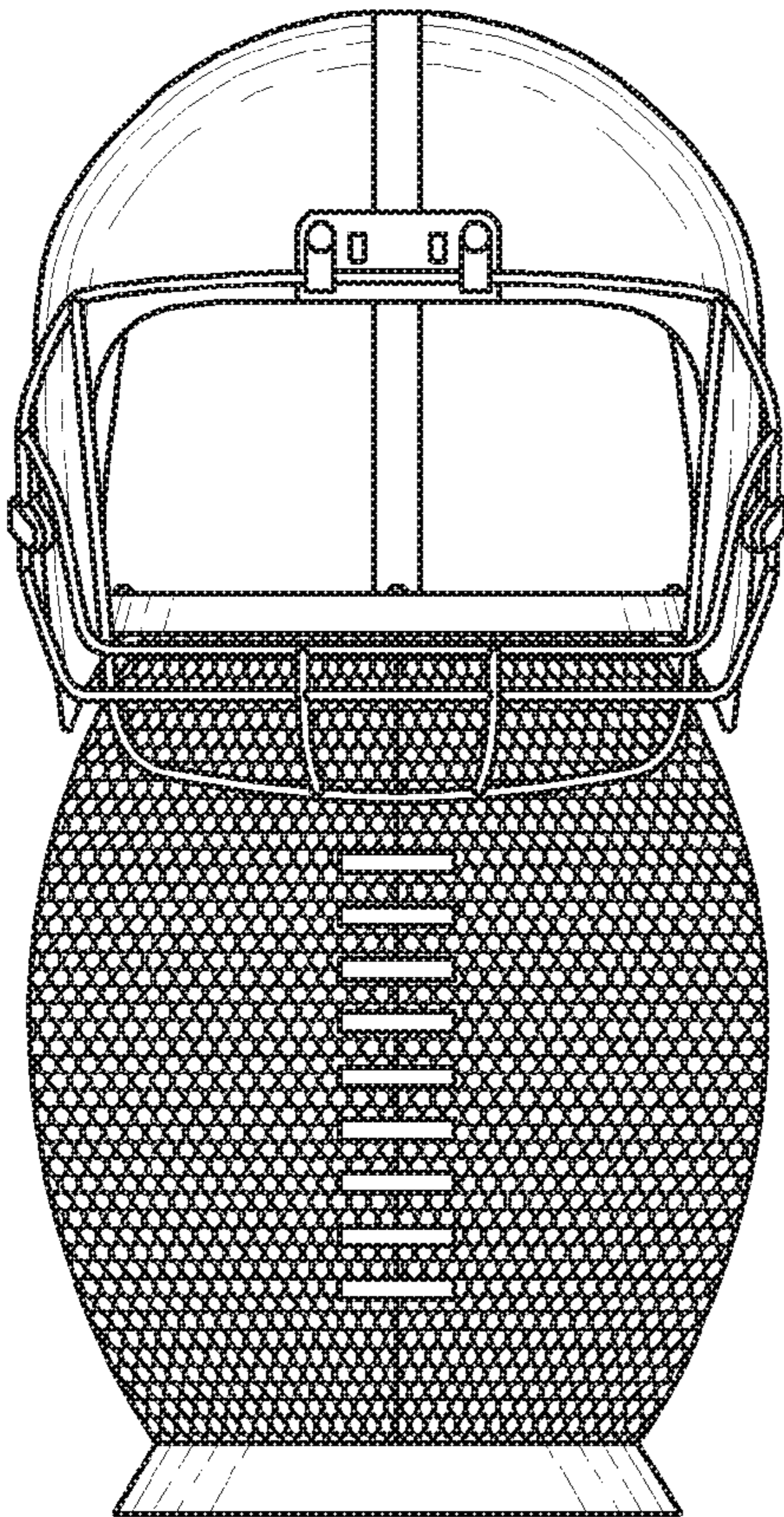

FIG. 6

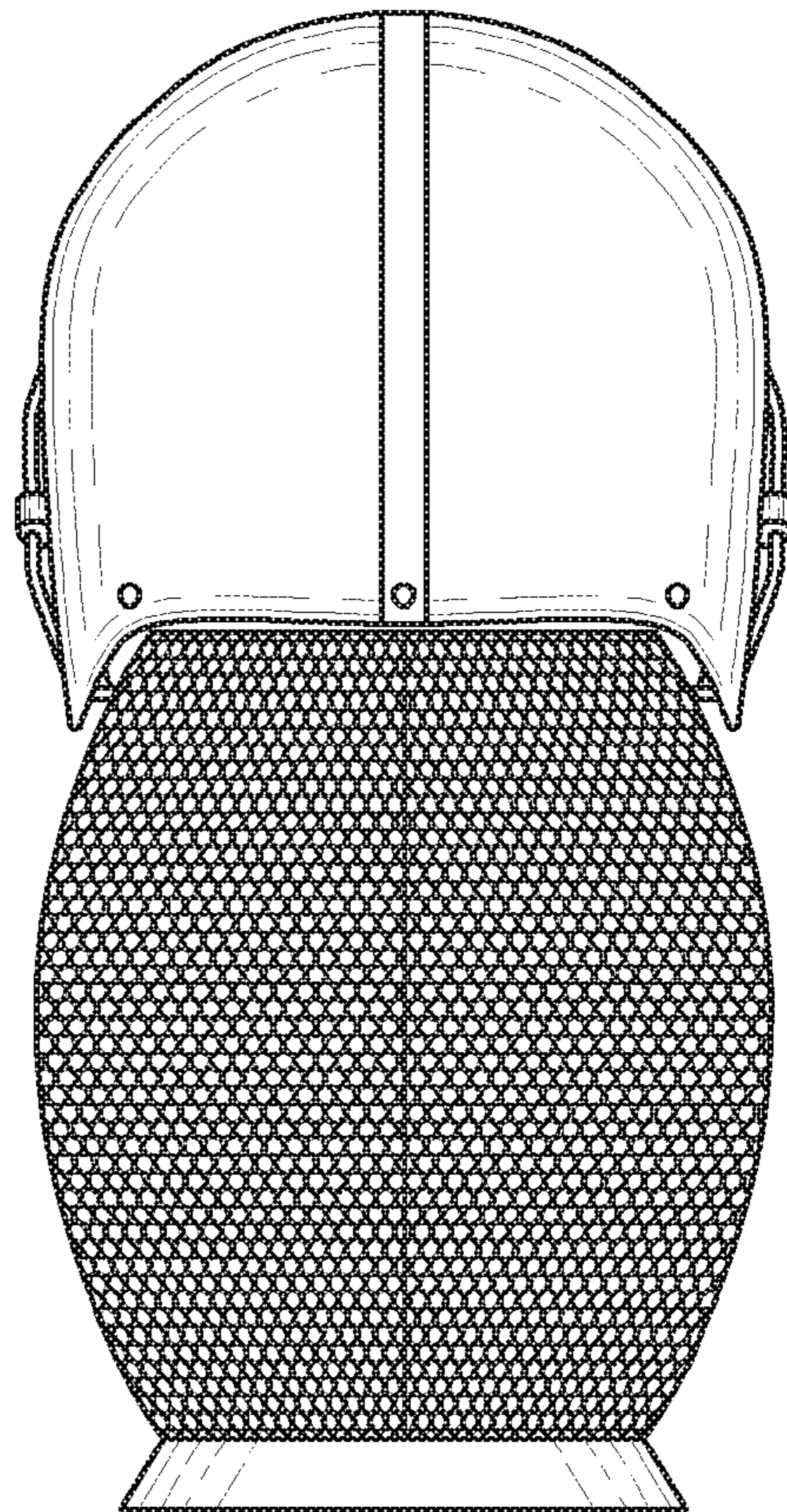

FIG. 7

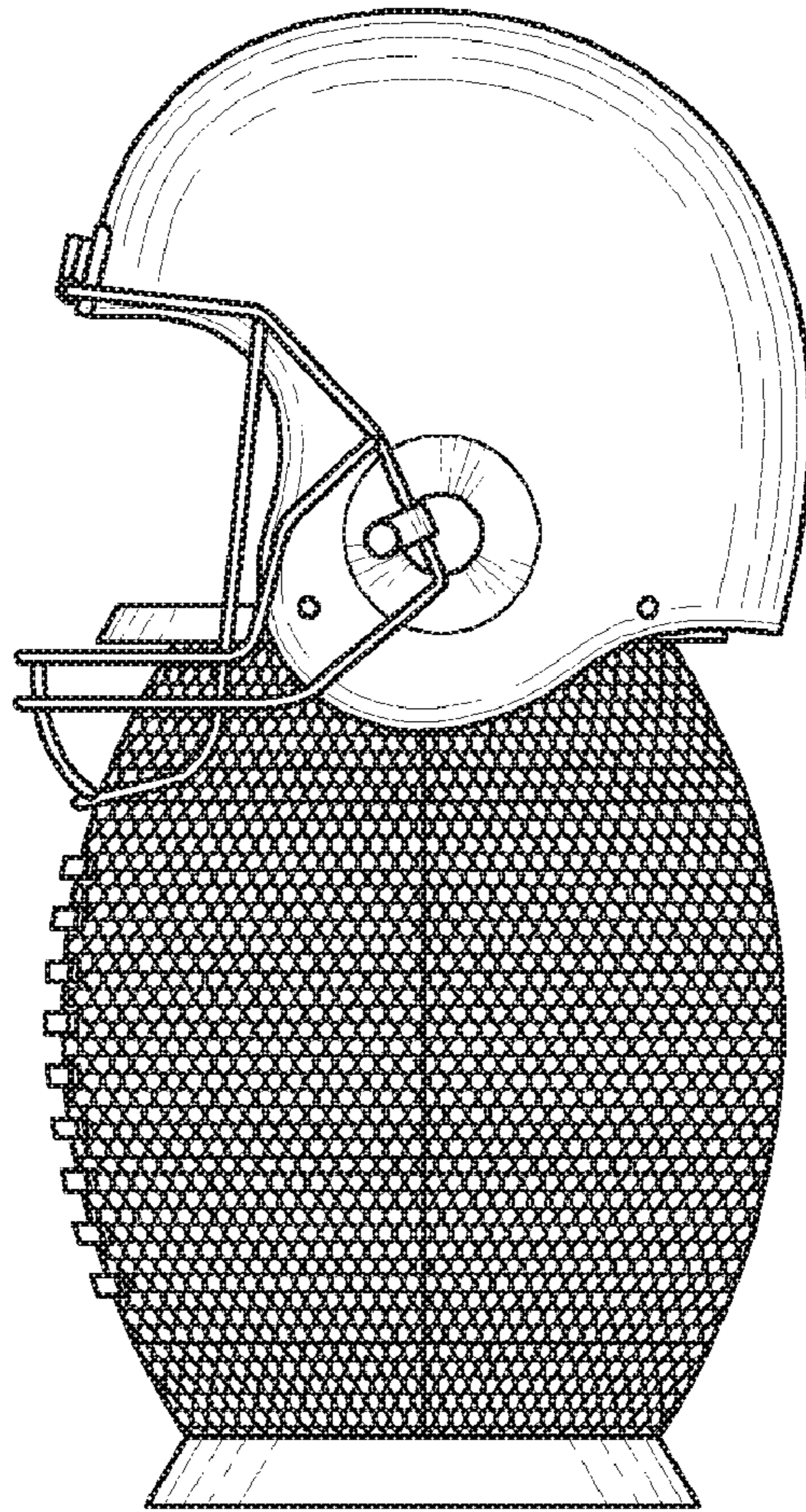

FIG. 8

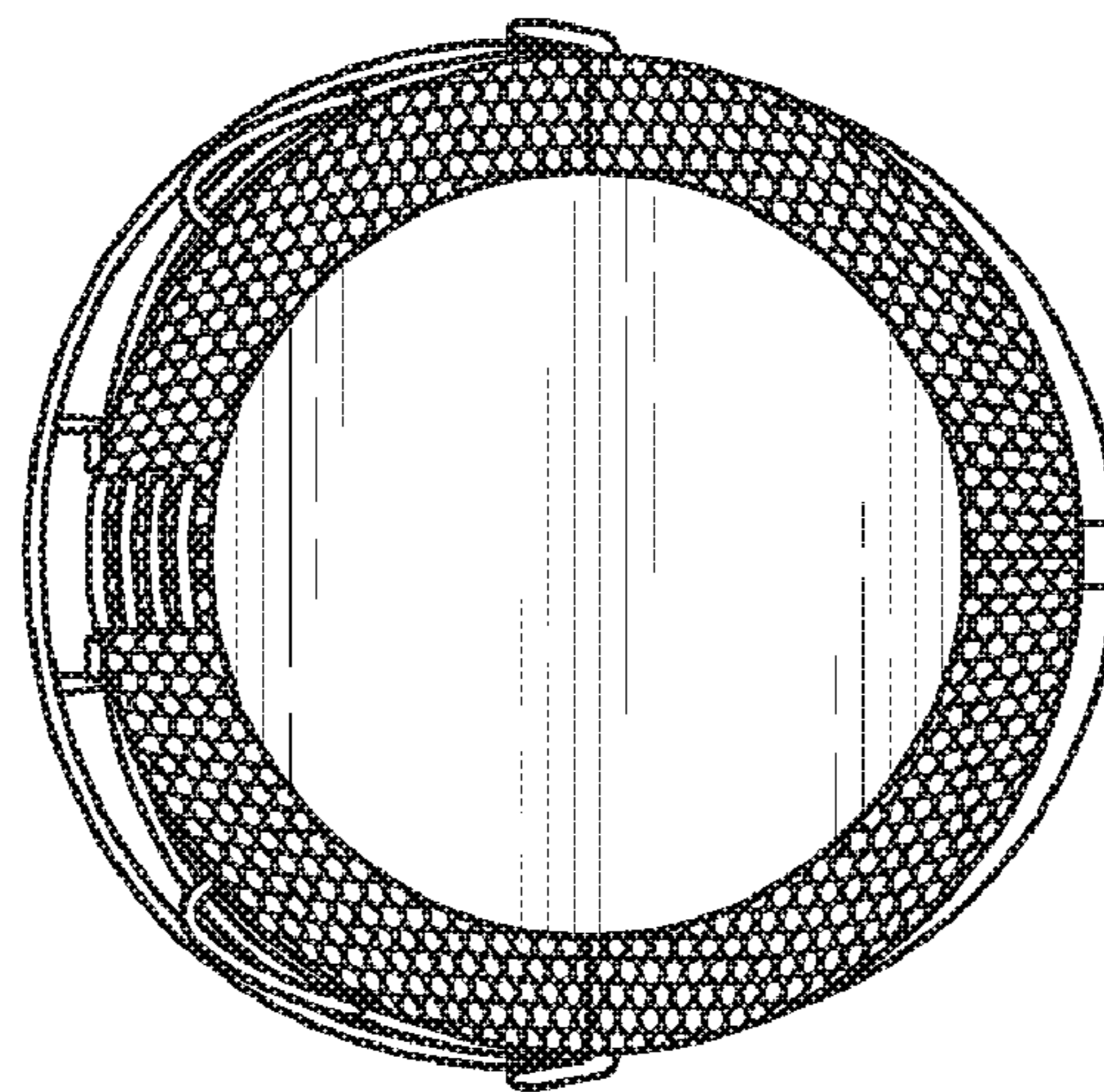

FIG. 9

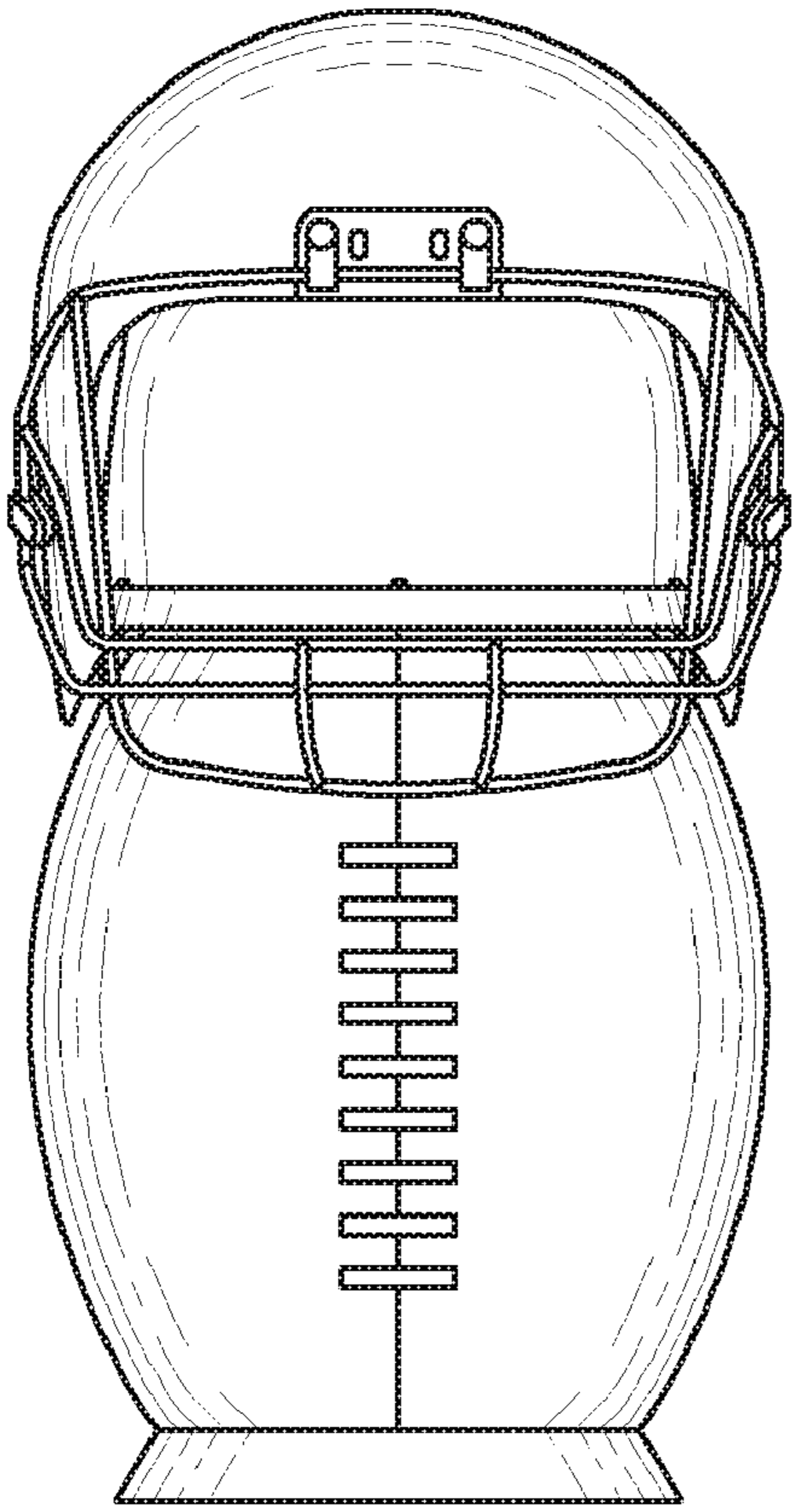

FIG. 10

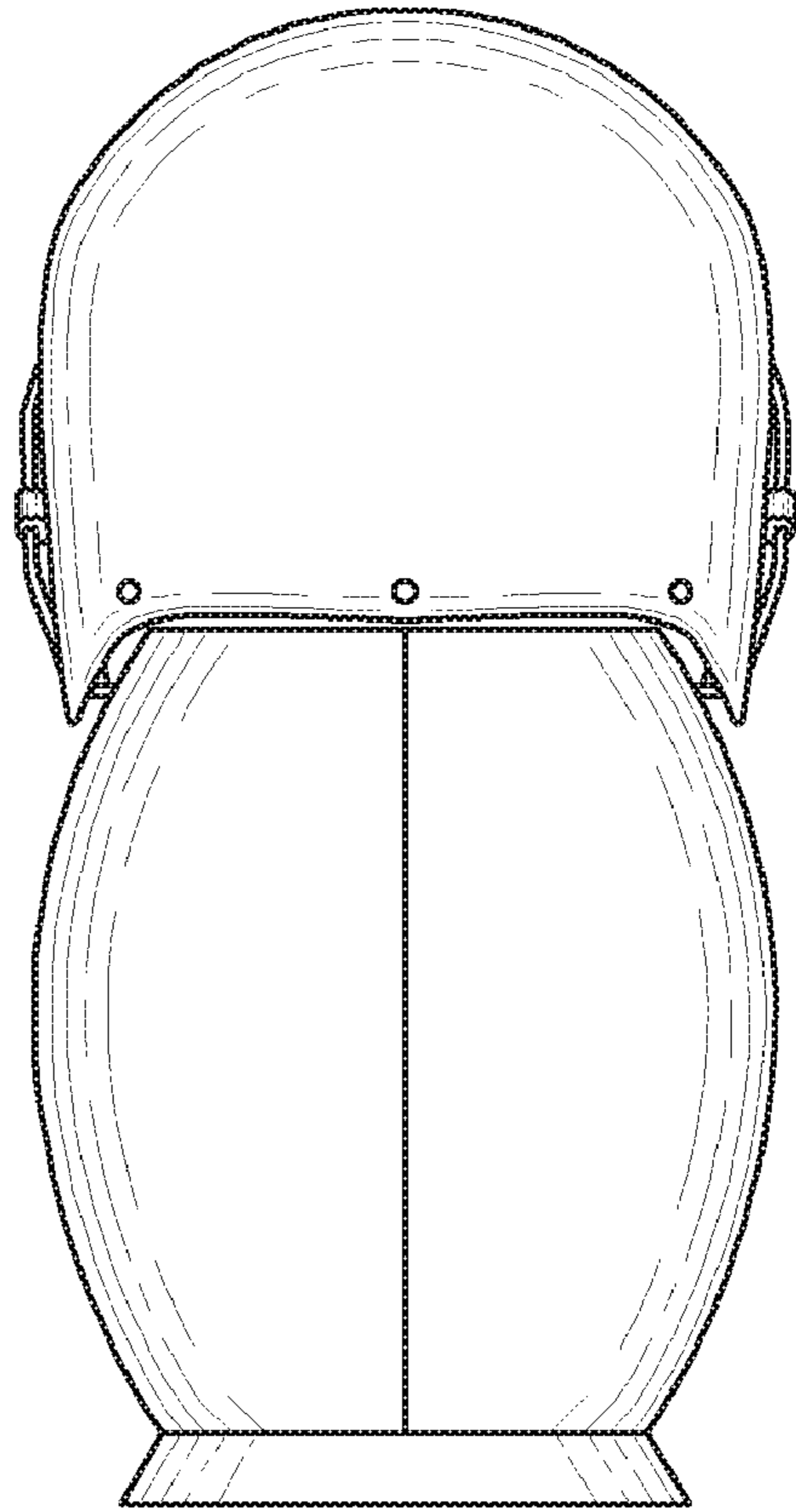

FIG. 11

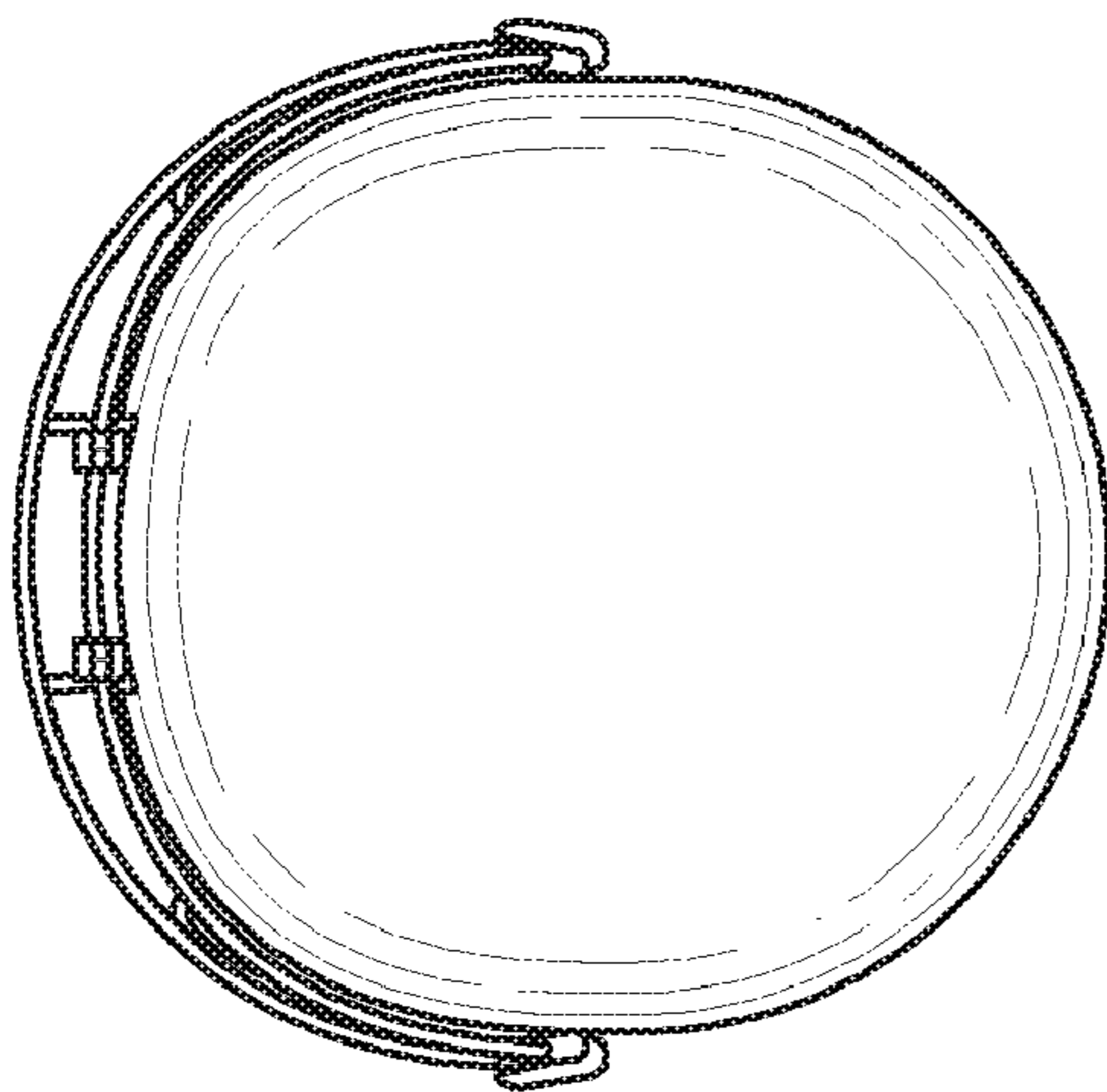

FIG. 12

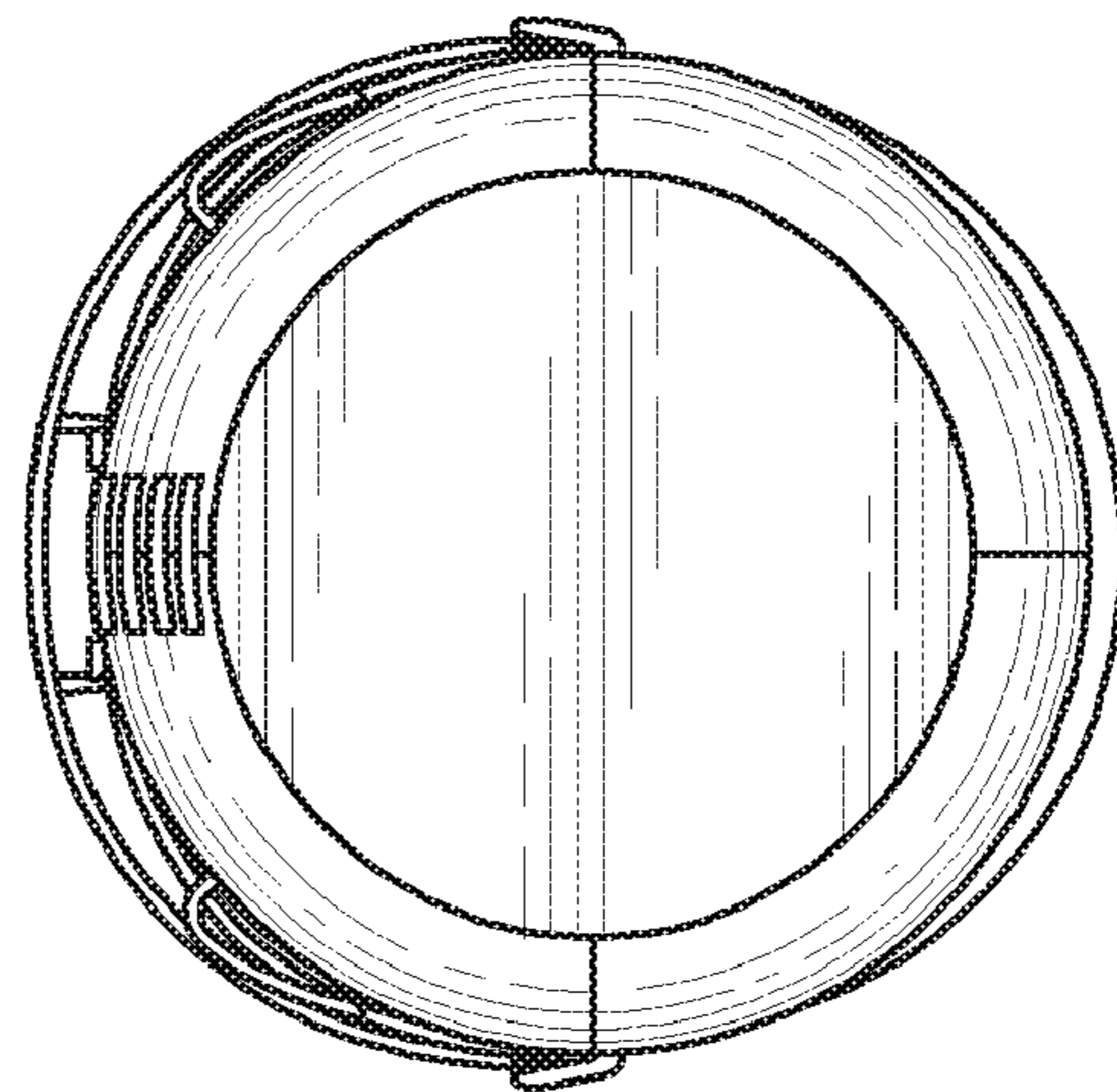

FIG. 13

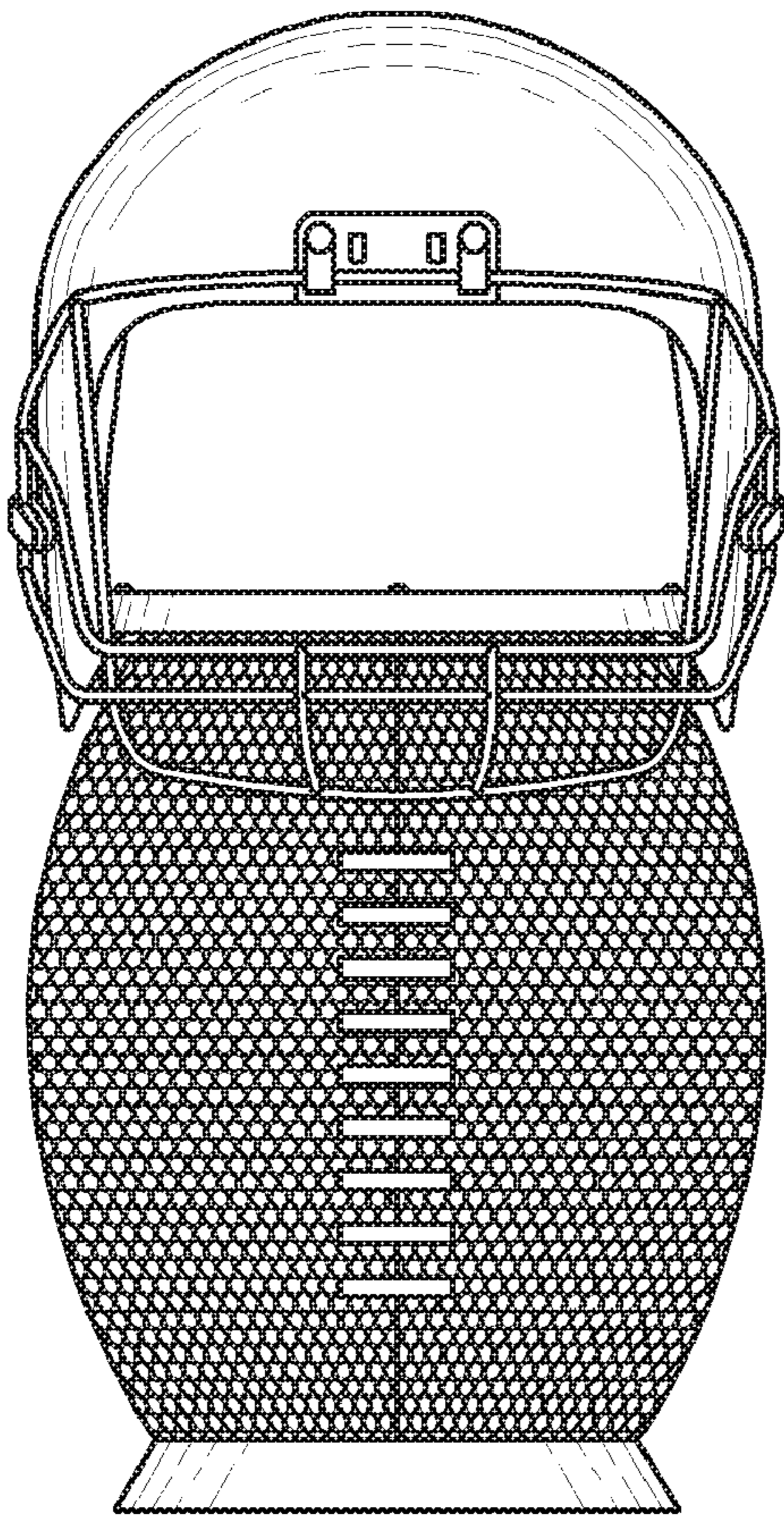

FIG. 14

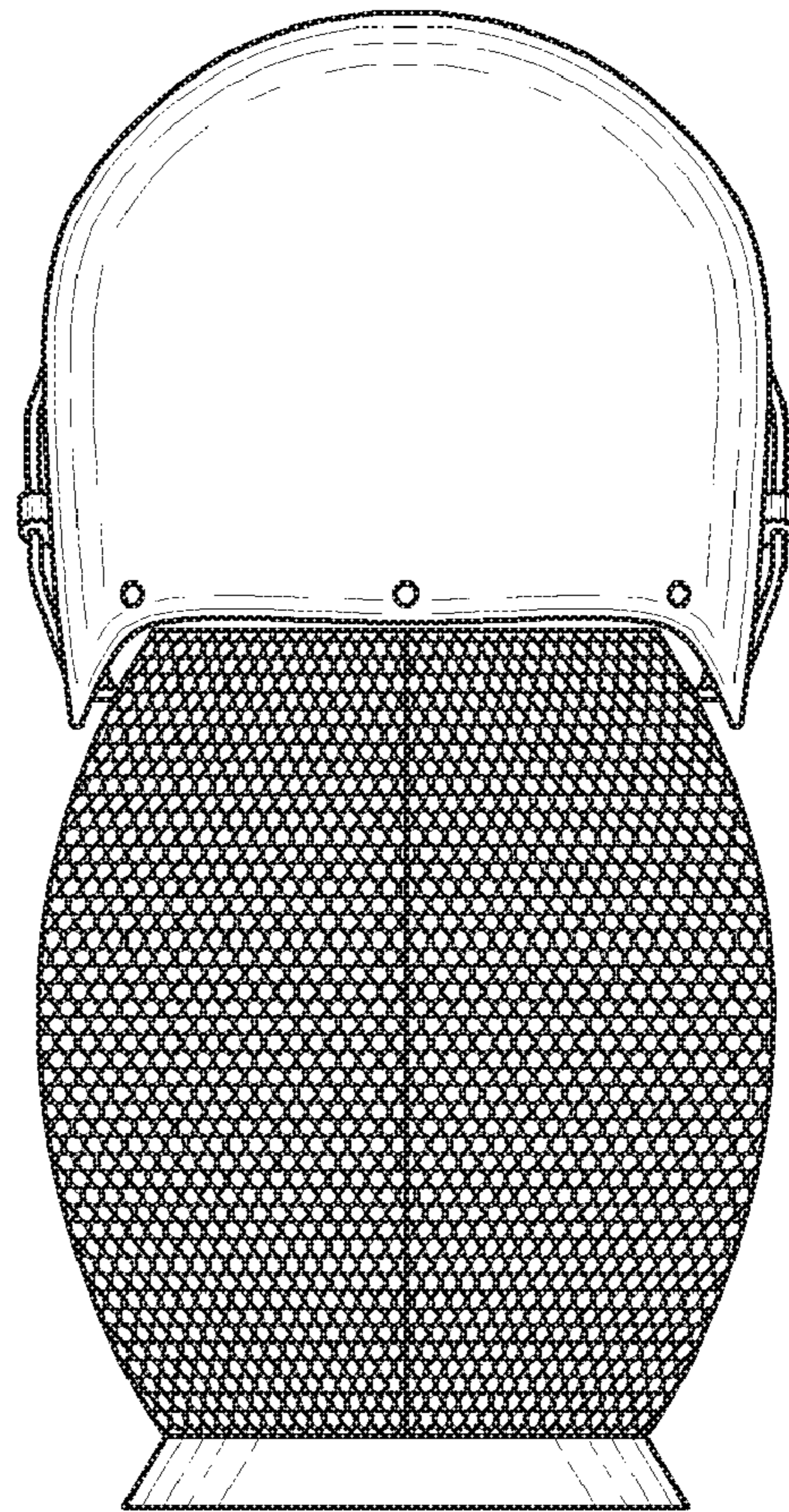

FIG. 15

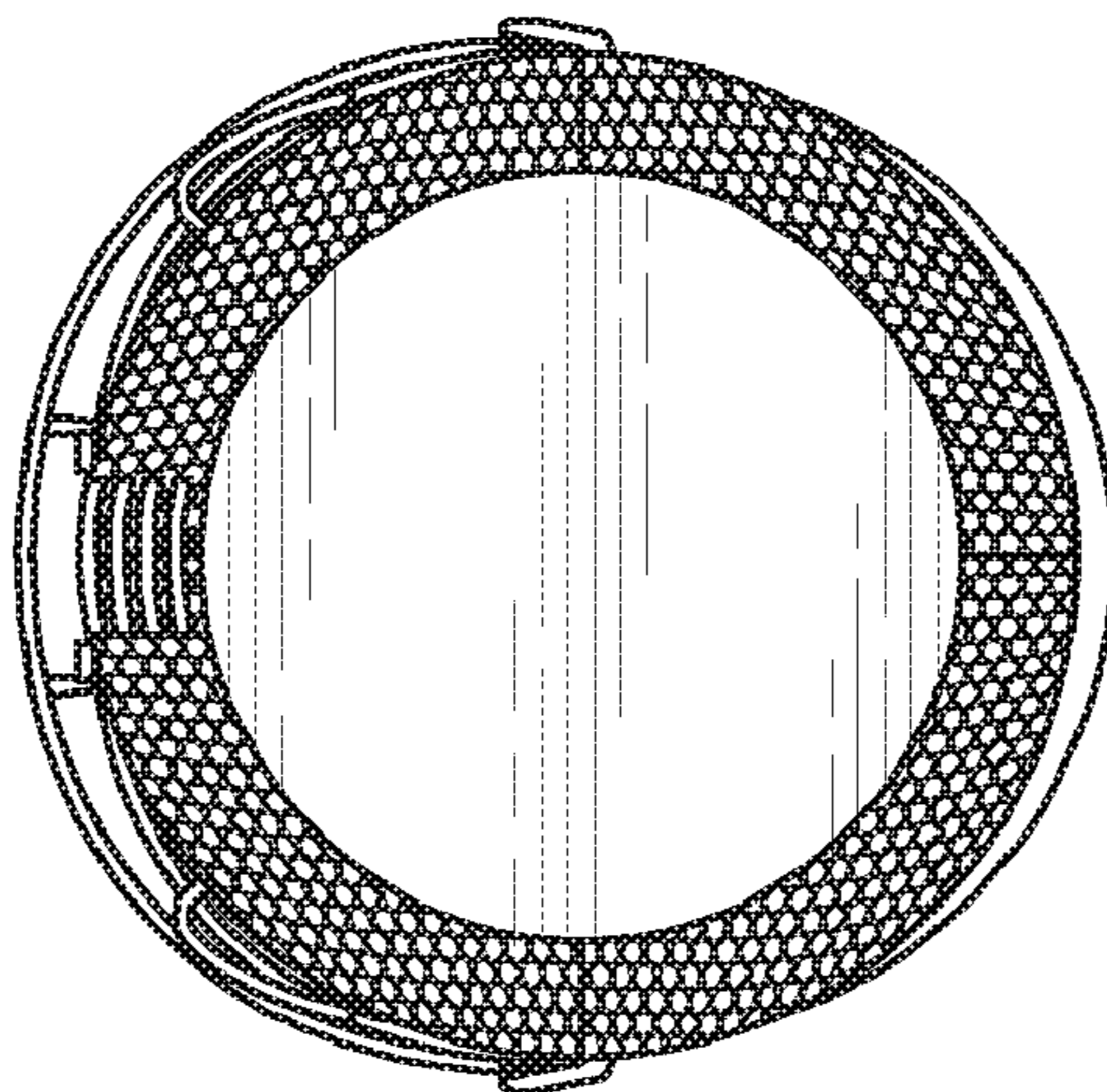

FIG. 16