



US00D624570S

(12) **United States Design Patent**
Fukano et al.

(10) **Patent No.:** **US D624,570 S**
(45) **Date of Patent:** **** Sep. 28, 2010**

(54) **ELECTRIC ACTUATOR**

(76) Inventors: **Yoshihiro Fukano**, c/o SMC Corporation Tsukuba Technical Center, 4-2-2, Kinunodai, Tsukubamirai-Shi (JP) 300-2493; **Shoichi Makado**, c/o SMC Corporation Tsukuba Technical Center, 4-2-2, Kinunodai, Tsukubamirai-Shi (JP) 300-2493; **Junichi Saitoh**, c/o SMC Corporation Tsukuba Technical Center, 4-2-2, Kinunodai, Tsukubamirai-Shi (JP) 300-2493

(**) Term: **14 Years**

(21) Appl. No.: **29/338,985**

(22) Filed: **Jun. 22, 2009**

(30) **Foreign Application Priority Data**

Jan. 7, 2009 (JP) 2009-000198

(51) **LOC (9) Cl.** **15-09**

(52) **U.S. Cl.** **D15/143**

(58) **Field of Classification Search** D13/158, D13/162, 184; D15/5, 7, 9, 143, 148, 199; 74/89.15, 411.5, 490.09; 297/14, 325, 327; 310/10, 12, 15, 20, 80, 300

See application file for complete search history.

(56) **References Cited**

U.S. PATENT DOCUMENTS

D412,918 S * 8/1999 Nagai et al. D15/149

D413,129 S * 8/1999 Nagai et al. D15/199
D523,880 S * 6/2006 Christensen et al. D15/143
D611,514 S * 3/2010 Fukano et al. D15/143
2006/0081078 A1 * 4/2006 Nagai et al. 74/89.23
2008/0048514 A1 * 2/2008 Hoffmann et al. 310/78

* cited by examiner

Primary Examiner—Sandra Snapp
Assistant Examiner—Patricia Palasik

(57) **CLAIM**

The ornamental design for an electric actuator, as shown and described.

DESCRIPTION

FIG. 1 shows a front view of an electric actuator showing my new design;

FIG. 2 shows a rear view thereof;

FIG. 3 shows a right side view thereof;

FIG. 4 shows a left side view thereof;

FIG. 5 shows a top view thereof;

FIG. 6 shows a bottom view thereof; and,

FIG. 7 shows a top, front and left side perspective view thereof.

1 Claim, 4 Drawing Sheets

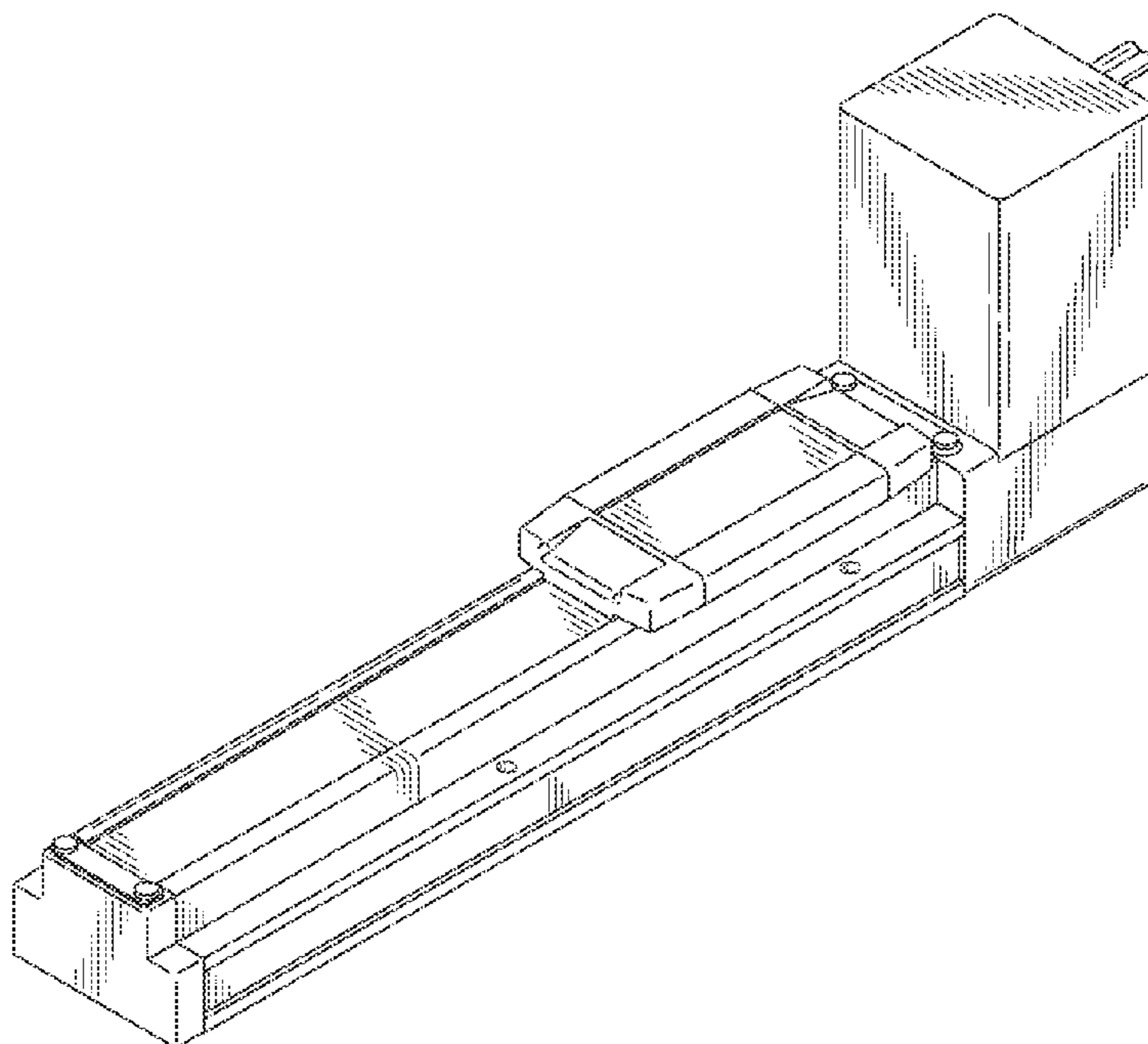

FIG. 1

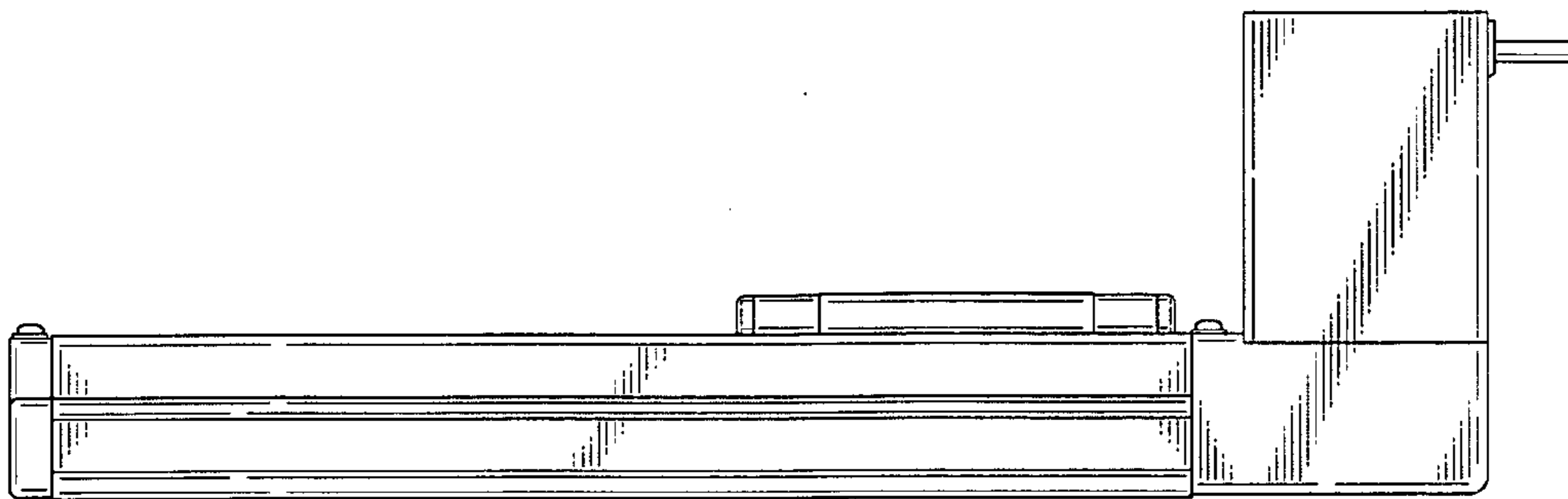

FIG. 2

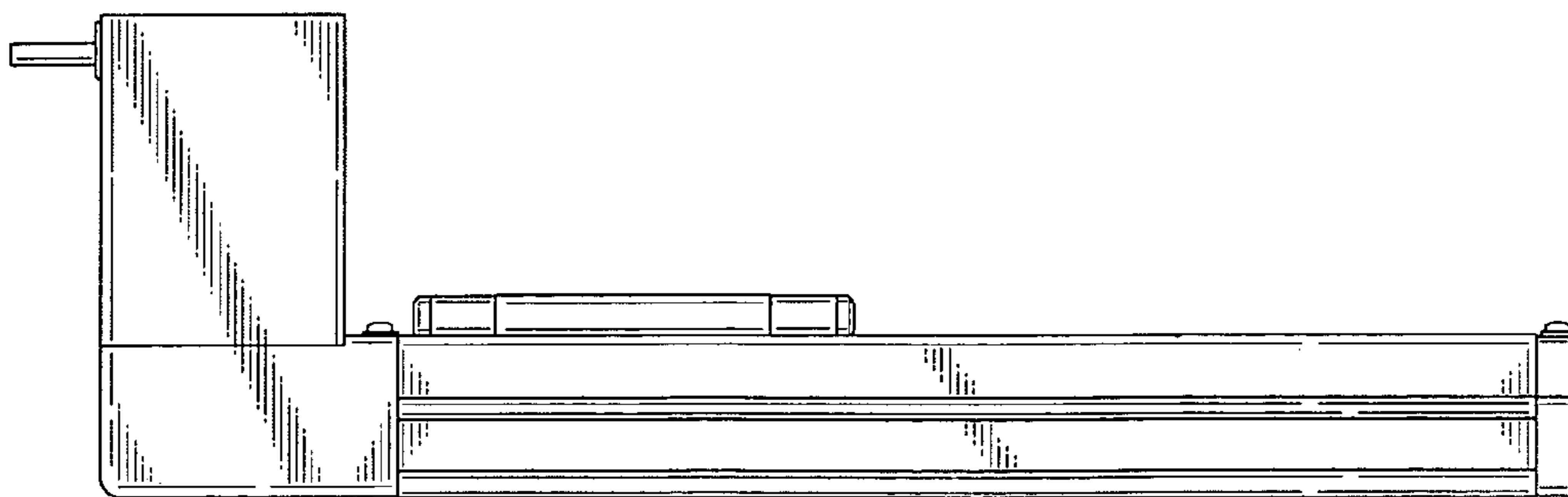

FIG. 3

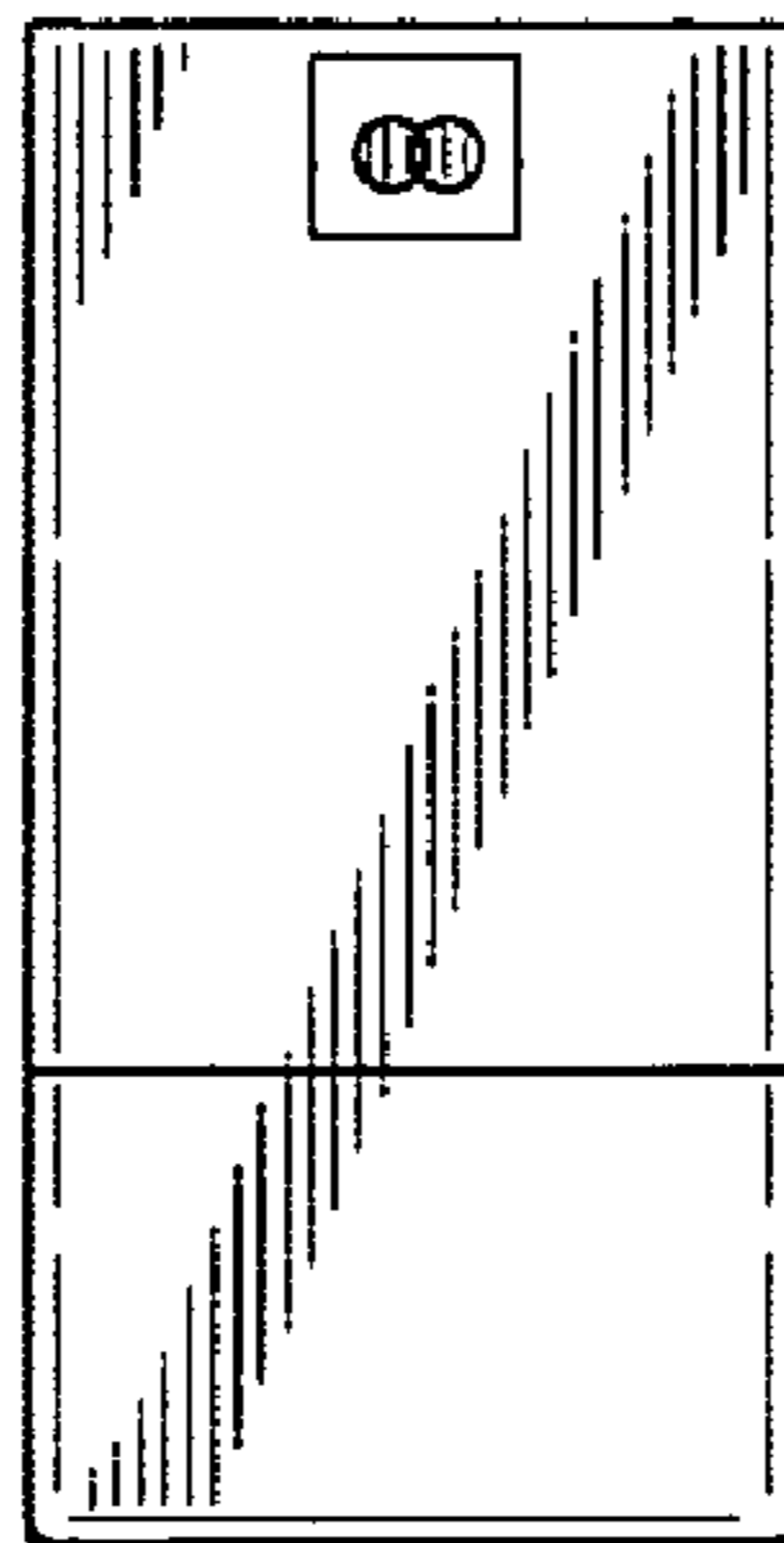

FIG. 4

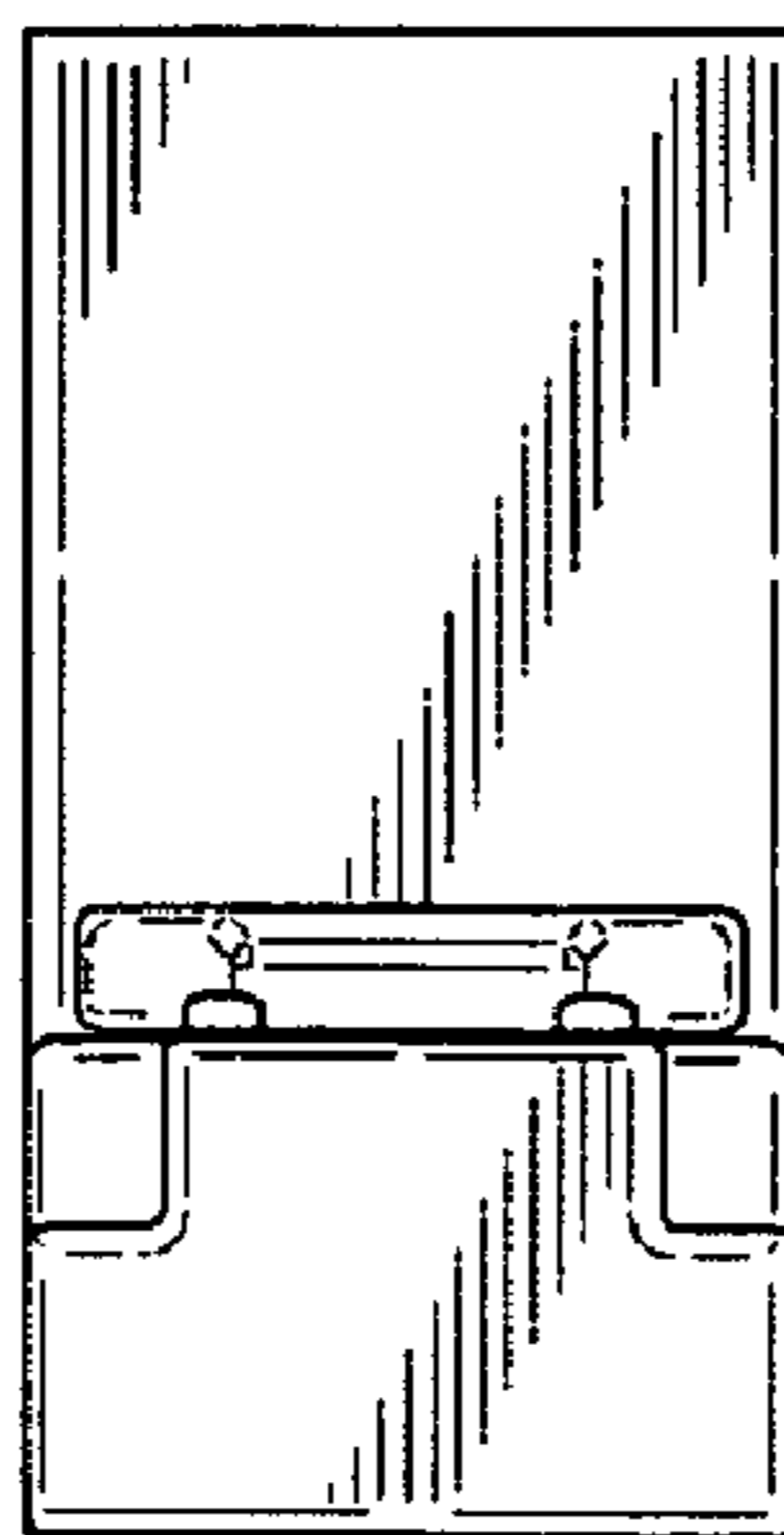

FIG. 5

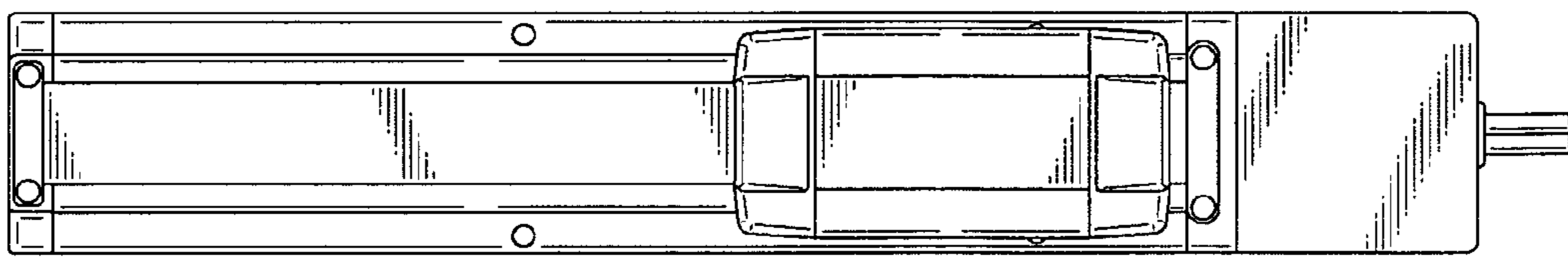

FIG. 6

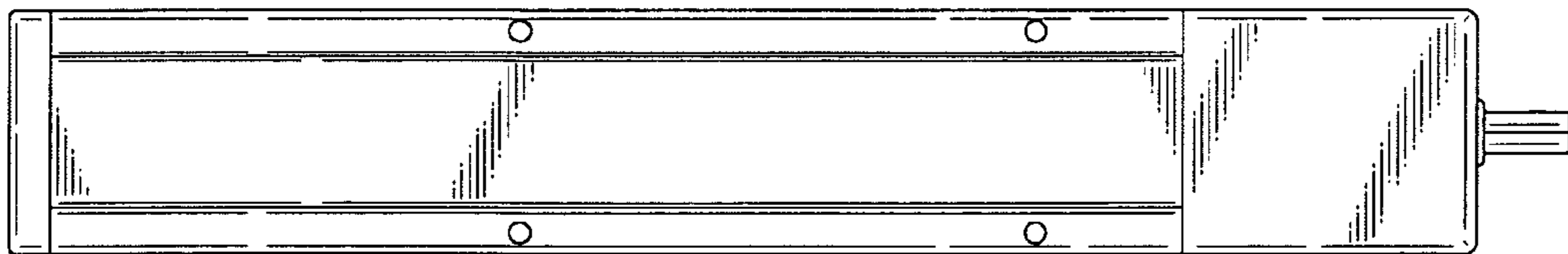

FIG. 7

