



US00D624550S

(12) **United States Design Patent**
McLean

(10) **Patent No.:** **US D624,550 S**

(45) **Date of Patent:** **** *Sep. 28, 2010**

(54) **USB FLASH DRIVE**

6,786,743 B2 9/2004 Huang
6,902,432 B2 6/2005 Morikawa et al.

(76) Inventor: **James McLean**, 398 Longcommon Rd.,
Riverside, IL (US) 60546

(Continued)

(*) Notice: This patent is subject to a terminal disclaimer.

OTHER PUBLICATIONS

(**) Term: **14 Years**

A-Data Technology, [online], [retrieved on Jul. 3, 2007]. Retrieved from the Internet <URL: http://www.adata.com.tw/adata_en/products_search.php>.*

(21) Appl. No.: **29/343,844**

(Continued)

(22) Filed: **Sep. 21, 2009**

Primary Examiner—Cathron C Brooks

Assistant Examiner—Karen E Kearney

(74) *Attorney, Agent, or Firm*—Lempia Braidwood LLC

Related U.S. Application Data

(63) Continuation of application No. 29/322,926, filed on Aug. 14, 2008, now Pat. No. Des. 602,940.

(51) **LOC (9) Cl.** **14-02**

(52) **U.S. Cl.** **D14/480.3; D17/12**

(58) **Field of Classification Search** D14/356,
D14/411, 433, 435.1, 436, 137, 155, 167,
D14/168, 203.1–203.8, 240, 242, 299, 480.1–480.7,
D14/484.1; D3/201, 273; D13/107, 108,
D13/149, 184; 710/300, 301; 439/131, 135–147;
361/679.31, 679.33, 679.4, 752; 711/100,
711/115

See application file for complete search history.

(57) **CLAIM**

The ornamental design for a “USB flash drive,” as shown and described.

DESCRIPTION

FIG. 1 is a top, front, and right side perspective view of my new design for a USB flash drive;

FIG. 2 is a front view of the USB flash drive shown in FIG. 1;

FIG. 3 is a rear view of the USB flash drive shown in FIG. 1;

FIG. 4 is a right side view of the USB flash drive shown in FIG. 1;

FIG. 5 is a left side view of the USB flash drive shown in FIG. 1;

FIG. 6 is a top view of the USB flash drive shown in FIG. 1; and,

FIG. 7 is a bottom view of the USB flash drive shown in FIG. 1.

The dashed lines are for illustrative purposes only and form no part of my claimed design.

(56) **References Cited**

U.S. PATENT DOCUMENTS

463,034 A	11/1891	Foote et al.
505,493 A	9/1893	Strauss
546,157 A	9/1895	Jesselson
588,920 A	8/1897	Hohner
D68,751 S	11/1925	Katz
D74,704 S	3/1928	Strauss
1,671,309 A	5/1928	Newman
1,752,988 A	4/1930	Haussler
D173,426 S	11/1954	Gurtov
4,984,499 A	1/1991	Schille
6,224,455 B1	5/2001	Laurienzo

1 Claim, 3 Drawing Sheets

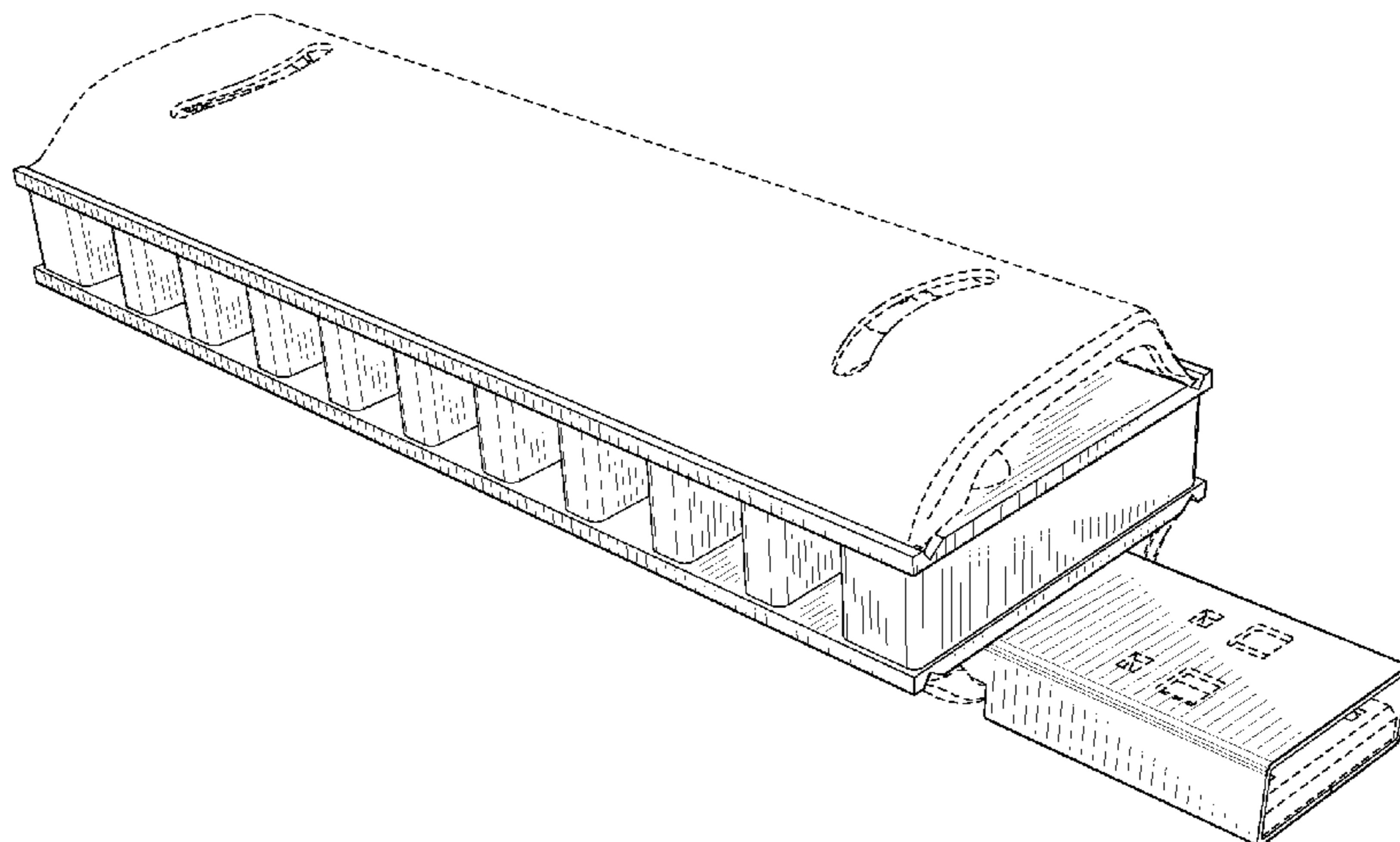

US D624,550 S

Page 2

U.S. PATENT DOCUMENTS

D531,190 S * 10/2006 Lee et al. D14/203.3
7,146,667 B2 12/2006 Elsener
D538,223 S 3/2007 Yang
D543,203 S 5/2007 Park et al.
7,214,075 B2* 5/2007 He et al. 439/135
D567,238 S 4/2008 Patton et al.
D572,248 S 7/2008 Jen
D582,417 S * 12/2008 Sheba et al. D14/434
D583,374 S 12/2008 Otsuka
D602,940 S * 10/2009 McLean D14/480.3
D611,470 S * 3/2010 Andre et al. D14/496

2004/0080989 A1 4/2004 Yu
2009/0147460 A1* 6/2009 Kung 361/679.31

OTHER PUBLICATIONS

Product Specifications for Toshiba TransMemory Product Nos. THNU301G/2GEOP5BA, THNU304G/8GE1P5BA, Sep. 1, 2007 (1 page).

Product Information for Hohner Puck Inc. Harmonica from HohnerUSA.com (1 page).

Product Data Sheet for Crucial Flash Gizmol Jr. USB Flash Drive, 2007 (2 pages).

* cited by examiner

FIG. 1

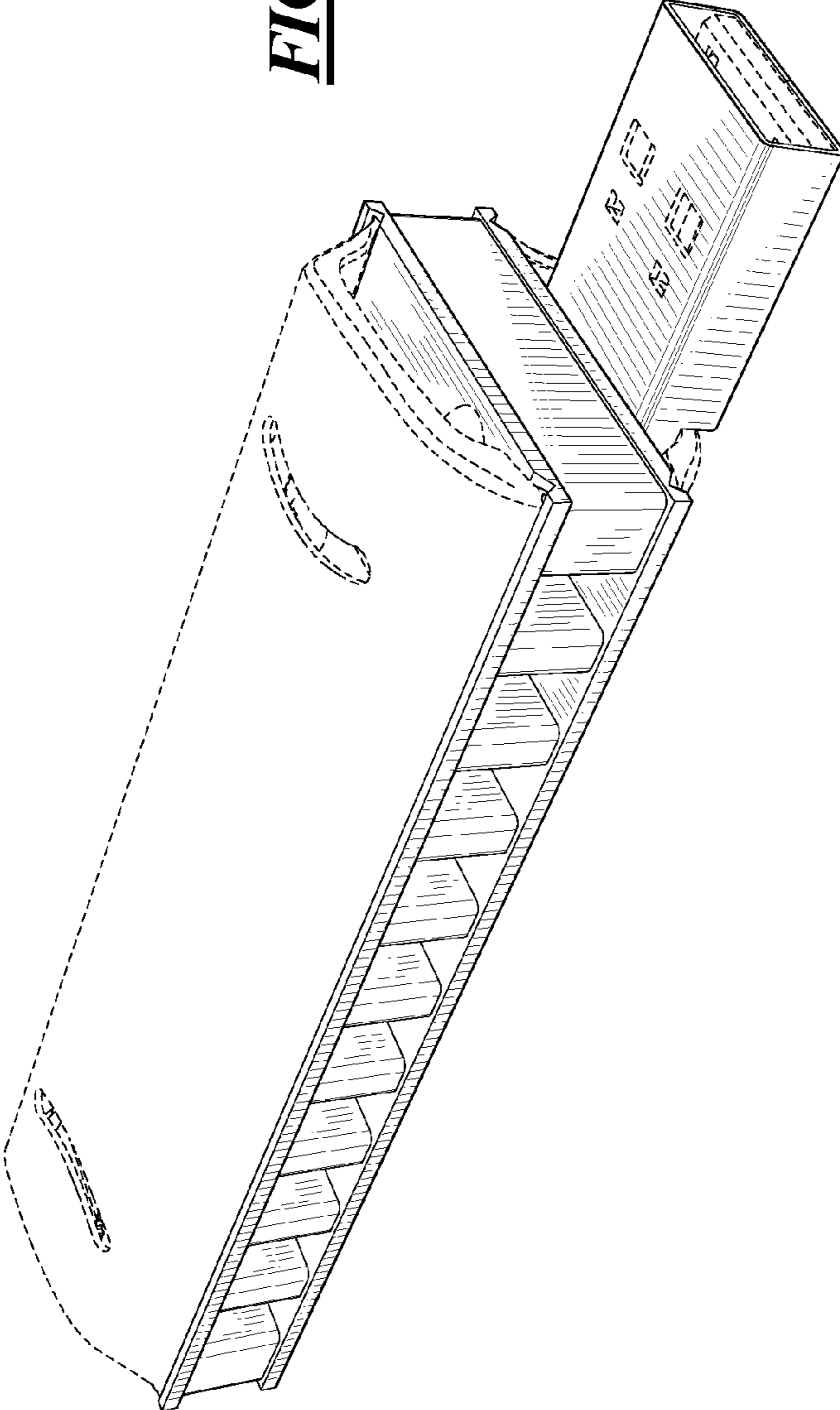

FIG. 3

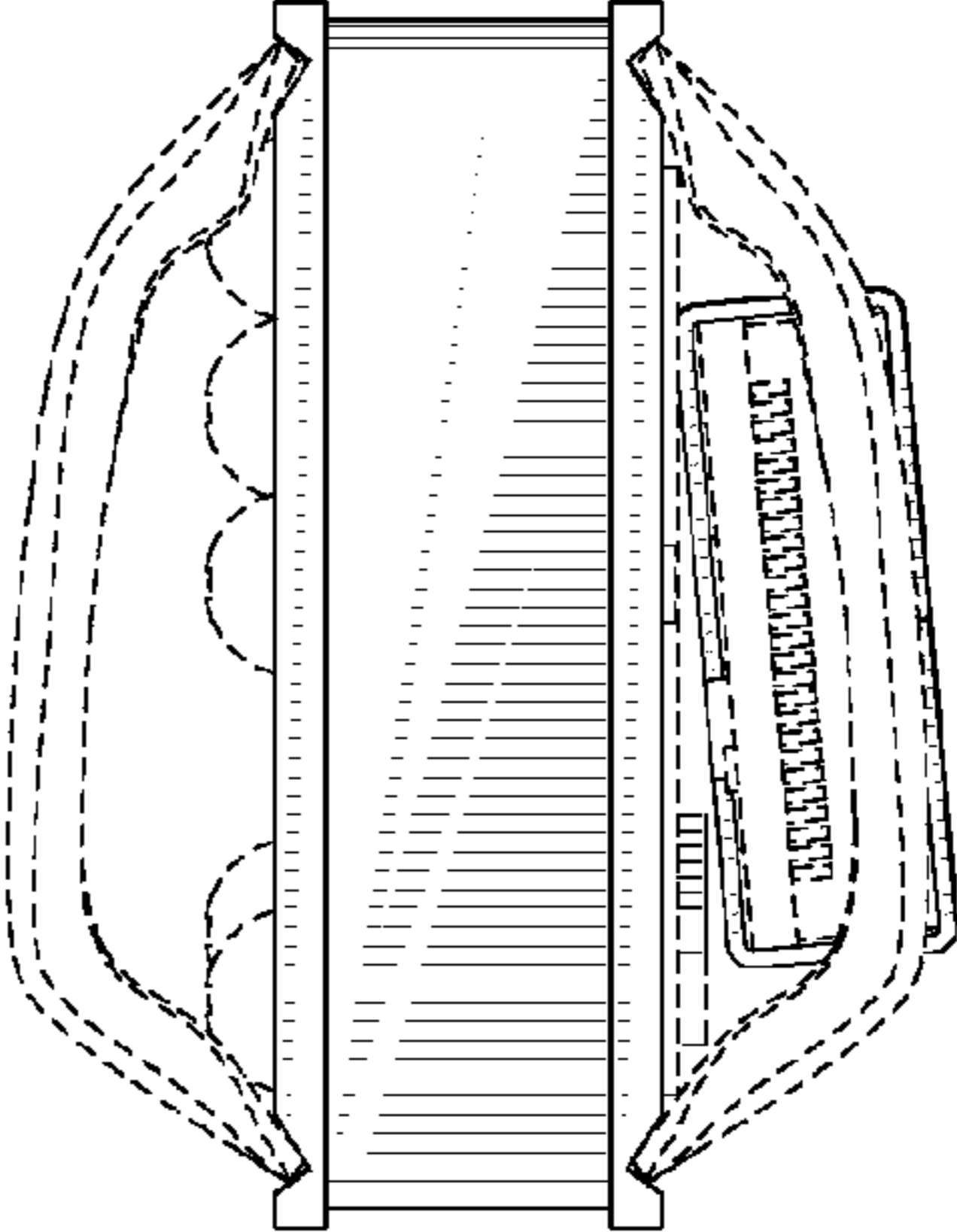
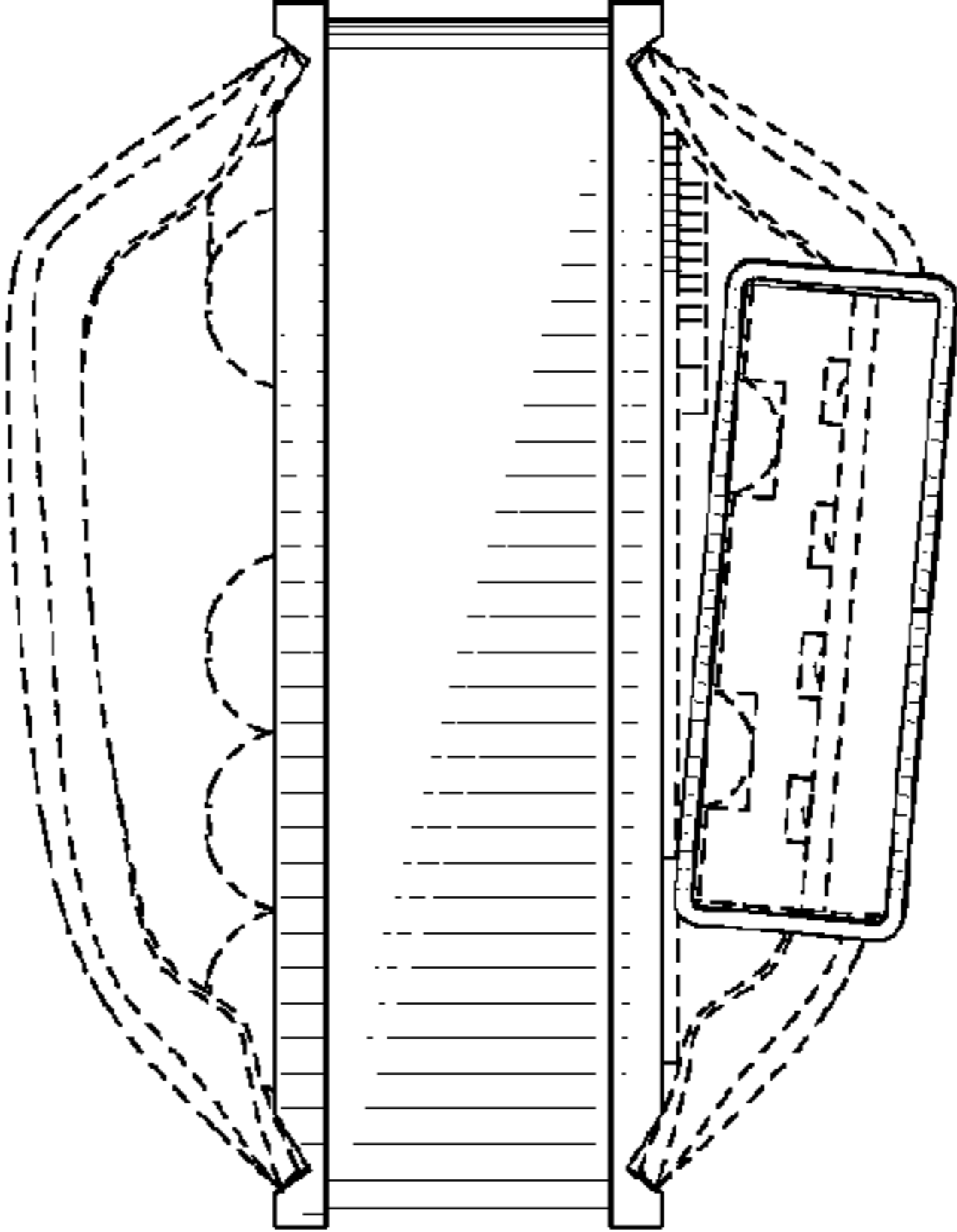

FIG. 2



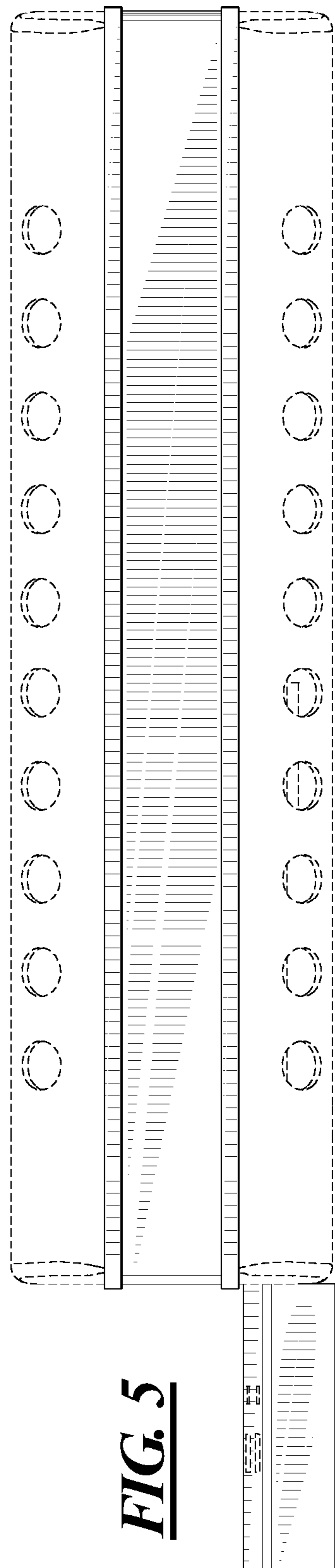
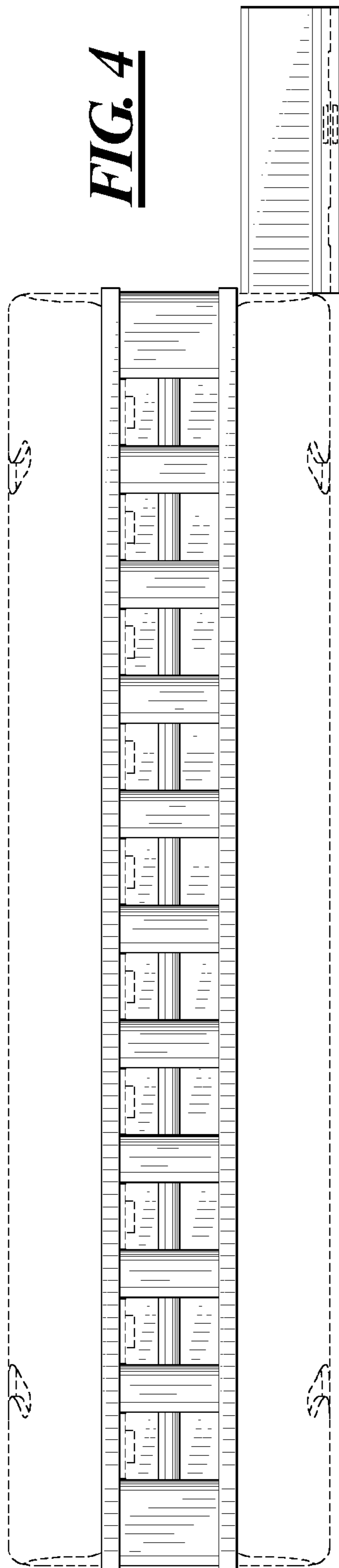

FIG. 6

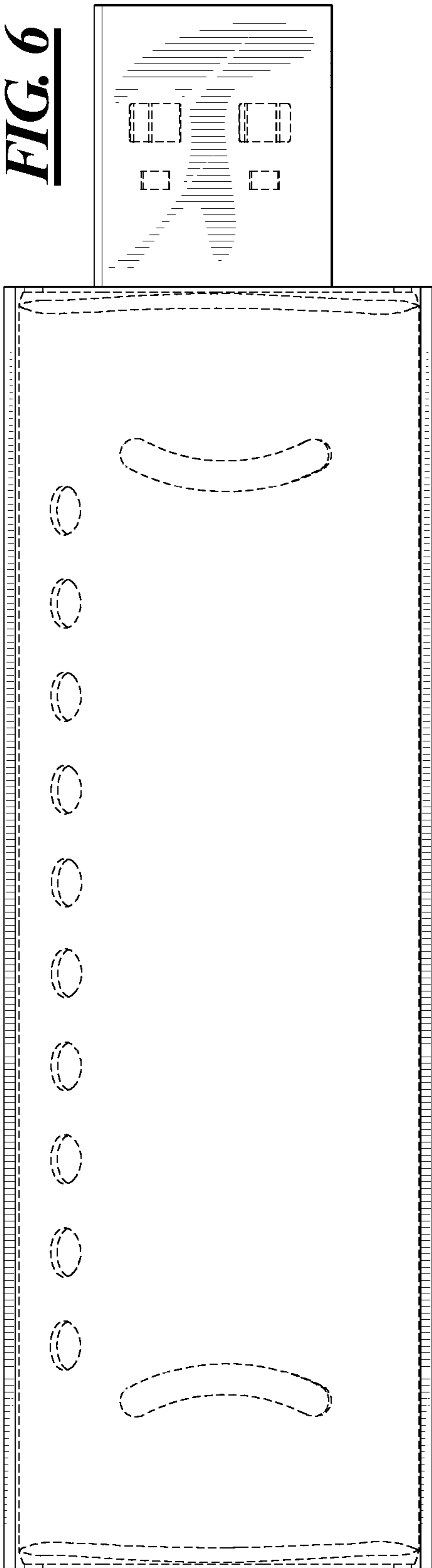

FIG. 7

