



US00D624432S

(12) **United States Design Patent**
Fox et al.

(10) **Patent No.:** **US D624,432 S**

(45) **Date of Patent:** **** Sep. 28, 2010**

(54) **COMBINED BEVERAGE BOTTLE AND CAP**

D558,057 S * 12/2007 De Baschmakoff D9/561
D584,960 S * 1/2009 Sherwood D9/686

(75) Inventors: **David Fox**, San Francisco, CA (US);
Jaime King, San Francisco, CA (US)

* cited by examiner

(73) Assignee: **Arta Holdings, LLC**, San Francisco, CA (US)

Primary Examiner—Stella M Reid

Assistant Examiner—Keli L Hill

(74) *Attorney, Agent, or Firm*—Townsend and Townsend and Crew LLP

(**) Term: **14 Years**

(21) Appl. No.: **29/331,289**

(57) **CLAIM**

(22) Filed: **Jan. 22, 2009**

The ornamental design for a combined beverage bottle and cap, as shown and described.

(51) **LOC (9) Cl.** **09-01**

(52) **U.S. Cl.** **D9/561**

(58) **Field of Classification Search** D9/434,
D9/435, 444, 516, 522, 529, 530, 537, 538,
D9/541, 543, 559, 561, 566, 567, 572, 575,
D9/682, 686, 687, 693, 694; 215/381–385;
220/662, 669

See application file for complete search history.

DESCRIPTION

FIG. 1 is a perspective view of a combined beverage bottle and cap showing our new design;

FIG. 2 is a front elevational view thereof;

FIG. 3 is a rear elevational view thereof;

FIG. 4 is a left side elevational view thereof;

FIG. 5 is a right side elevational view thereof;

FIG. 6 is a top plan view thereof; and,

FIG. 7 is a bottom plan view thereof.

The stipple shading shown in the drawings represents a contrasting surface.

(56) **References Cited**

U.S. PATENT DOCUMENTS

D199,203 S * 9/1964 Dailey D9/561
D489,271 S * 5/2004 Soomar D9/561
D496,286 S * 9/2004 Krunas D9/572
D500,448 S * 1/2005 Krunas D9/572
D541,671 S * 5/2007 Stick et al. D9/744

1 Claim, 6 Drawing Sheets

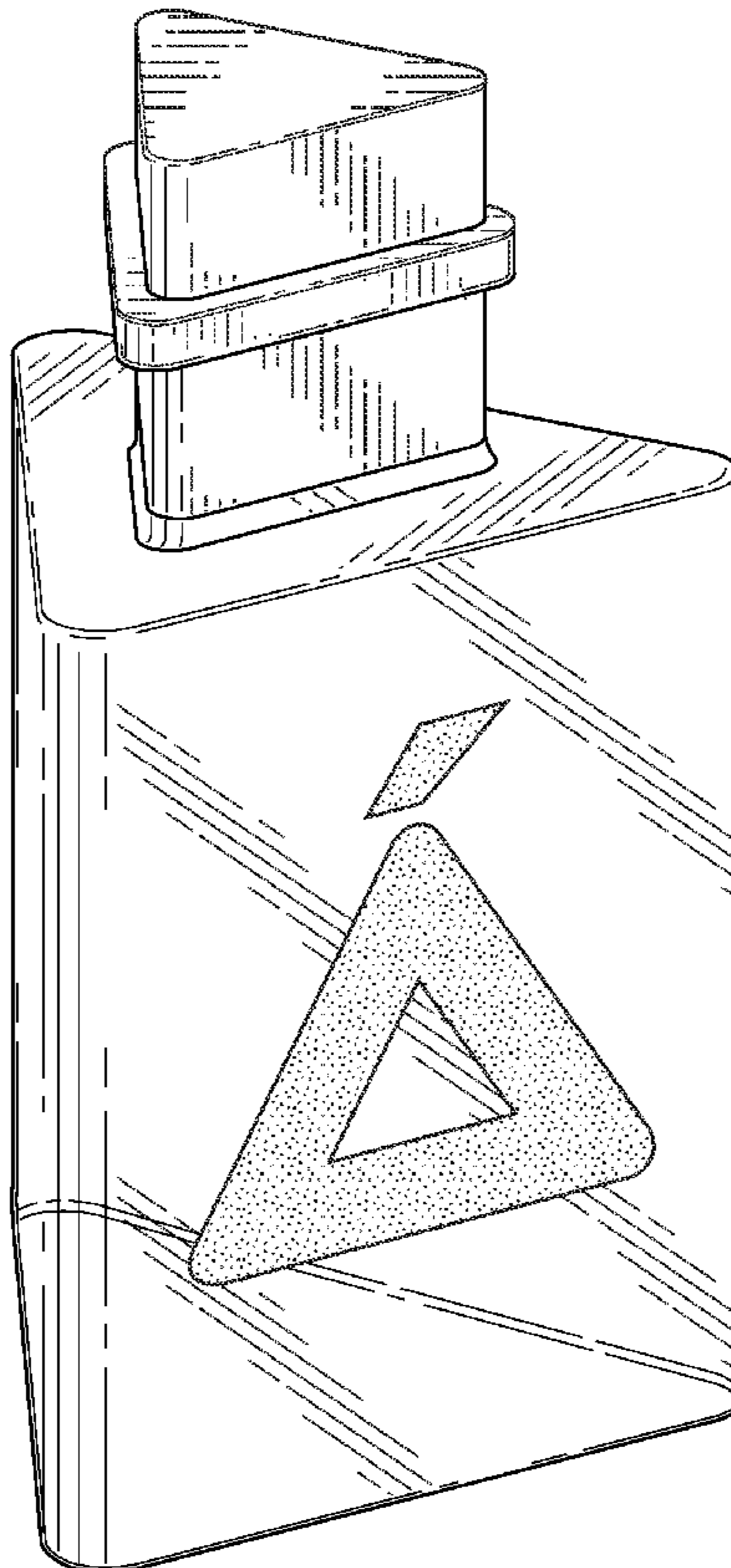

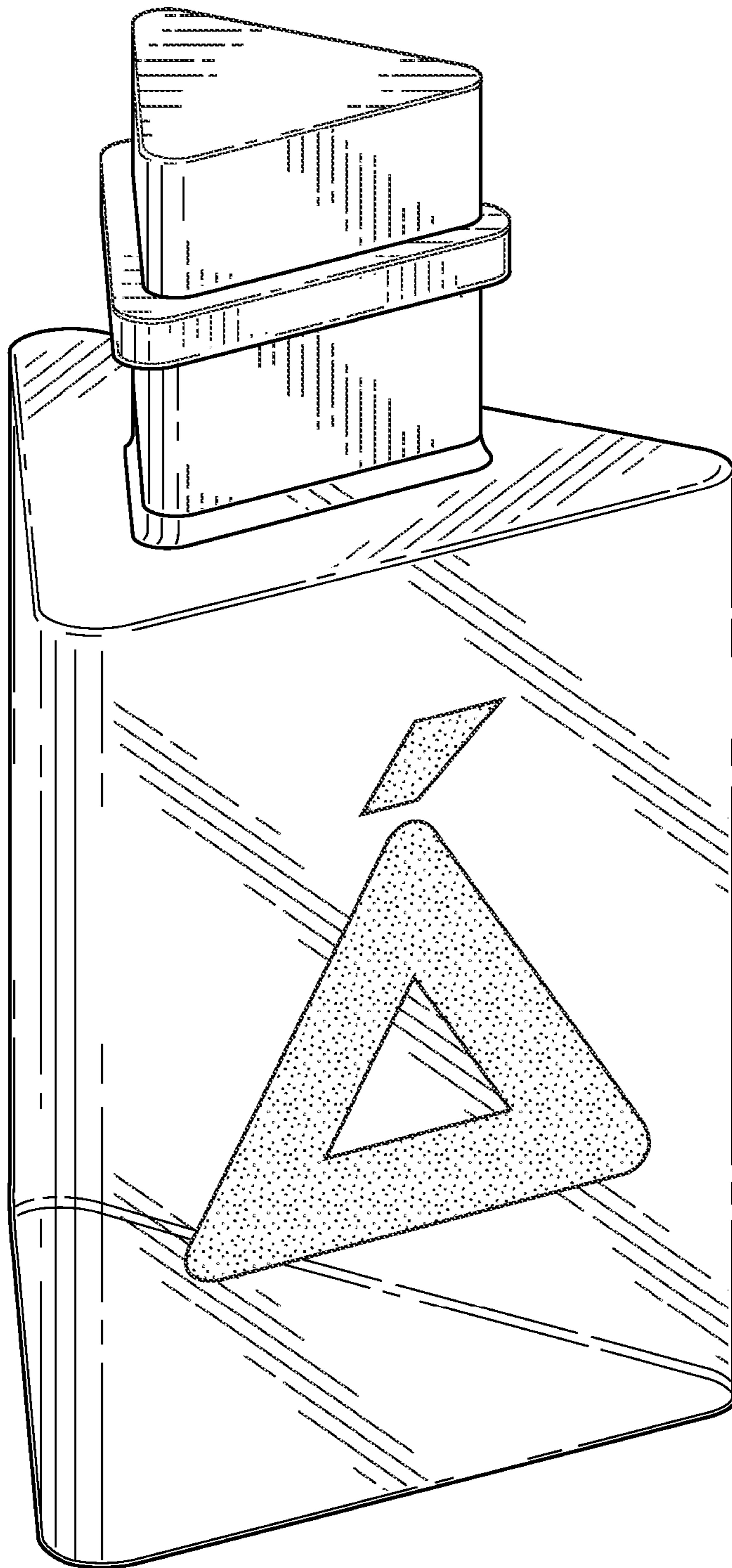

FIG. 1

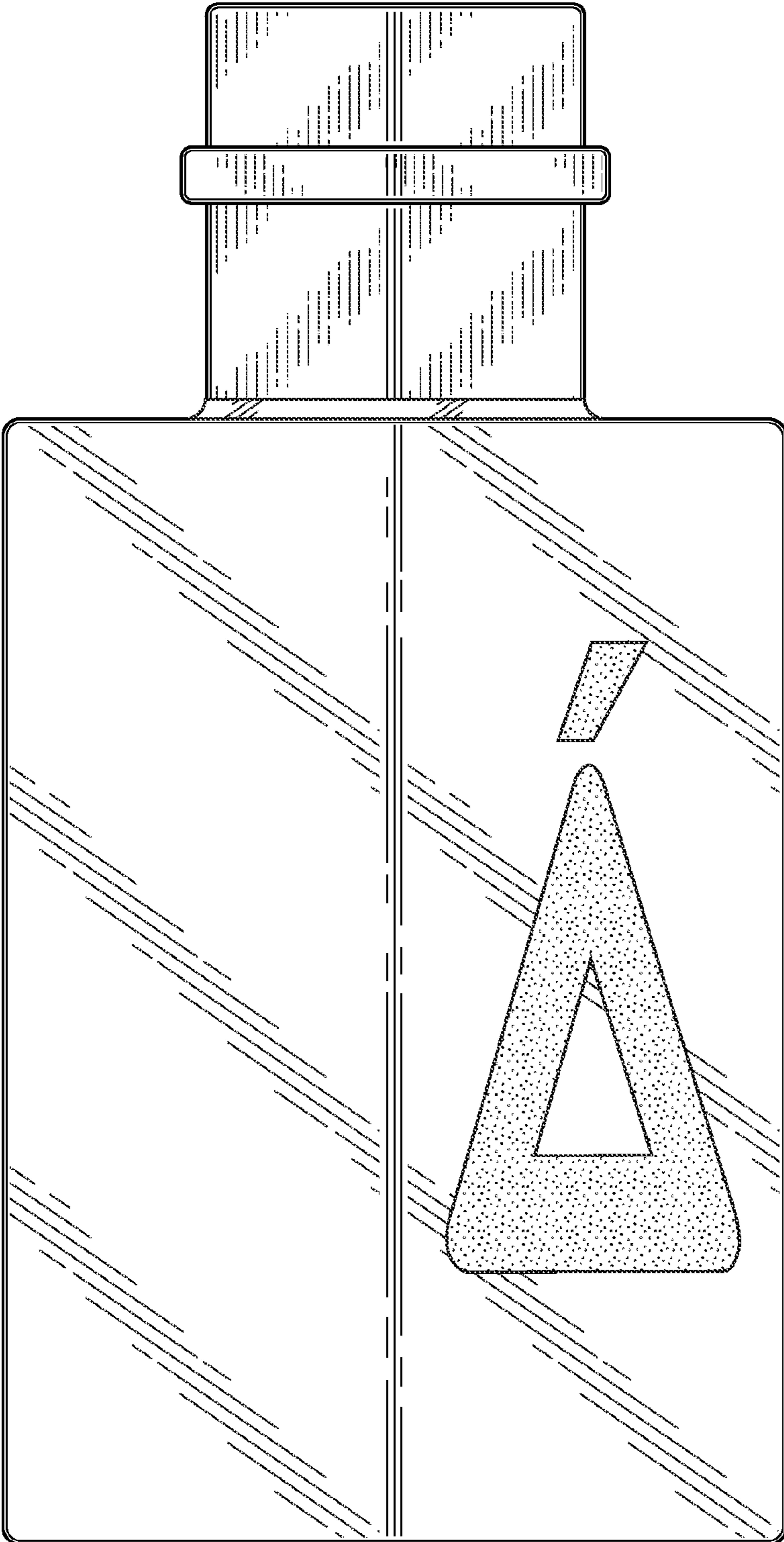

FIG. 2

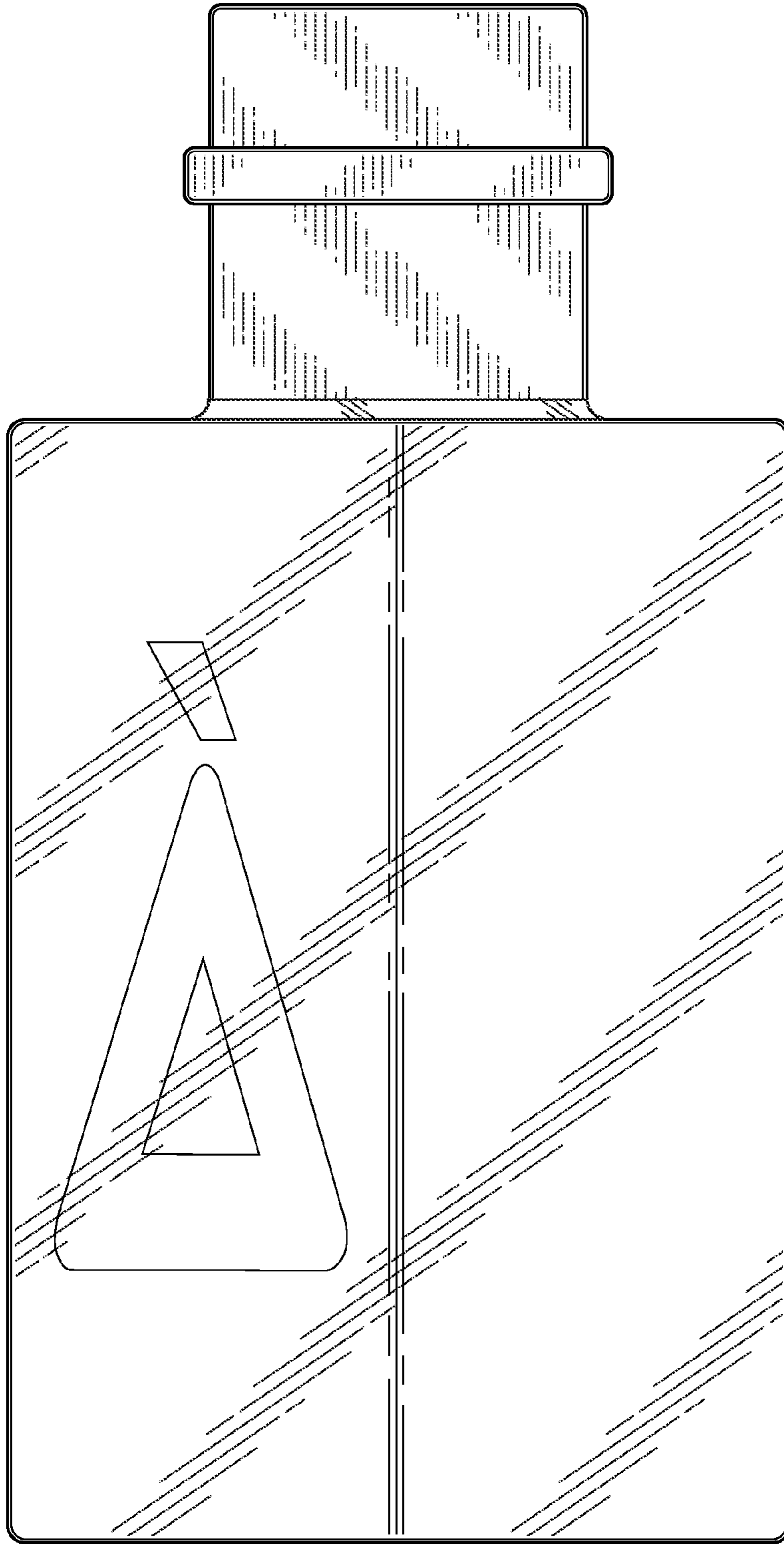

FIG. 3

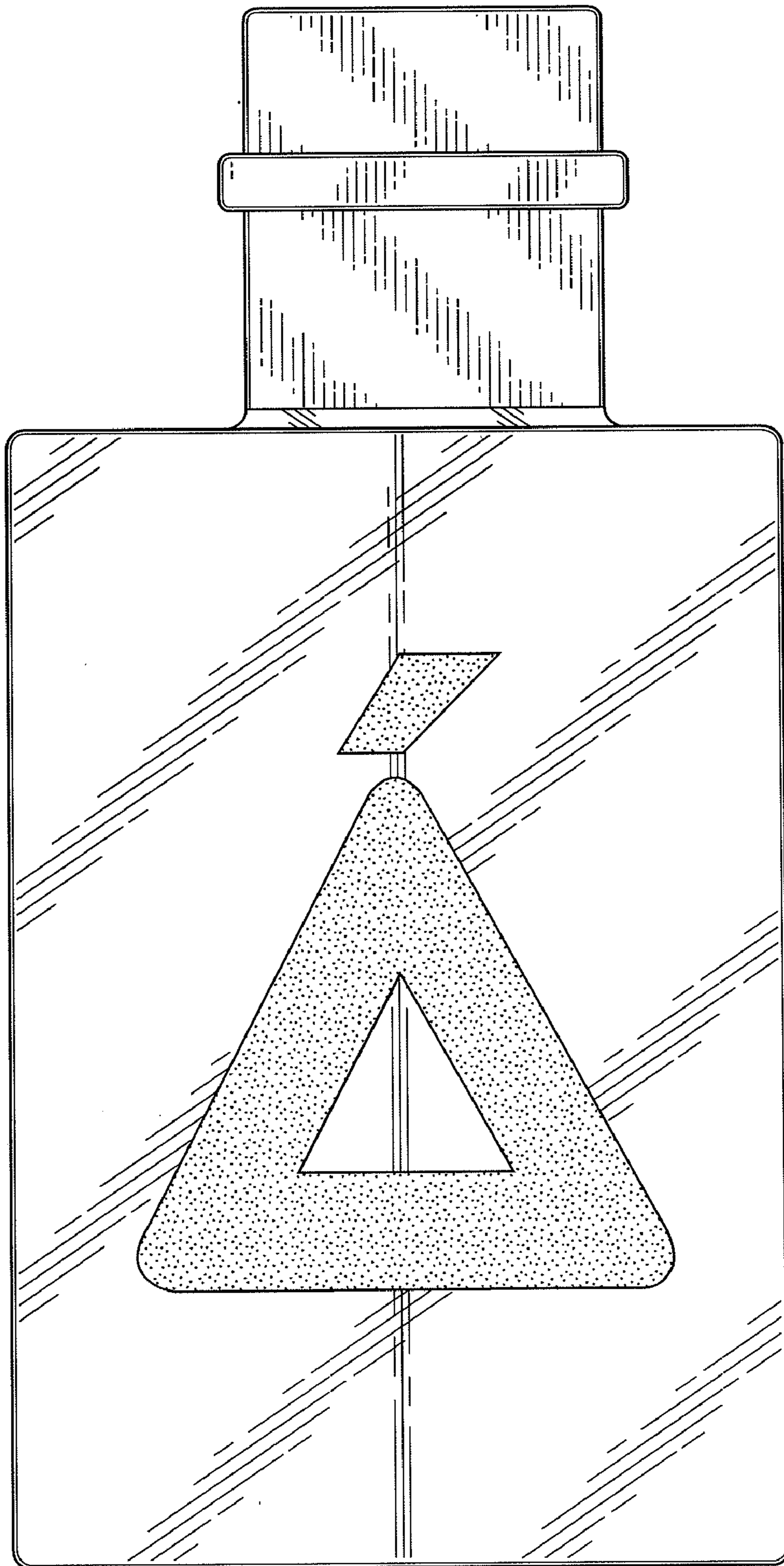

FIG. 4

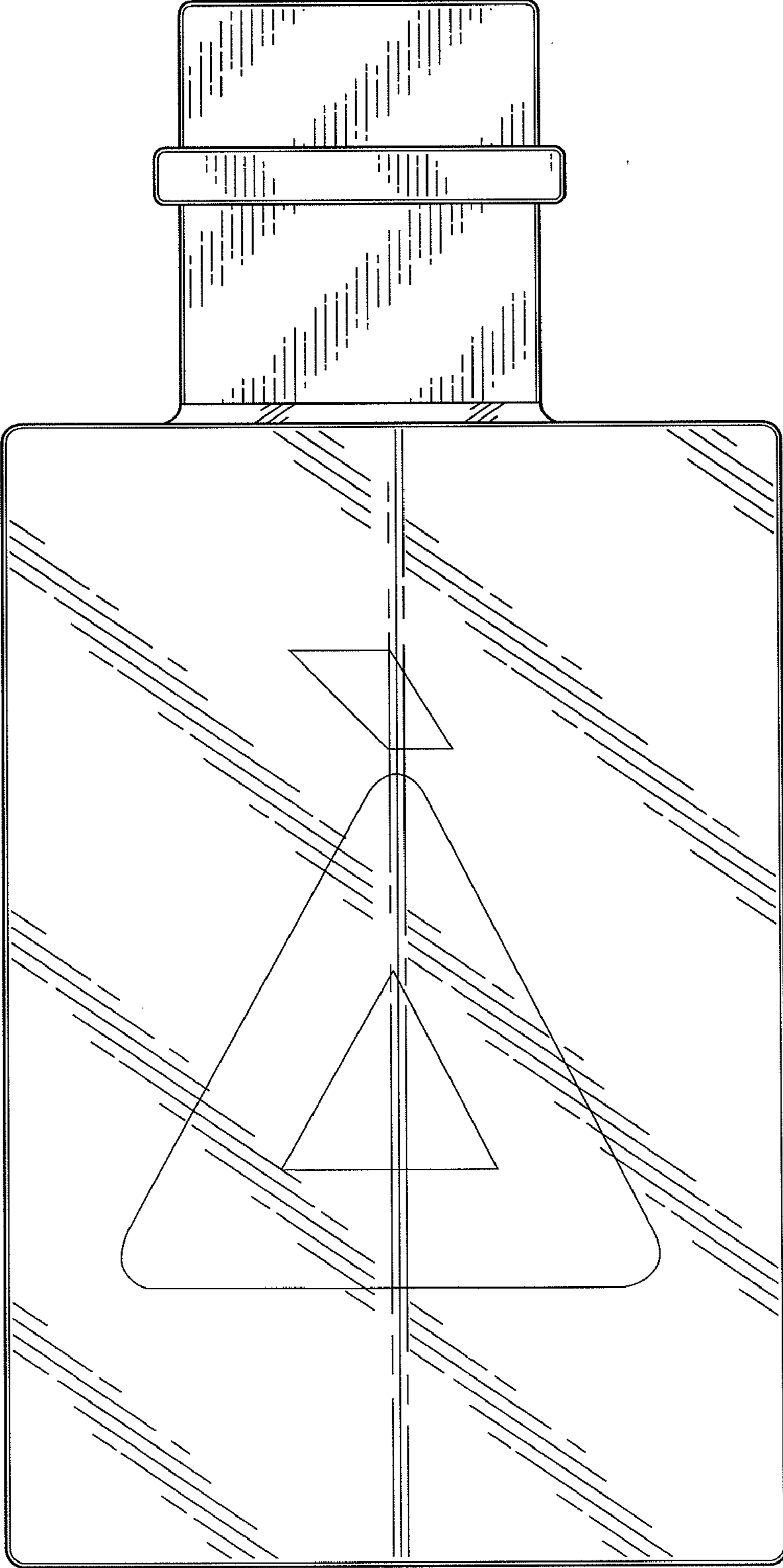

FIG. 5

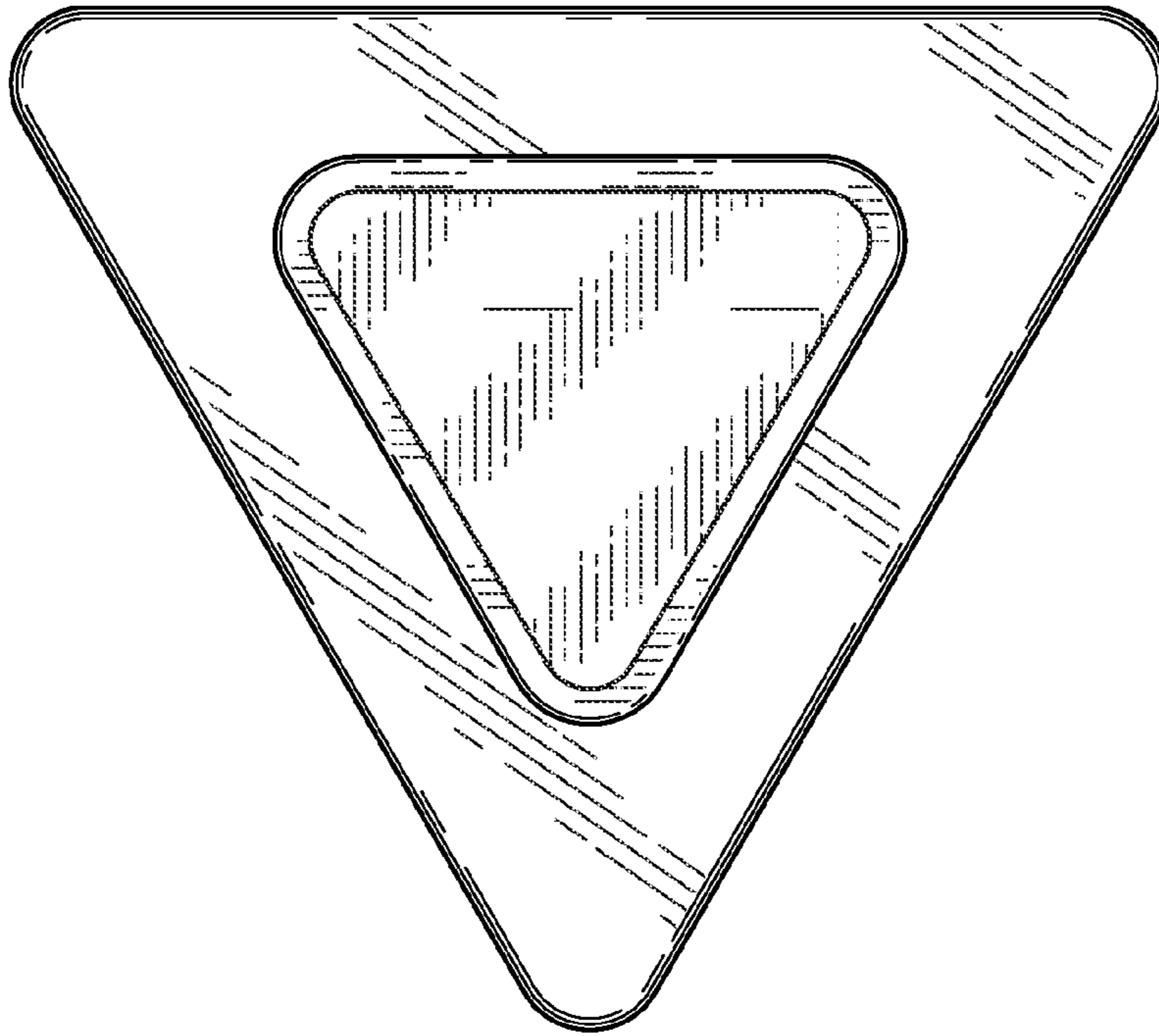

FIG. 6

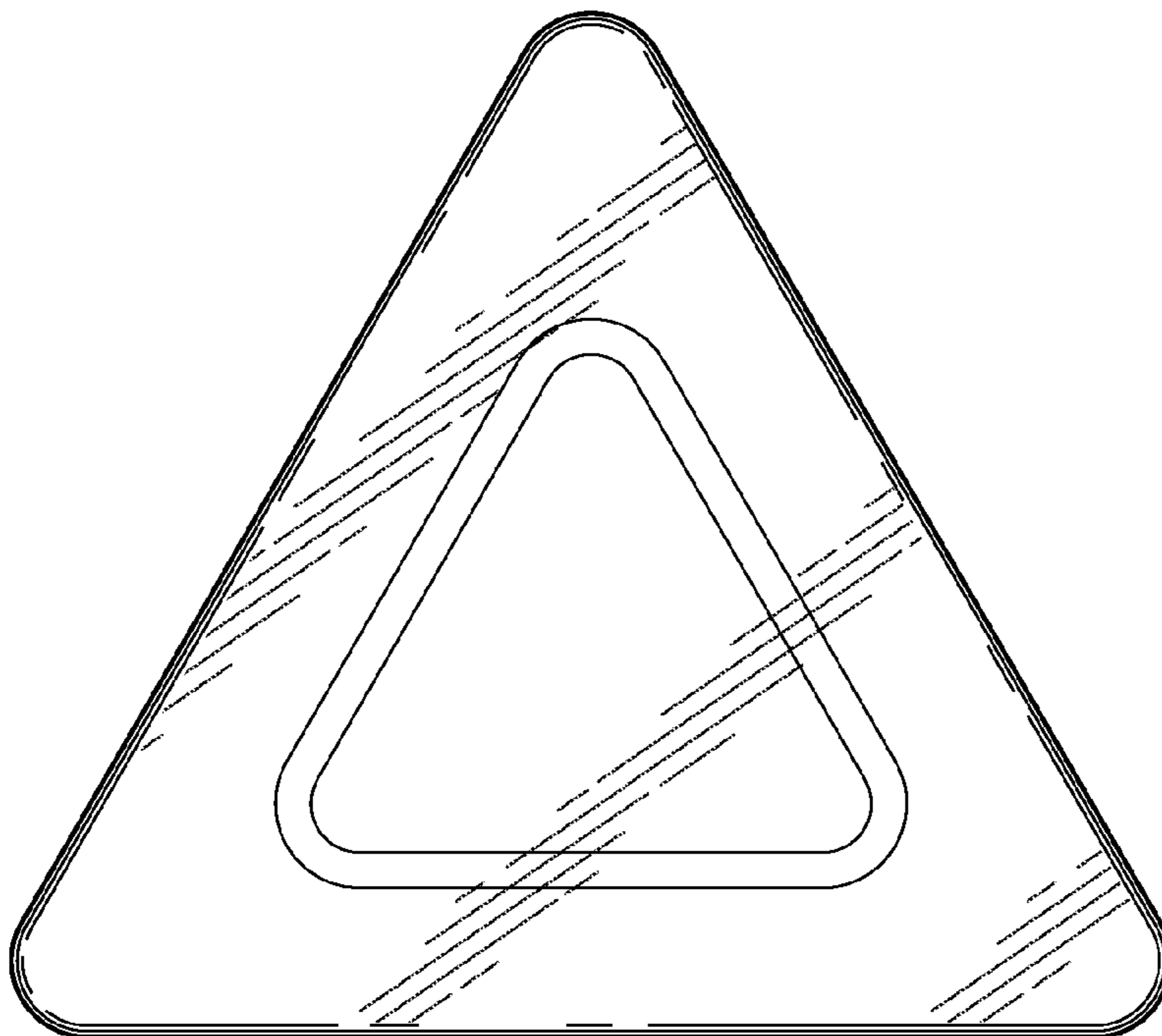

FIG. 7