



US00D624394S

(12) **United States Design Patent**  
**Domek et al.**

(10) **Patent No.:** **US D624,394 S**

(45) **Date of Patent:** **\*\* Sep. 28, 2010**

(54) **PULL-DOWN PLANT HANGER**

(76) Inventors: **Pamela J. Domek**, 709 N. 8<sup>TH</sup> St.,  
Estherville, IA (US) 51334; **Robert M. Carter**, 108 N. 16<sup>TH</sup> St., Estherville, IA  
(US) 51334

(\*\*) Term: **14 Years**

(21) Appl. No.: **29/350,970**

(22) Filed: **Nov. 25, 2009**

(51) **LOC (9) Cl.** ..... **08-05**

(52) **U.S. Cl.** ..... **D8/373**

(58) **Field of Classification Search** ..... D8/373,  
D8/367; 248/301–304; D6/513; 47/67  
See application file for complete search history.

(56) **References Cited**

U.S. PATENT DOCUMENTS

4,384,687	A	5/1983	Lamoureux	
D270,796	S	* 10/1983	Quirico	..... D6/513
D286,961	S	* 12/1986	Abrams	..... D6/513
4,635,755	A	1/1987	Arechaga	

OTHER PUBLICATIONS

Wikipedia [online] [retrieved Nov. 18, 2009]. Retrieved from the internet: <[http://en.wikipedia.org/wiki/Constant-force\\_spring](http://en.wikipedia.org/wiki/Constant-force_spring)>.

\* cited by examiner

*Primary Examiner*—Holly H Baynham  
(74) *Attorney, Agent, or Firm*—McKee, Voorhees & Sease, P.L.C.

(57) **CLAIM**

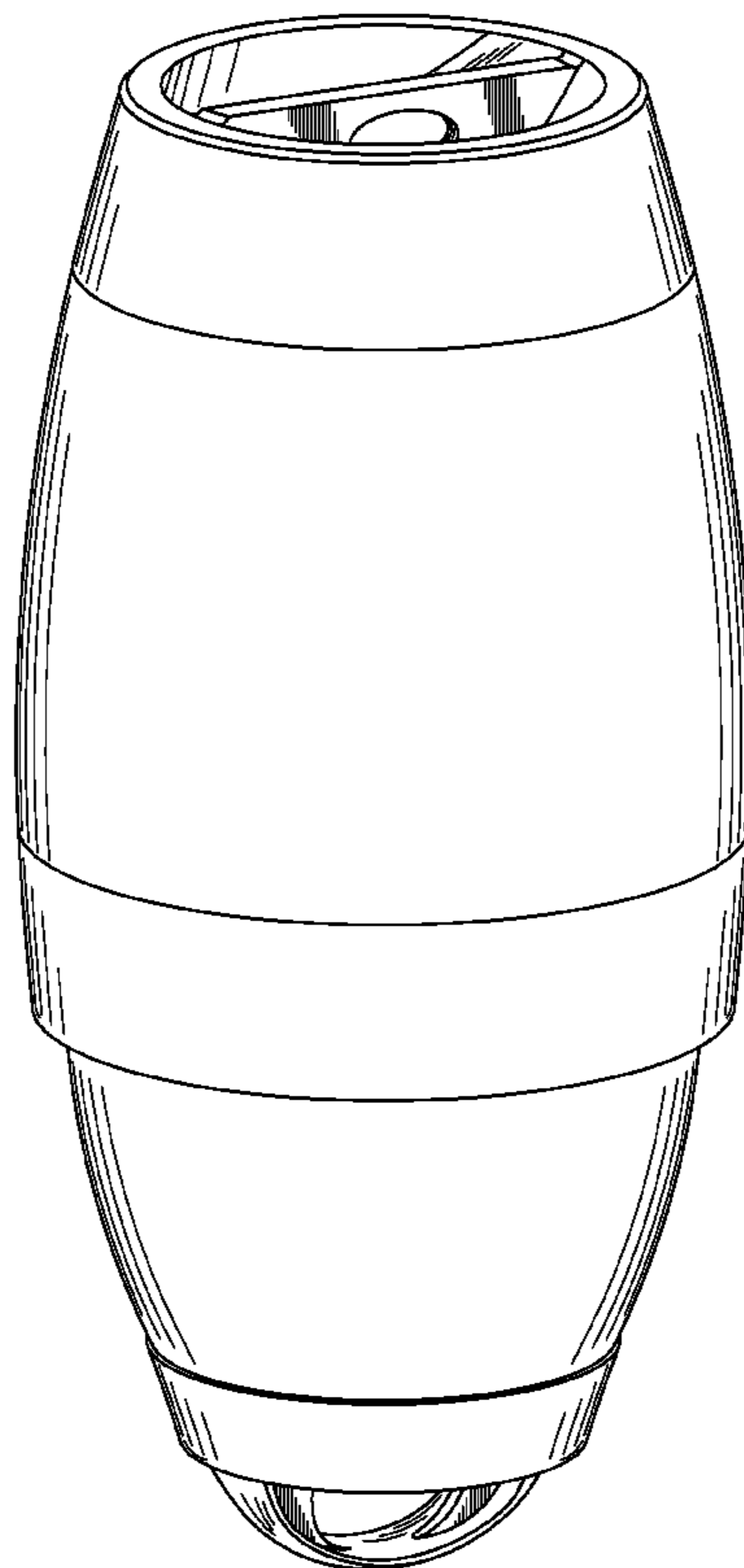
We claim the ornamental design for a pull-down plant hanger, substantially as shown and described.

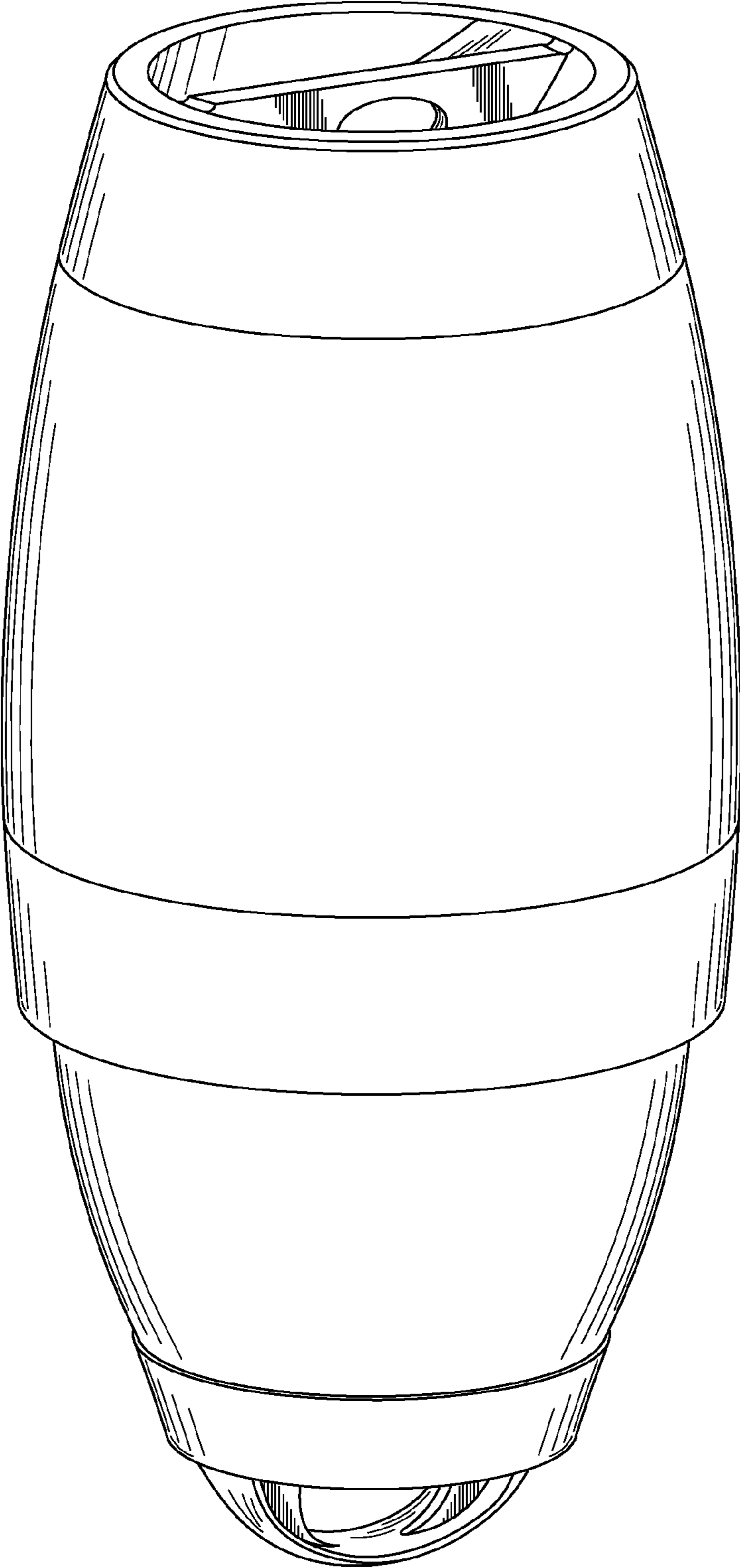
**DESCRIPTION**

FIG. 1 is a perspective view of the invention.  
FIG. 2 is a front elevation view of FIG. 1.  
FIG. 3 is a back elevation view of FIG. 1.  
FIG. 4 is a side elevation of FIG. 1.  
FIG. 5 is an opposite side elevation of FIG. 1.  
FIG. 6 is a top plan view of FIG. 1.  
FIG. 7 is a bottom plan view of FIG. 1; and,  
FIG. 8 is a reduced-in-scale front elevation of the invention showing in broken lines an exemplary environment with which the invention might be used.

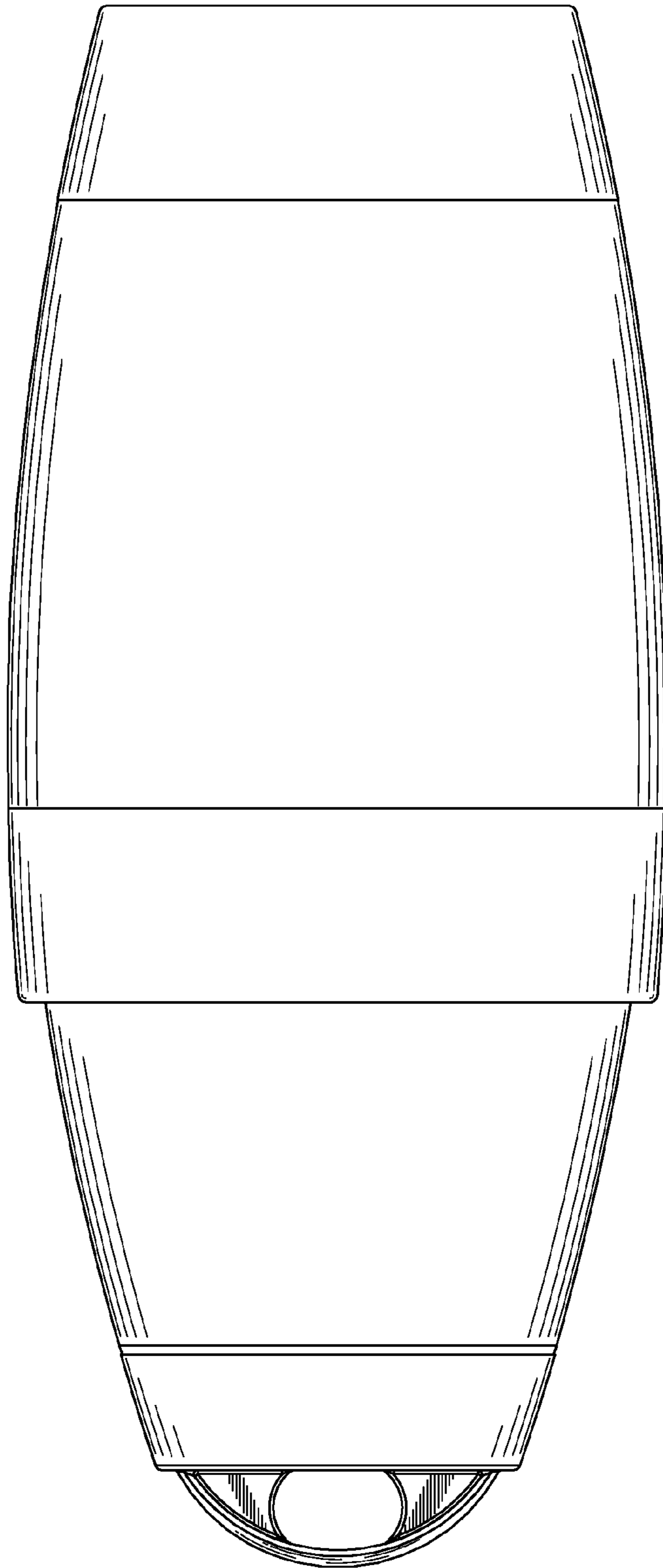
The broken lines showing a partial wall and a pot of flowers is for illustrative purposes only and forms no part of the claimed design.

**1 Claim, 8 Drawing Sheets**

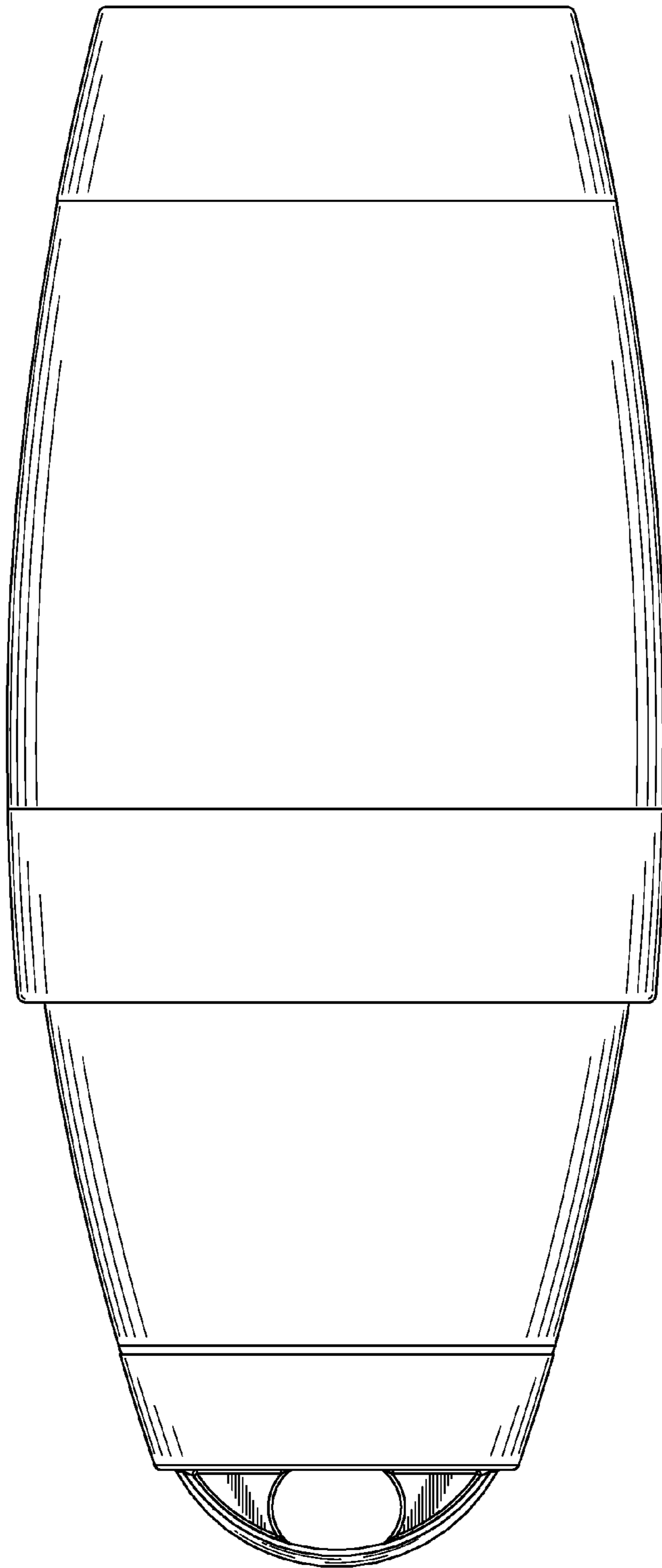




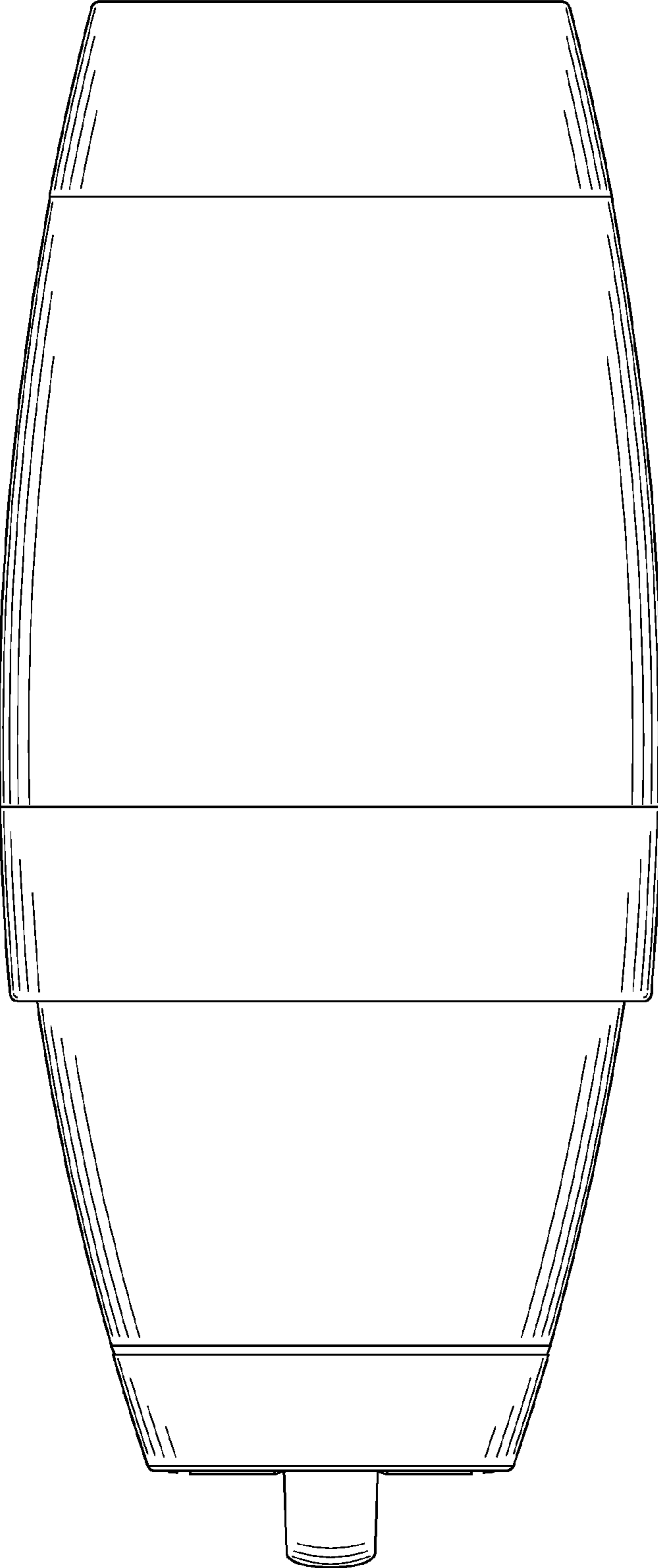
*Fig. 1*



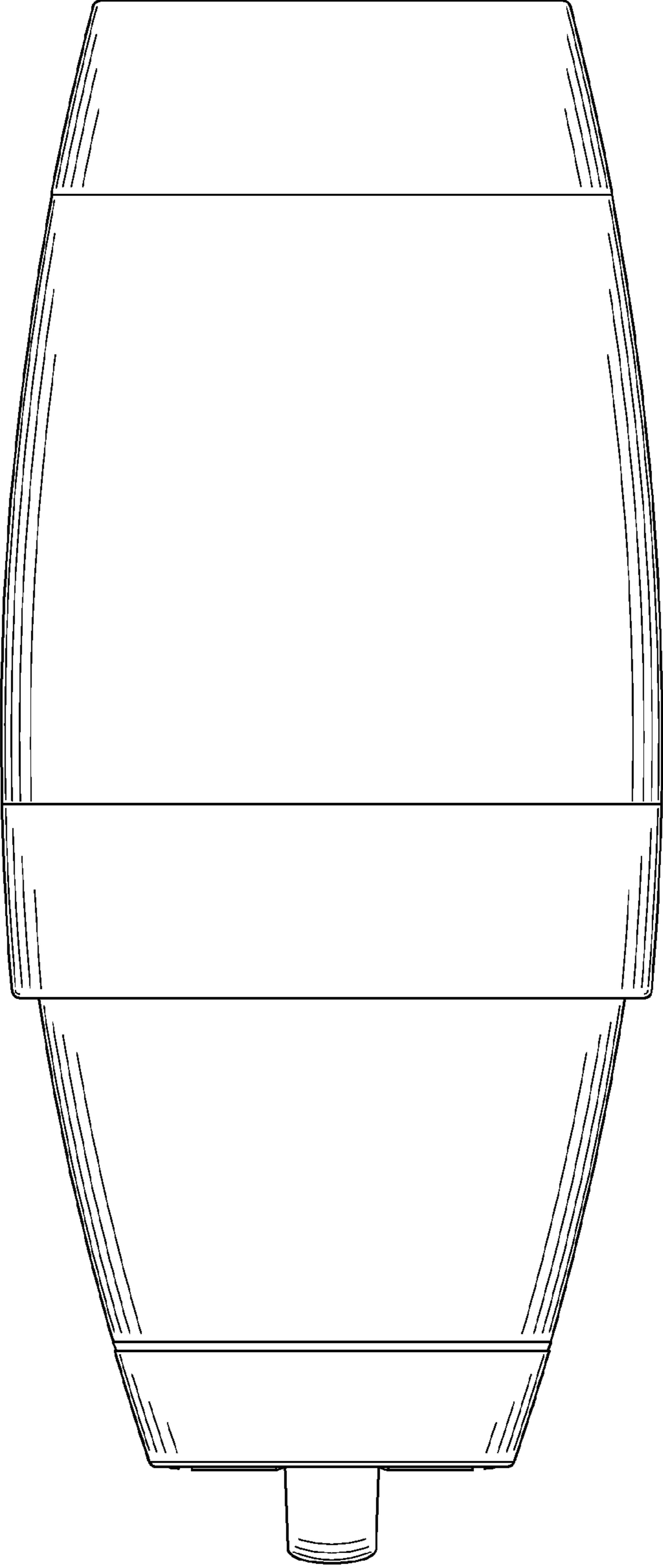
*Fig. 2*



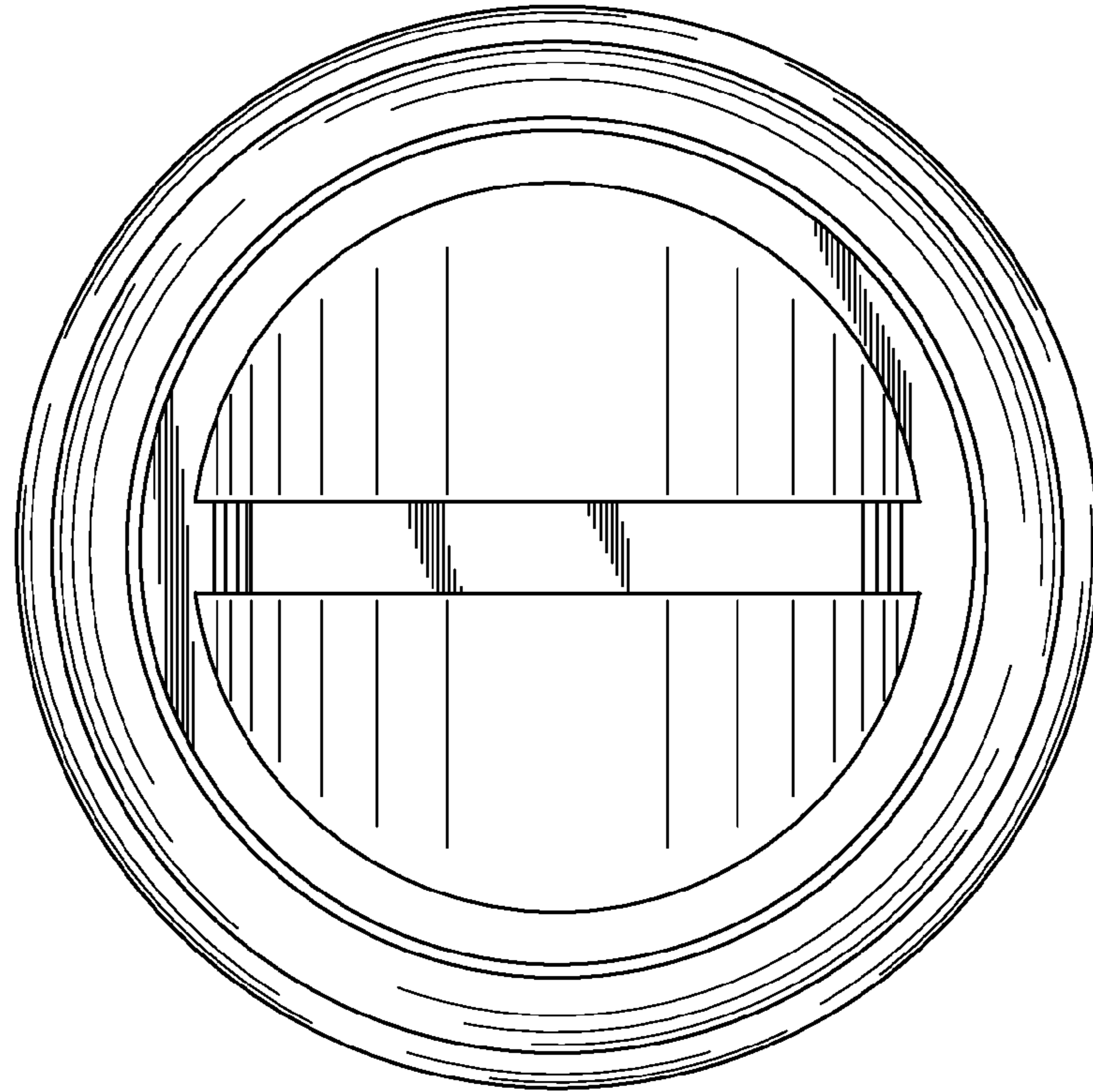
*Fig. 3*



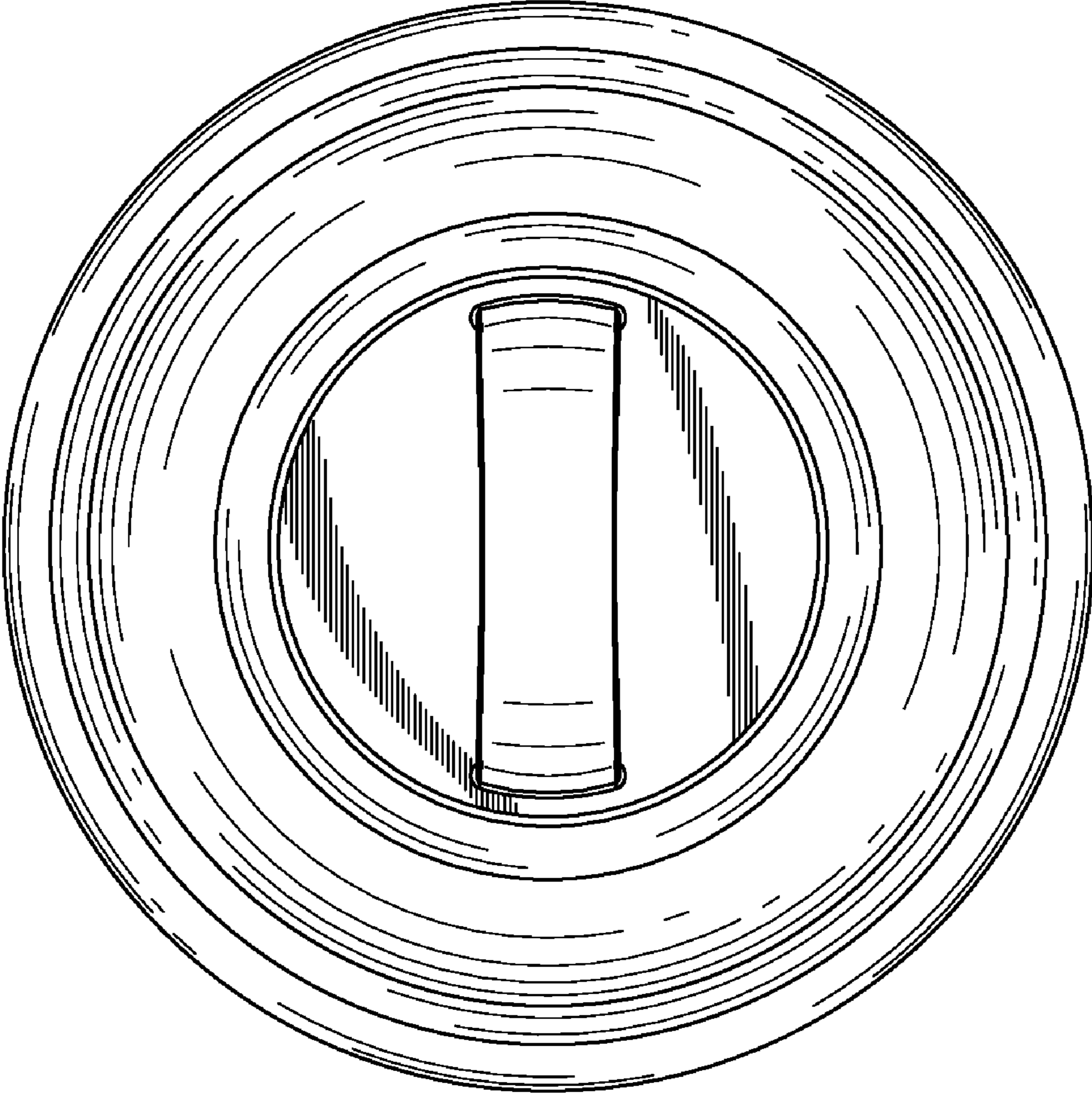
*Fig. 4*



*Fig. 5*

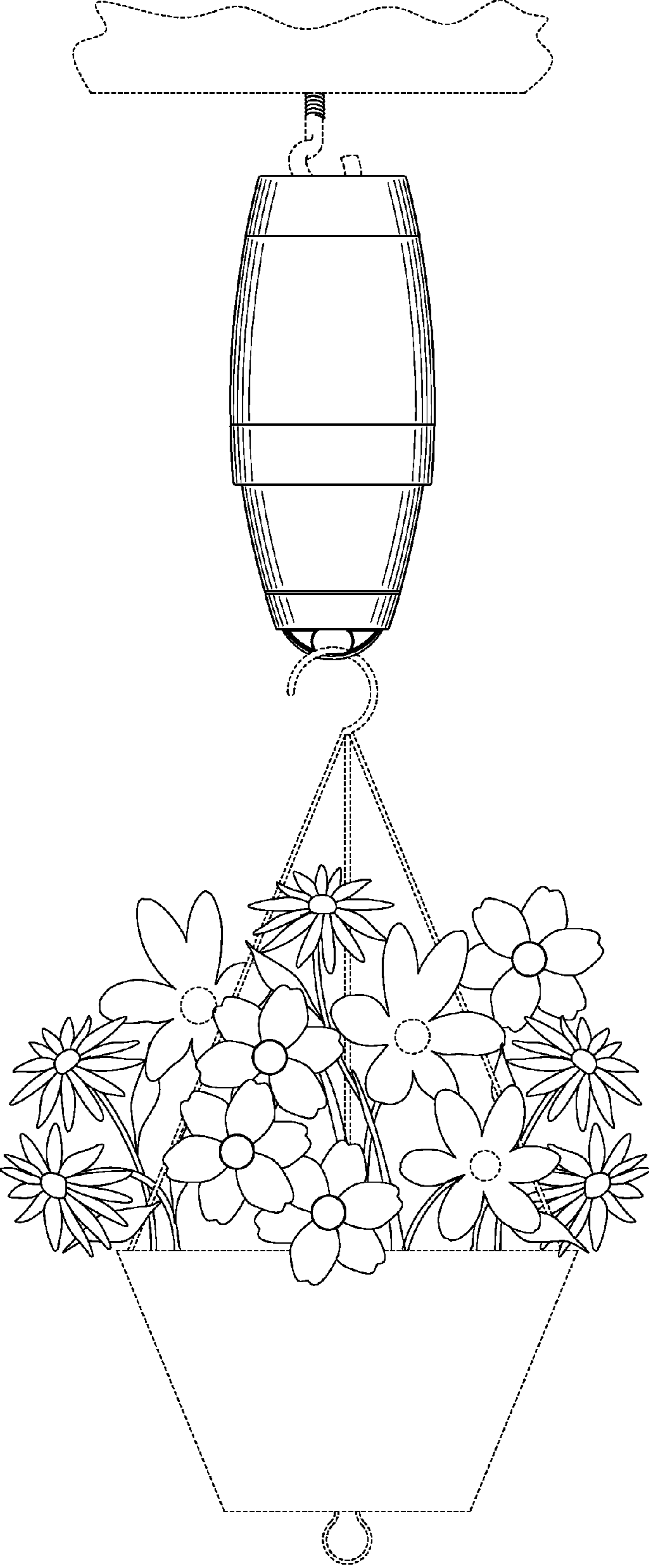


*Fig. 6*



*Fig. 7*





*Fig. 8*