



US00D624379S

(12) **United States Design Patent**
Pantoja

(10) **Patent No.:** **US D624,379 S**

(45) **Date of Patent:** **** Sep. 28, 2010**

(54) **CUTTING TOOL**

(76) **Inventor:** **Art Pantoja**, 1201 Glen Cove Pkwy.,
#207, Vallejo, CA (US) 94591

(**) **Term:** **14 Years**

(21) **Appl. No.:** **29/349,080**

(22) **Filed:** **Mar. 4, 2010**

(51) **LOC (9) Cl.** **08-05**

(52) **U.S. Cl.** **D8/52**

(58) **Field of Classification Search** D8/1,
D8/4, 5, 14, 20, 51-56, 58, 105-107; 30/158-161,
30/236, 262, 131-135, 173, 184, 186, 188,
30/192-194, 233, 244-254, 258, 260; 72/409.01-409.09,
72/409.1-409.19, 407, 408; D17/20, 99
See application file for complete search history.

(56) **References Cited**

U.S. PATENT DOCUMENTS

D116,745	S	*	9/1939	Mayer	D8/58
2,760,390	A	*	8/1956	Ayer	30/233
3,178,926	A	*	4/1965	Logan	72/409.14
D214,712	S	*	7/1969	Black	D8/58
D215,809	S	*	11/1969	Baun	D8/52
D220,309	S	*	3/1971	Baun	D8/52
D226,548	S	*	3/1973	Burgeson	D8/58
D229,022	S	*	11/1973	Freedman	D8/52
3,893,199	A	*	7/1975	Todaro	7/107
4,070,898	A	*	1/1978	Earle	72/409.13
D251,409	S	*	3/1979	Smith	D8/58
4,246,698	A	*	1/1981	Lasner et al.	30/134
D259,695	S	*	6/1981	Byberg et al.	D8/58
4,271,593	A	*	6/1981	Smith	30/233

D260,132	S	*	8/1981	Shaffer	D8/52
D272,707	S	*	2/1984	Shaffer	D8/52
D272,984	S	*	3/1984	Shaffer	D8/52
4,918,815	A	*	4/1990	Juros	30/191
D327,310	S	*	6/1992	Dudley	D22/119
D355,574	S	*	2/1995	Fuller	D8/52
7,434,314	B2	*	10/2008	Morton	29/897.31
D603,665	S	*	11/2009	Trewartha et al.	D8/5

* cited by examiner

Primary Examiner—Cathron C Brooks
Assistant Examiner—Deanna Fluegeman
(74) *Attorney, Agent, or Firm*—Howard Cohen

(57) **CLAIM**

The ornamental design for a cutting tool, as shown and described.

DESCRIPTION

FIG. 1 is a perspective view of a cutting tool showing my new design.

FIG. 2 is a bottom perspective view.

FIG. 3 is a right side perspective view, the left side being a mirror image thereof.

FIG. 4 is top perspective view.

FIG. 5 is front perspective view.

FIG. 6 is rear perspective view; and,

FIG. 7 is a perspective view opened in the environment.

The broken lines in the drawings illustrate unclaimed environment and form no part of the claimed design.

1 Claim, 2 Drawing Sheets

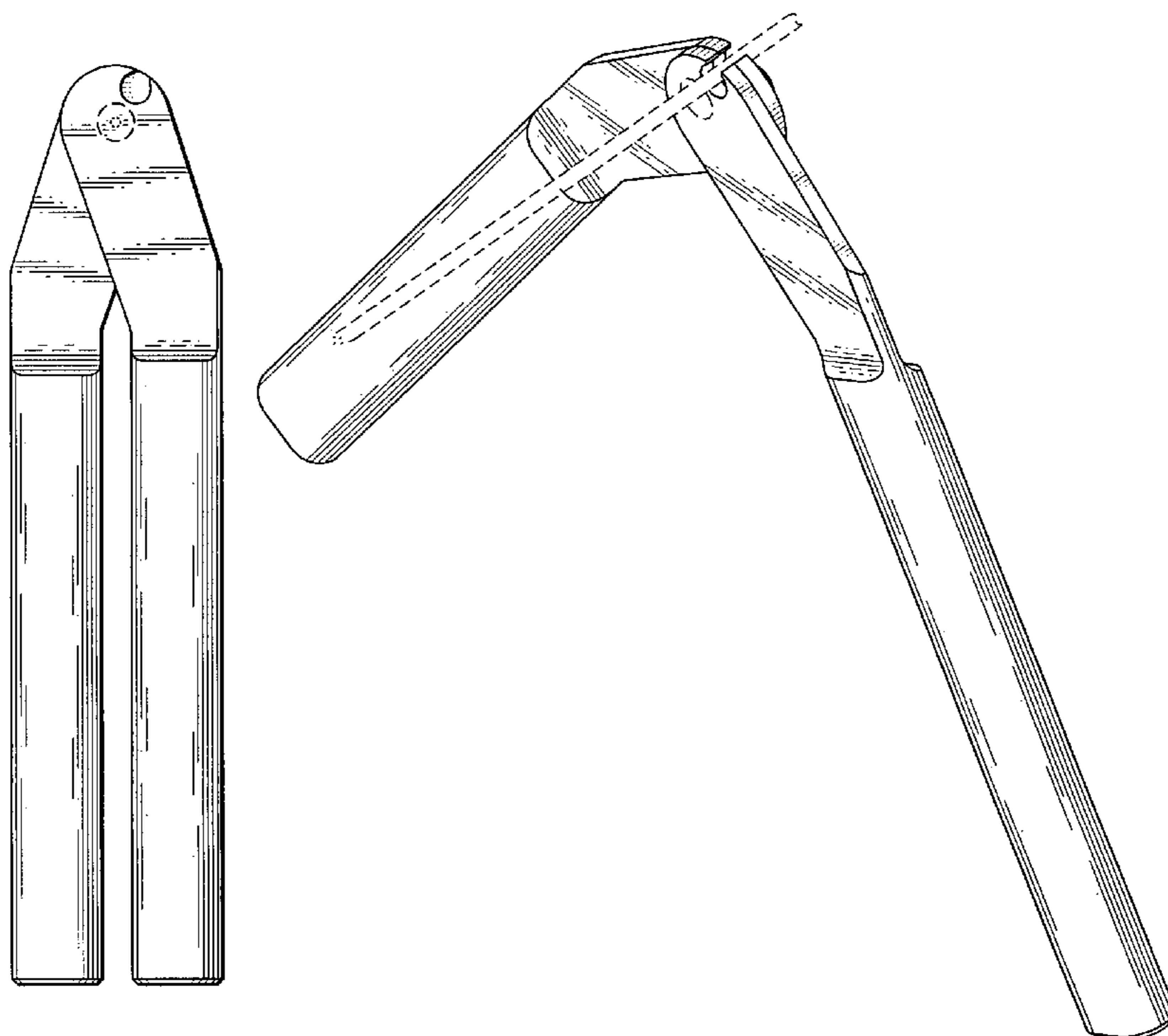

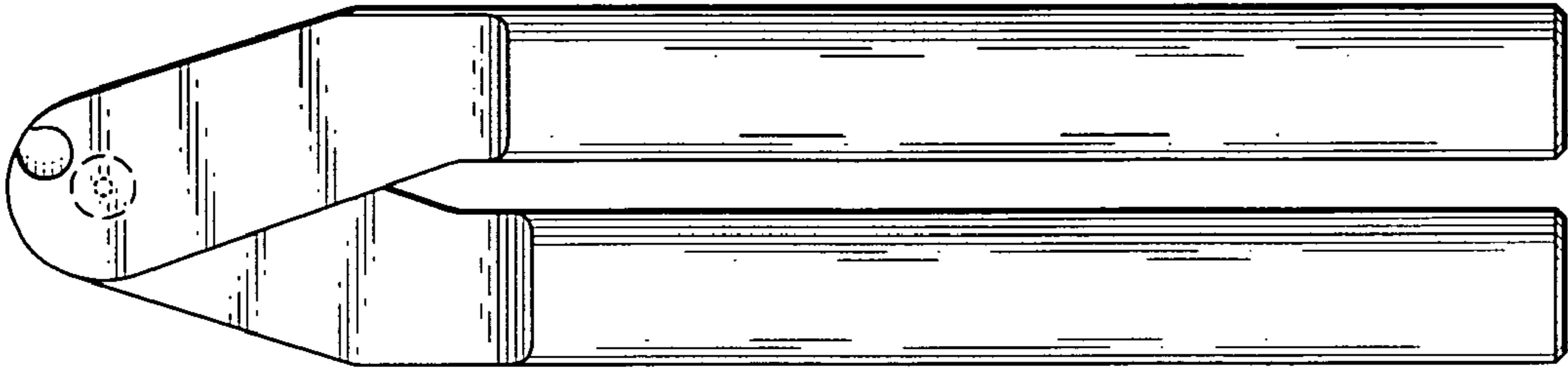

Fig. 4

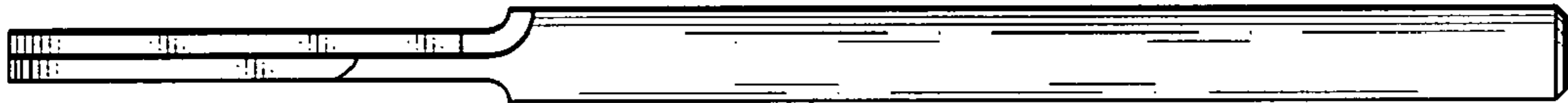

Fig. 3

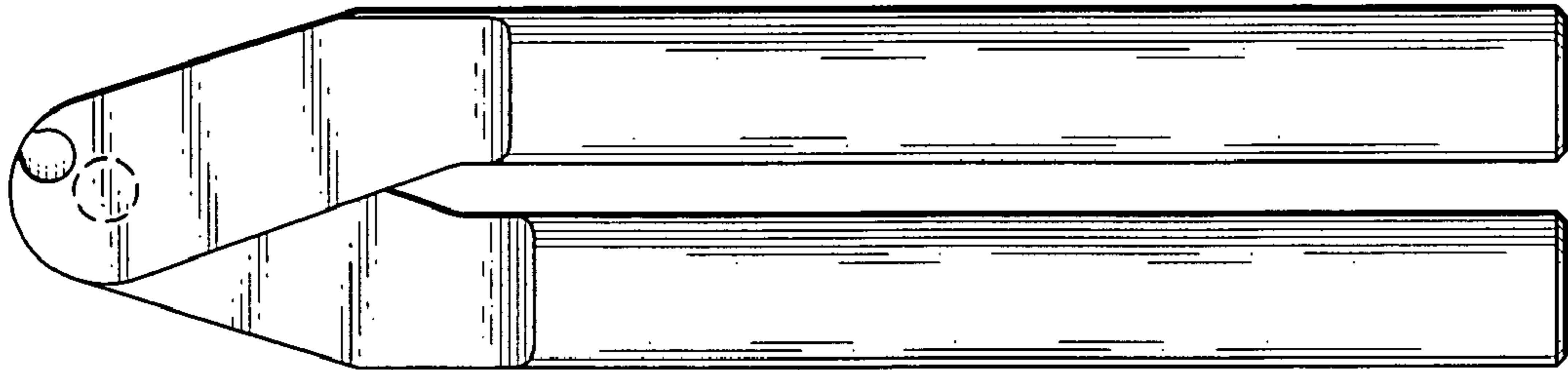

Fig. 2

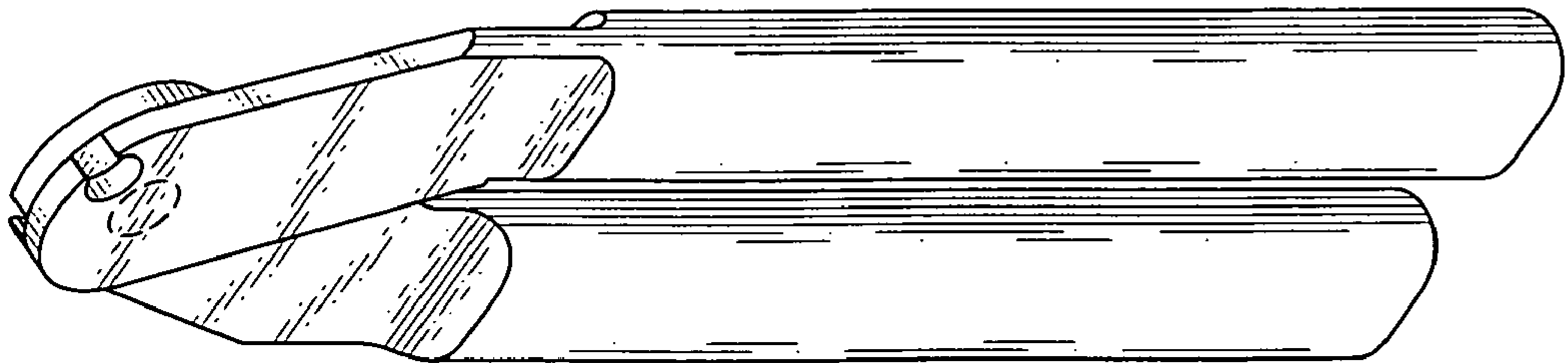

Fig. 1

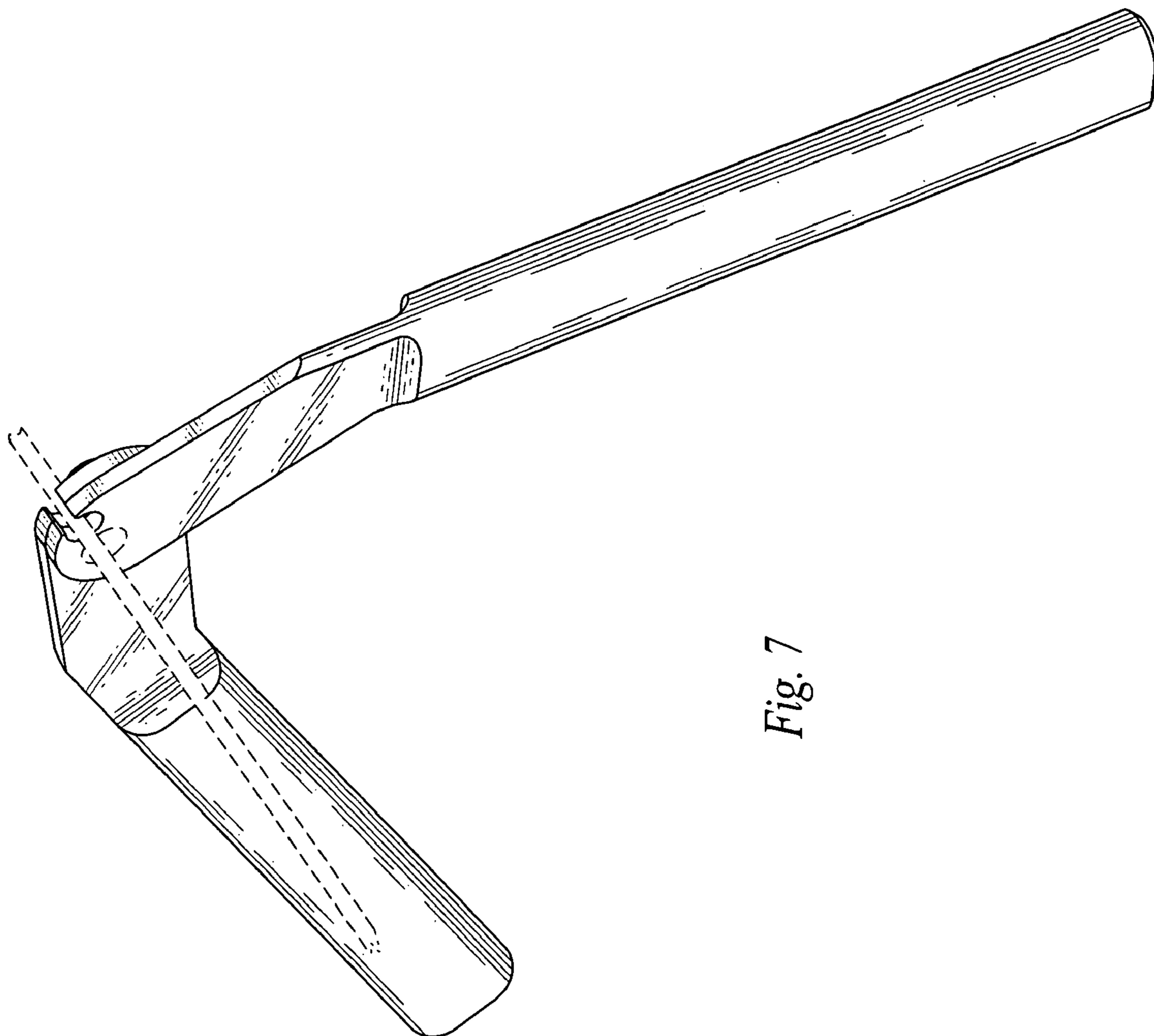

Fig. 7

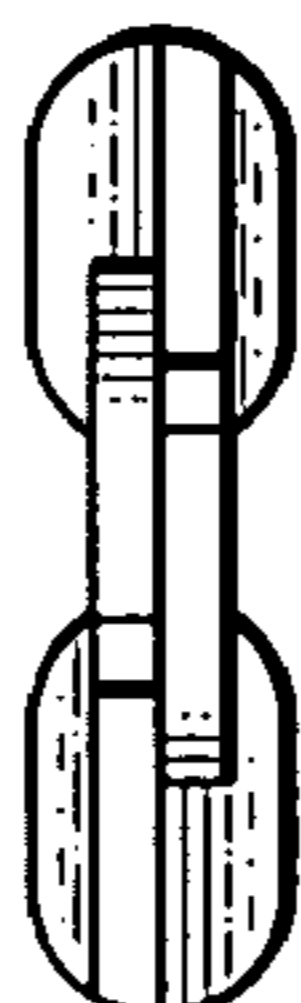

Fig. 5

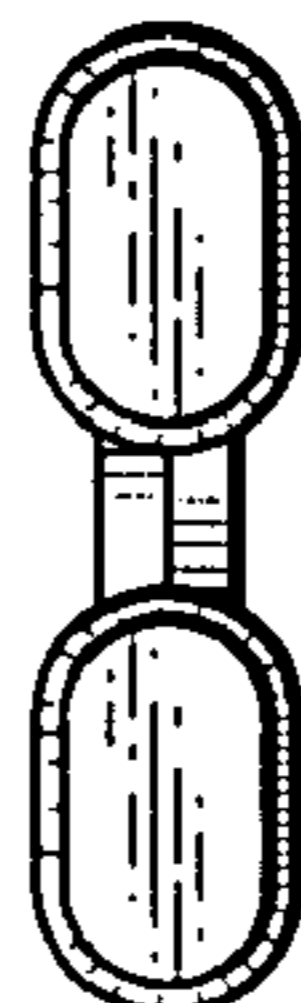

Fig. 6