



US00D624333S

(12) **United States Design Patent**  
**Okuda**

(10) **Patent No.:** **US D624,333 S**  
(45) **Date of Patent:** **\*\* Sep. 28, 2010**

(54) **SHOWCASE**

(75) Inventor: **Yu Okuda**, Toyoake (JP)

(73) Assignee: **Hoshizaki Denki Kabushiki Kaisha**,  
Aichi-Ken (JP)

(\*\*) Term: **14 Years**

(21) Appl. No.: **29/337,074**

(22) Filed: **May 14, 2009**

(30) **Foreign Application Priority Data**

Apr. 13, 2009	(JP)	.....	2009-008400
Apr. 13, 2009	(JP)	.....	2009-008401
Apr. 13, 2009	(JP)	.....	2009-008406
Apr. 13, 2009	(JP)	.....	2009-008408

(51) **LOC (9) Cl.** ..... **06-04**

(52) **U.S. Cl.** ..... **D6/472**

(58) **Field of Classification Search** ..... D6/396,  
D6/397, 436, 470, 471, 472, 475, 476, 479;  
312/114, 116, 117, 138.1, 204, 236, 237,  
312/401, 404, 405, 407, 407.1; D15/79,  
D15/81-85; 62/246, 440, 444, 445, 449

See application file for complete search history.

(56) **References Cited**

**U.S. PATENT DOCUMENTS**

D147,818 S \* 11/1947 Silveira ..... D6/472

(Continued)

*Primary Examiner*—Mimosa De

(74) *Attorney, Agent, or Firm*—Osha Liang LLP

(57) **CLAIM**

The ornamental design for a showcase, as shown and described.

**DESCRIPTION**

FIG. 1 is a perspective view of the front, right and top of a showcase according to a first embodiment showing my new design;

FIG. 2 is a front view thereof;

FIG. 3 is a right side view thereof;

FIG. 4 is a rear view thereof;

FIG. 5 is a left side view thereof;

FIG. 6 is a top plan view thereof;

FIG. 7 is a bottom view thereof;

FIG. 8 is a perspective view of the front, left and top of a showcase according to a second embodiment showing my new design;

FIG. 9 is a front view thereof;

FIG. 10 is a right side view thereof;

FIG. 11 is a rear view thereof;

FIG. 12 is a left side view thereof;

FIG. 13 is a top plan view thereof;

FIG. 14 is a bottom view thereof;

FIG. 15 is a perspective view of the front, right and top of a showcase according to a third embodiment showing my new design;

FIG. 16 is a front view thereof;

FIG. 17 is a right side view thereof;

FIG. 18 is a rear view thereof;

FIG. 19 is a left side view thereof;

FIG. 20 is a top plan view thereof;

FIG. 21 is a bottom view thereof;

FIG. 22 is a perspective view of the front, right and top of a showcase according to a fourth embodiment showing my new design;

FIG. 23 is front view thereof;

FIG. 24 is a right side view thereof;

FIG. 25 is a rear view thereof;

FIG. 26 is a left side view thereof;

FIG. 27 is a top plan view thereof; and,

FIG. 28 is a bottom view thereof.

**1 Claim, 19 Drawing Sheets**

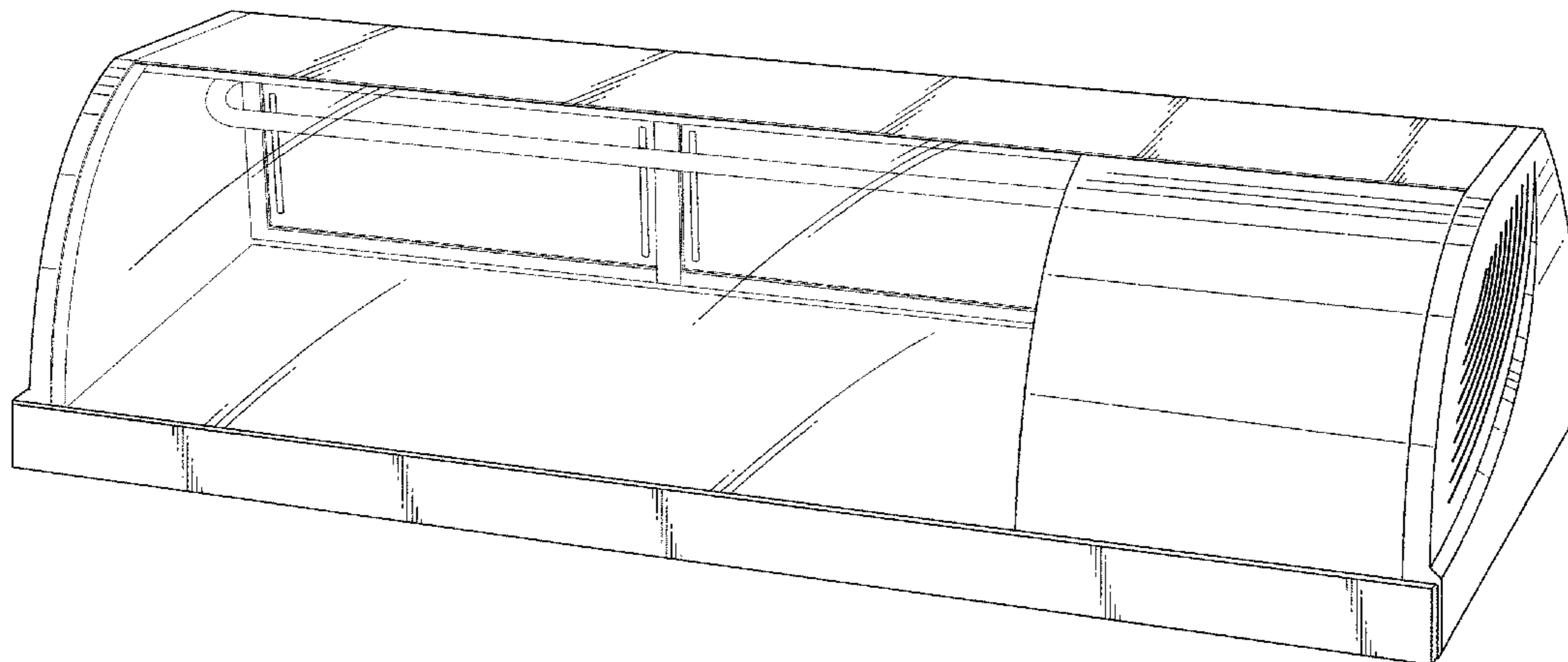

# US D624,333 S

Page 2

---

## U.S. PATENT DOCUMENTS

D268,069 S *	3/1983	Milstein .....	D6/472	D351,298 S *	10/1994	Gelinas .....	D6/472
D290,667 S *	7/1987	De Zolt .....	D6/472	D413,459 S *	9/1999	Evdokimoff .....	D6/472
D291,850 S *	9/1987	Perkins et al. ....	D6/471	D471,738 S *	3/2003	Hohler et al. ....	D6/471
D303,595 S *	9/1989	Thompson et al. ....	D6/472	D478,744 S *	8/2003	Ohtake .....	D6/471
D350,658 S *	9/1994	Graat .....	D6/471	D499,280 S *	12/2004	Ohtake .....	D6/471
				D591,532 S *	5/2009	Kim .....	D6/472

\* cited by examiner

FIG.1

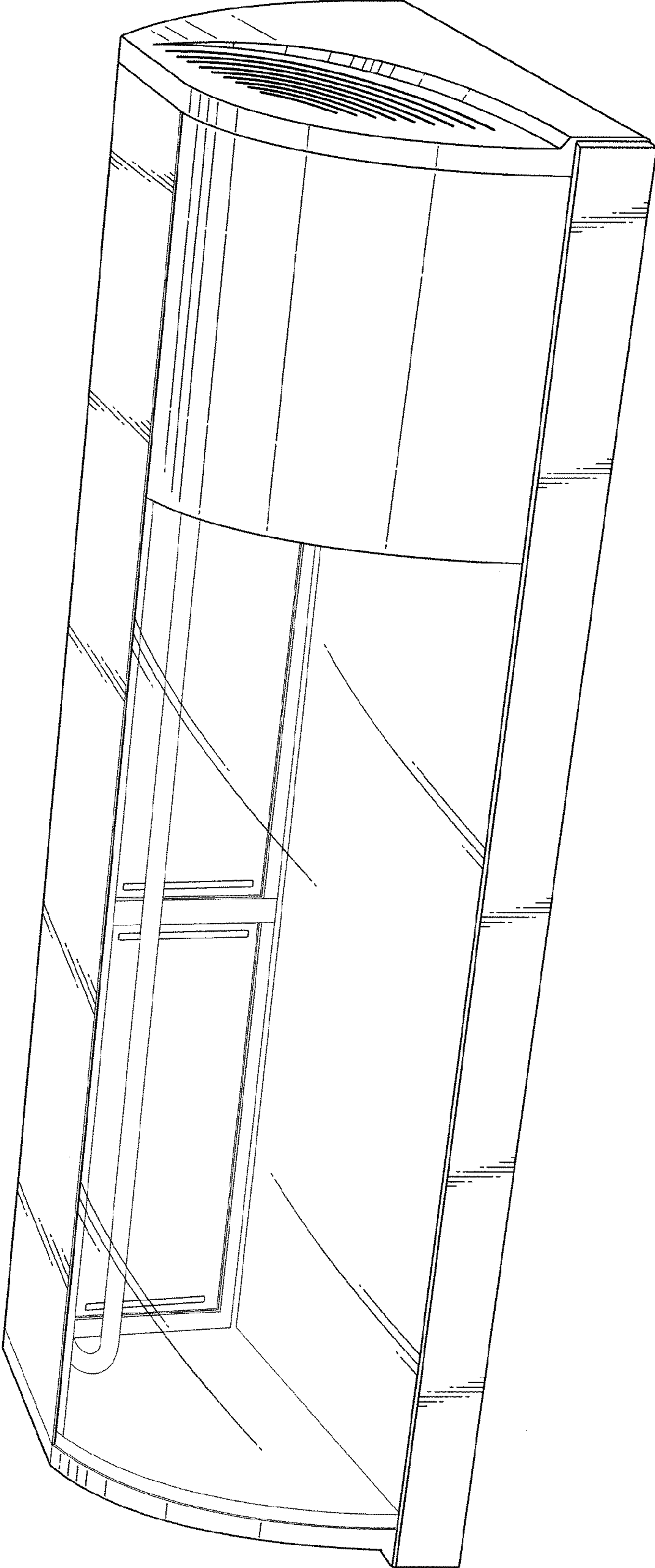

FIG.2

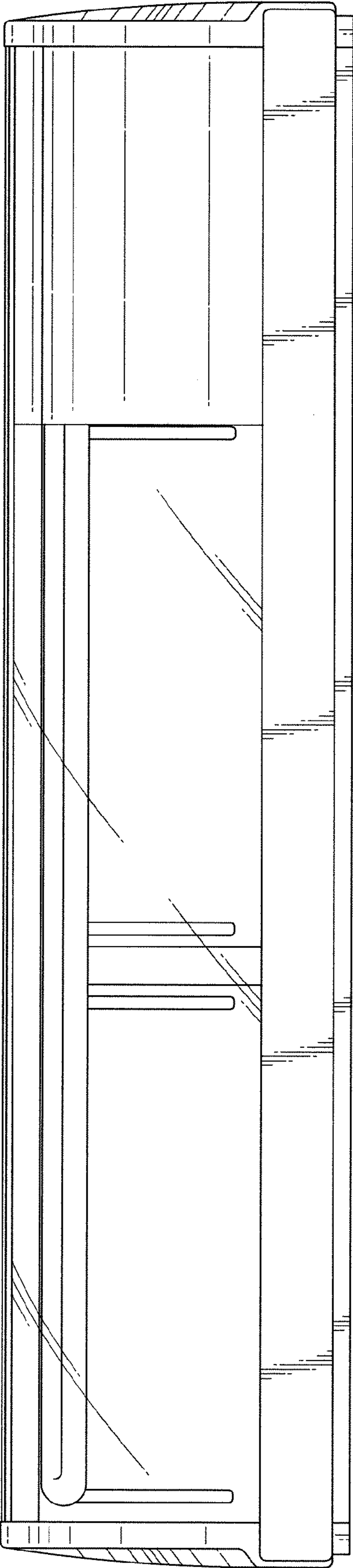

FIG.3

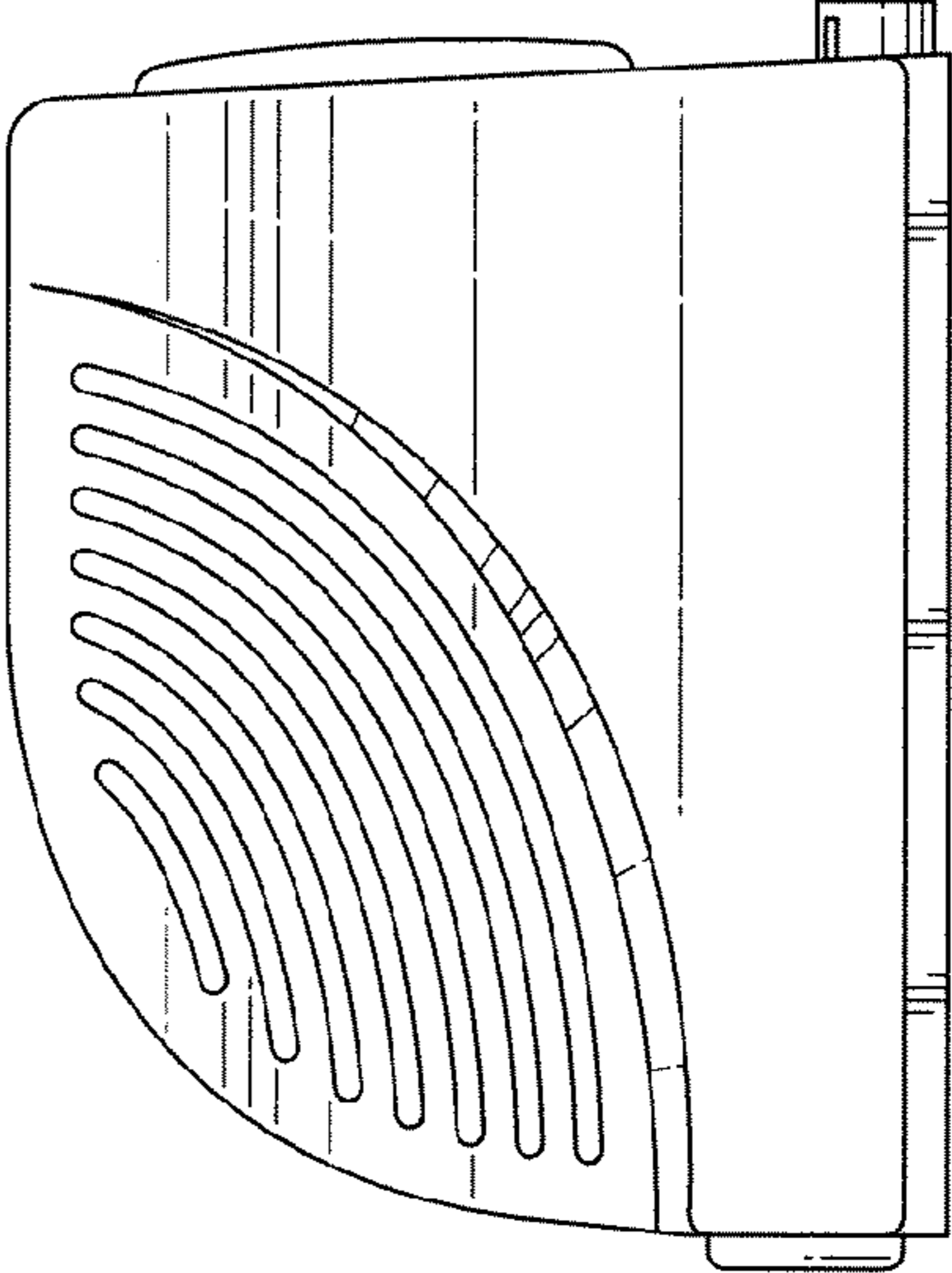

FIG.4

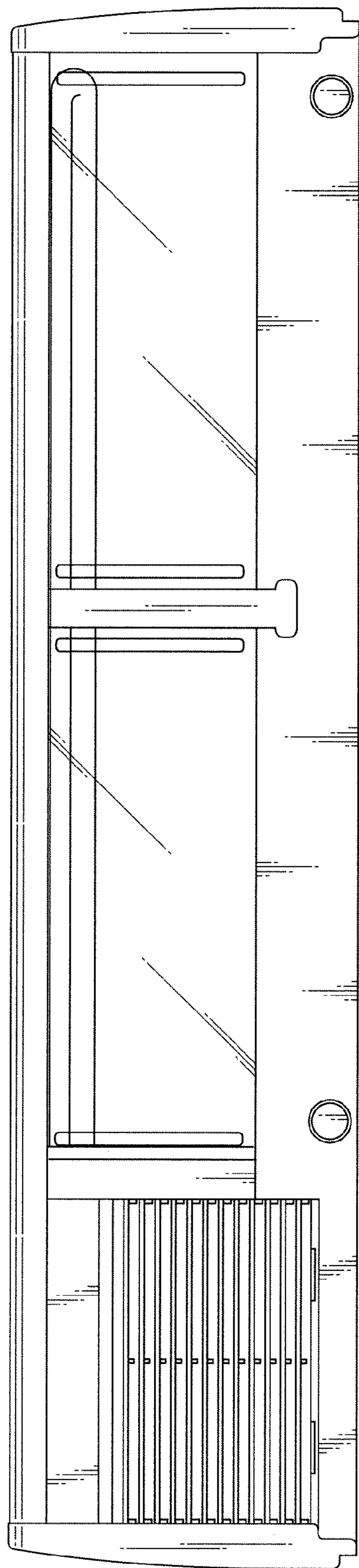

FIG.5

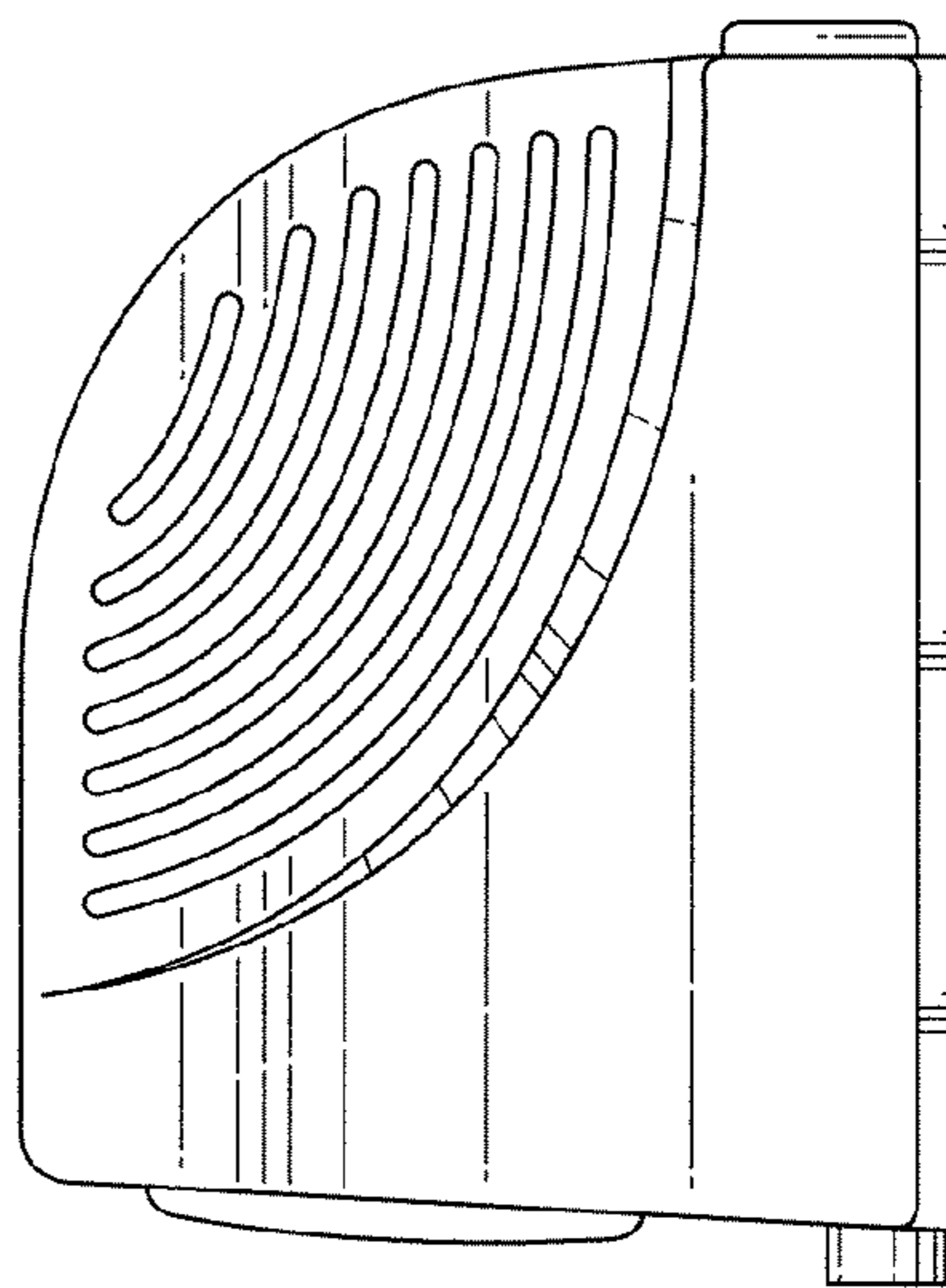

FIG.6

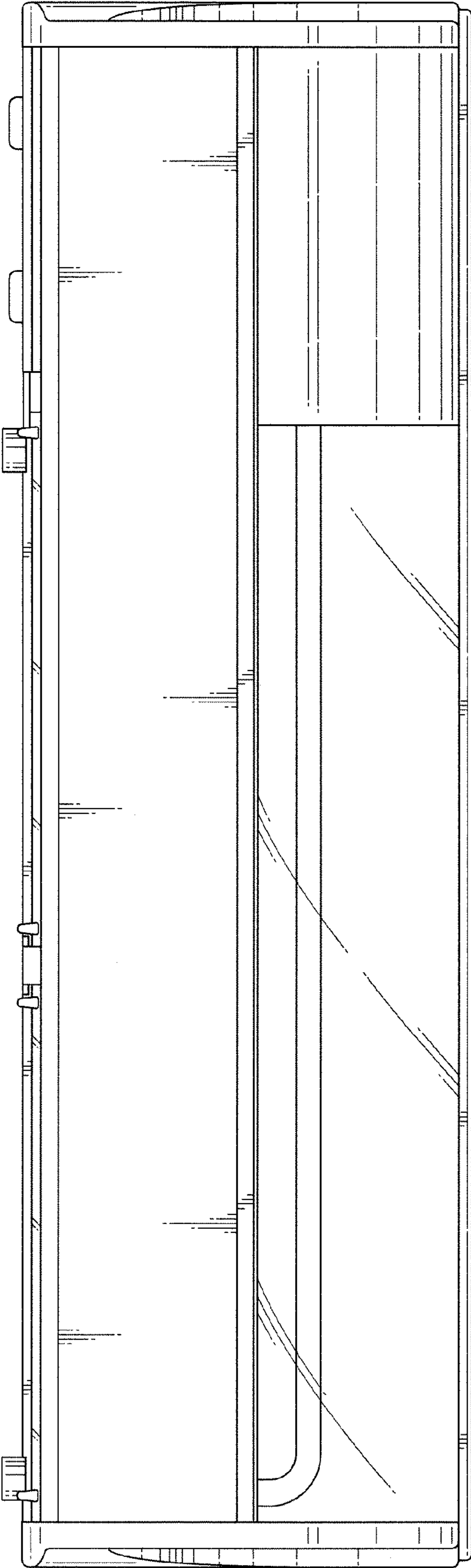

FIG.7

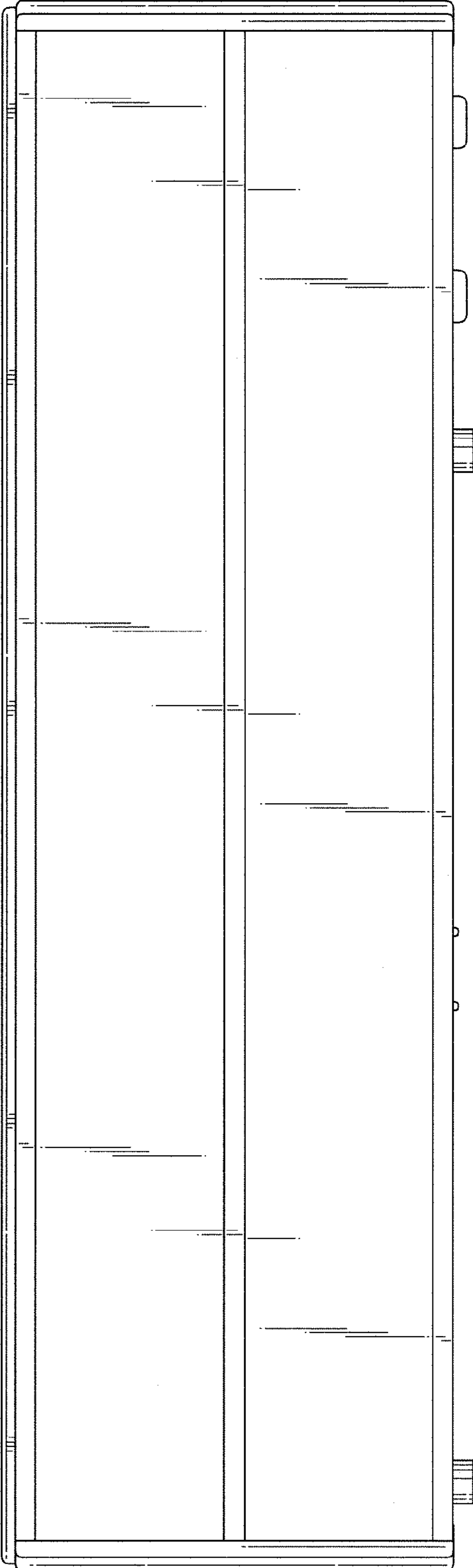

FIG.8

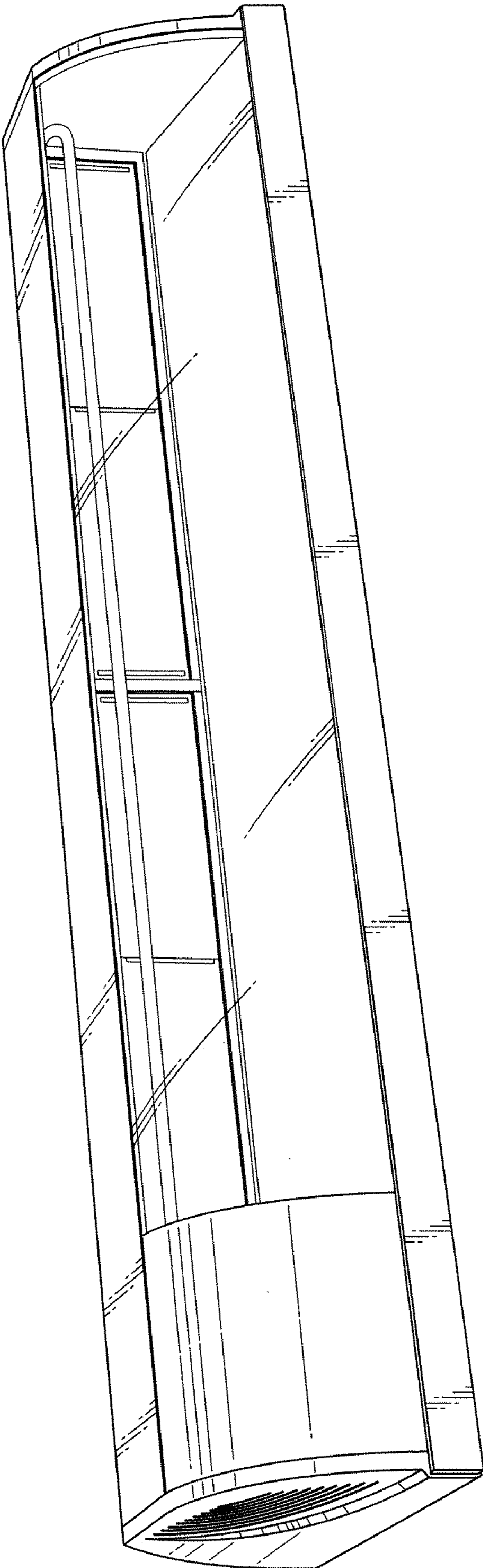



FIG.9

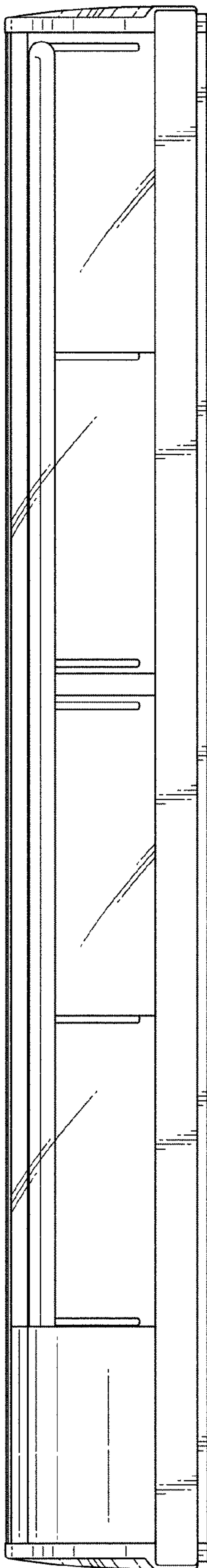

FIG.10

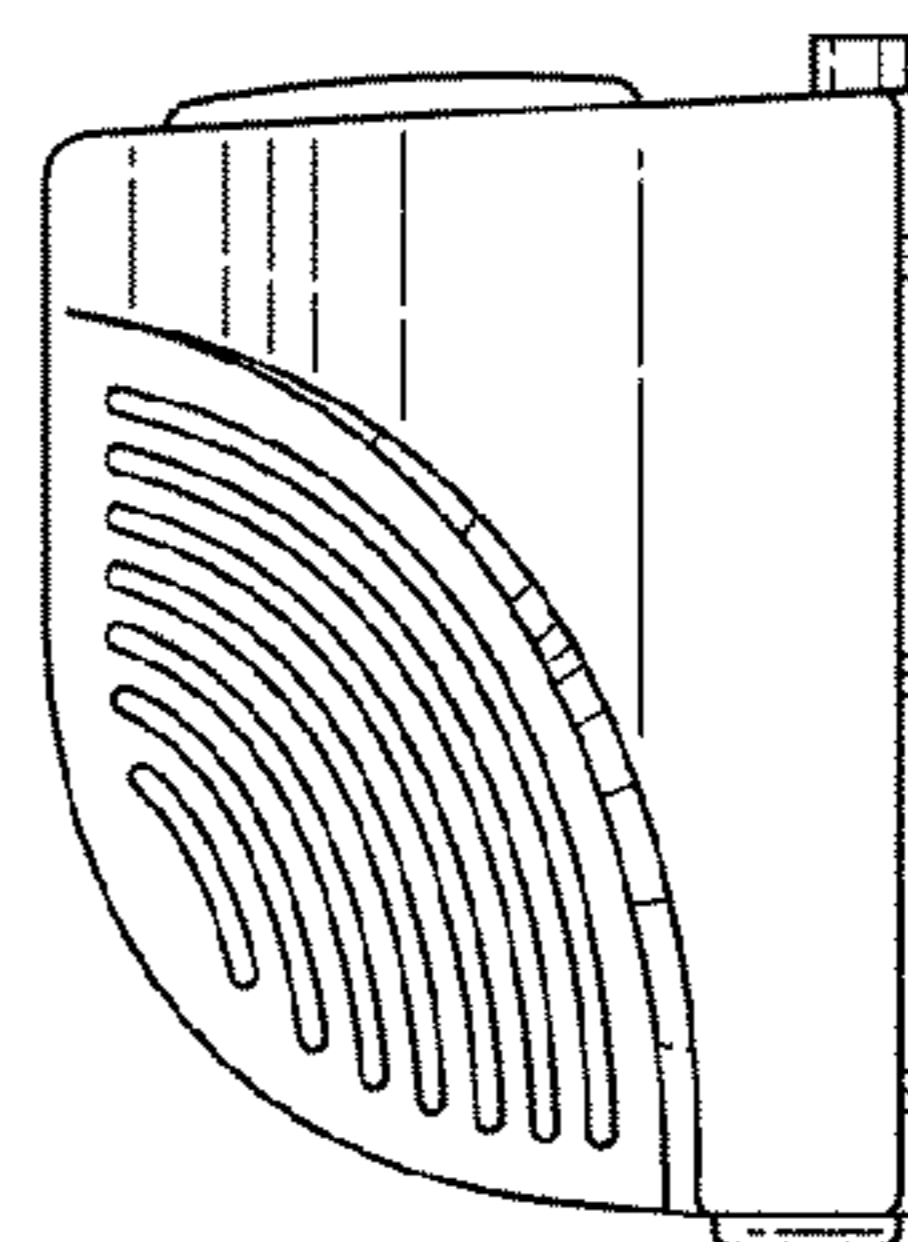

FIG.11

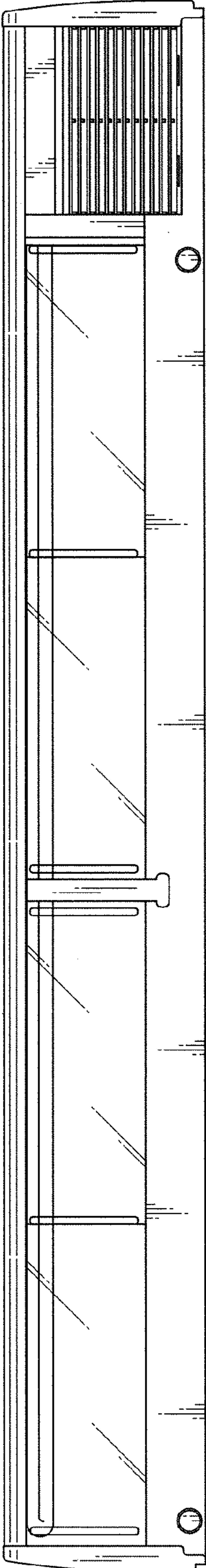

FIG.12

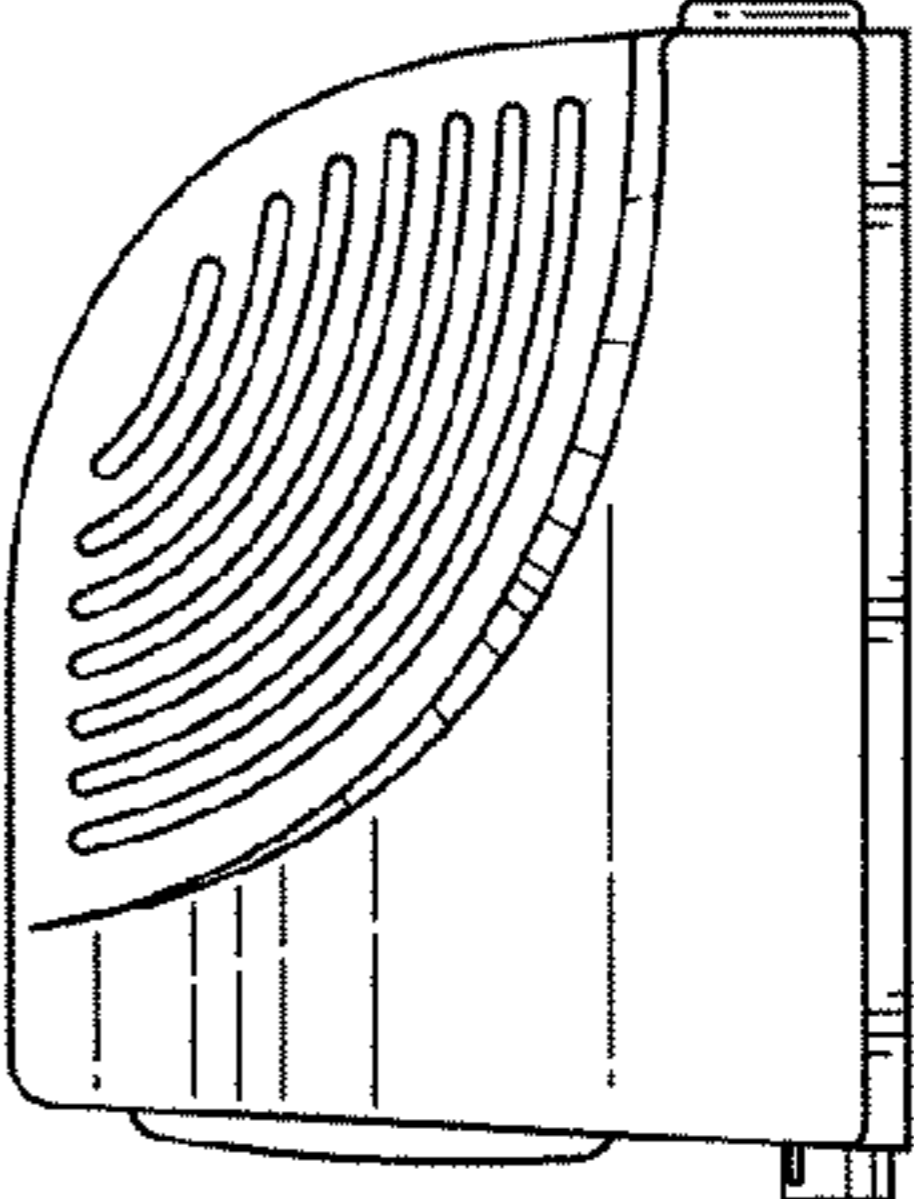

FIG.13

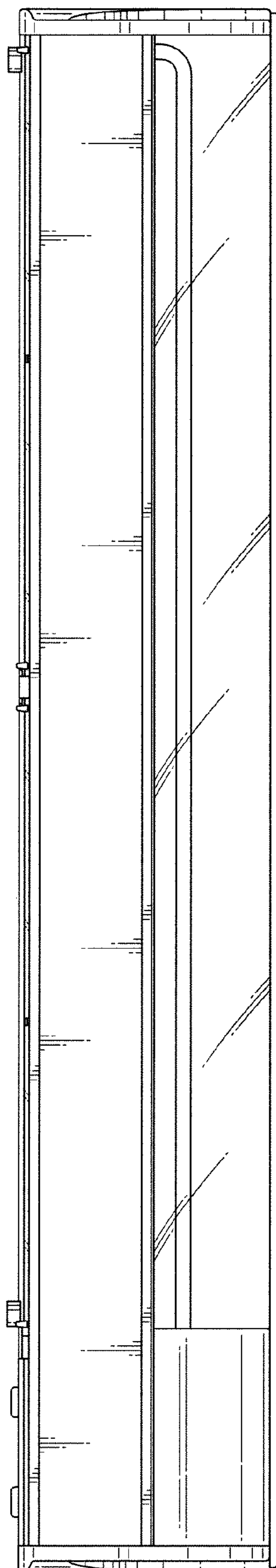

FIG.14

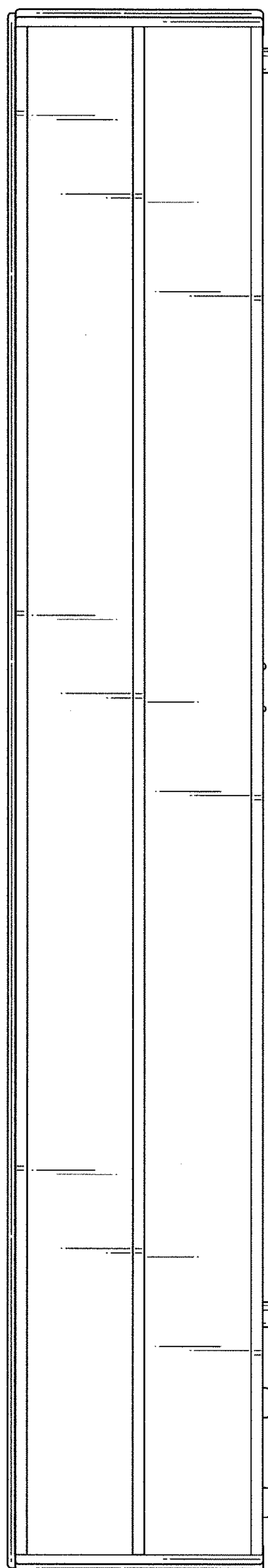

FIG.15

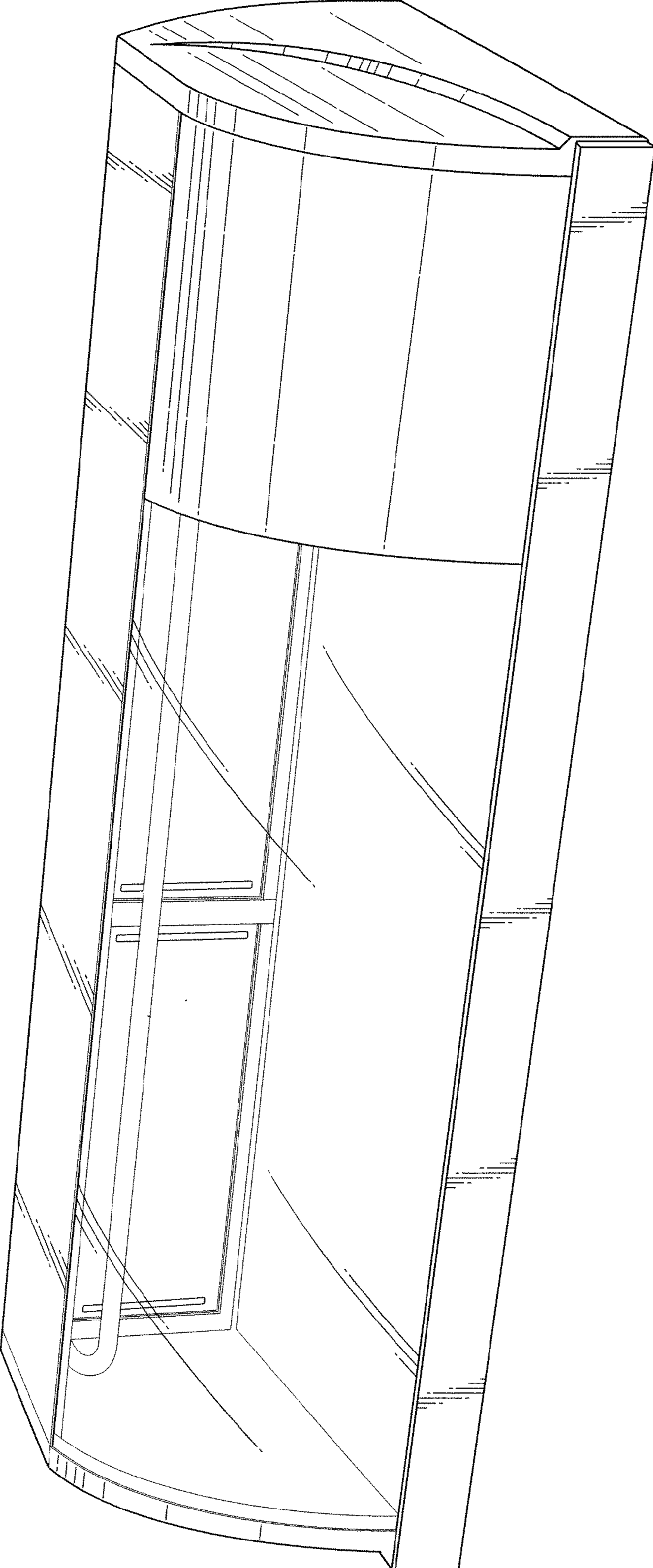

FIG.16

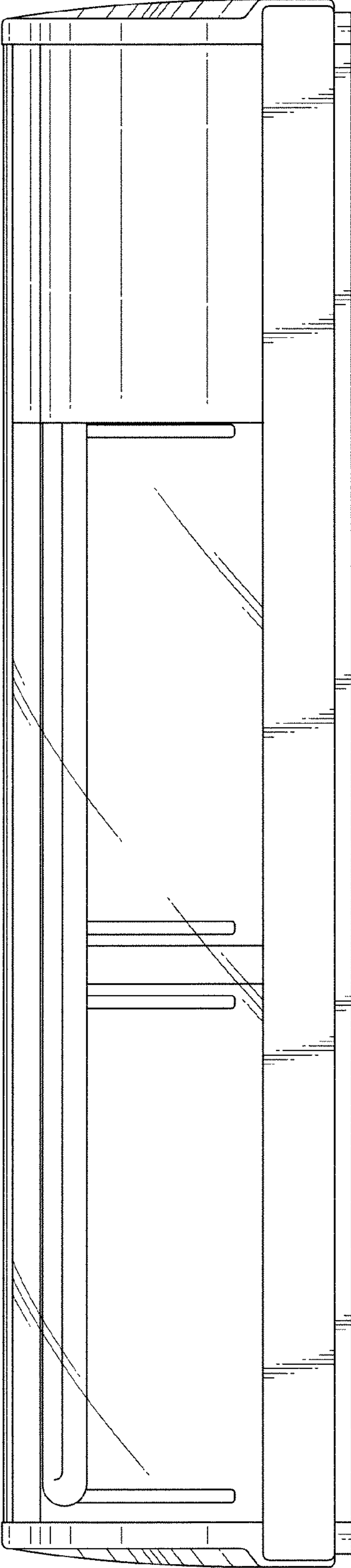

FIG.17

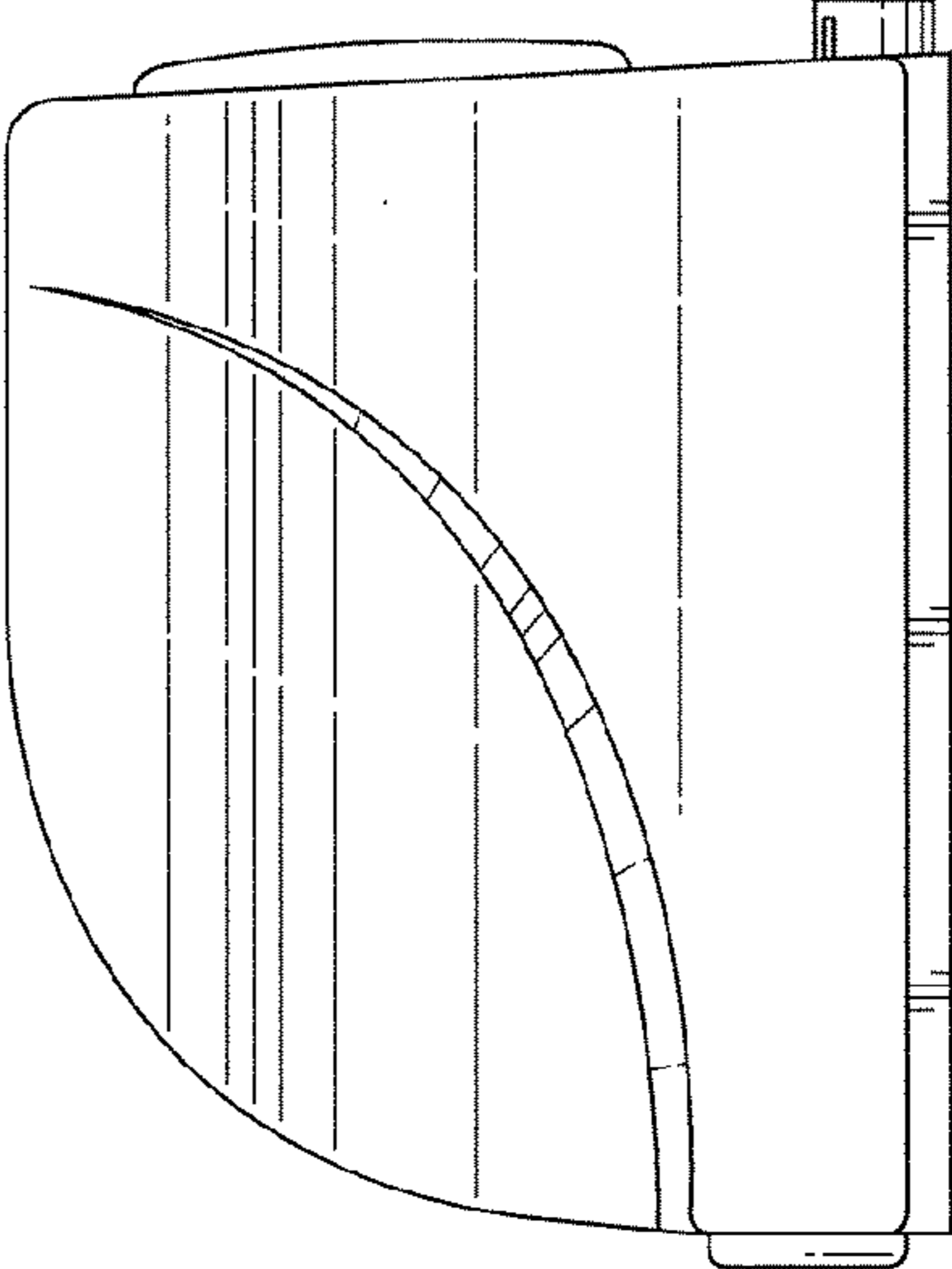

FIG.18

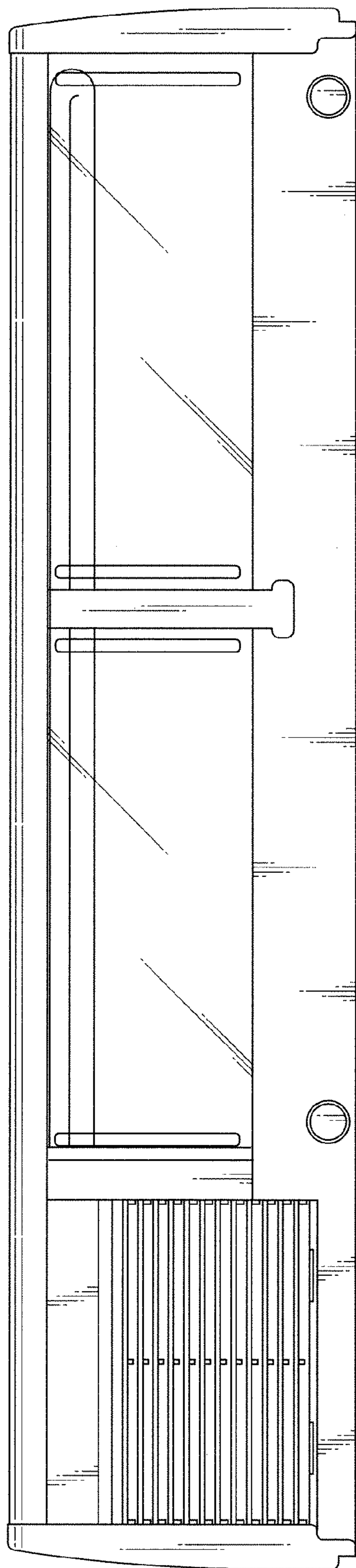

FIG.19

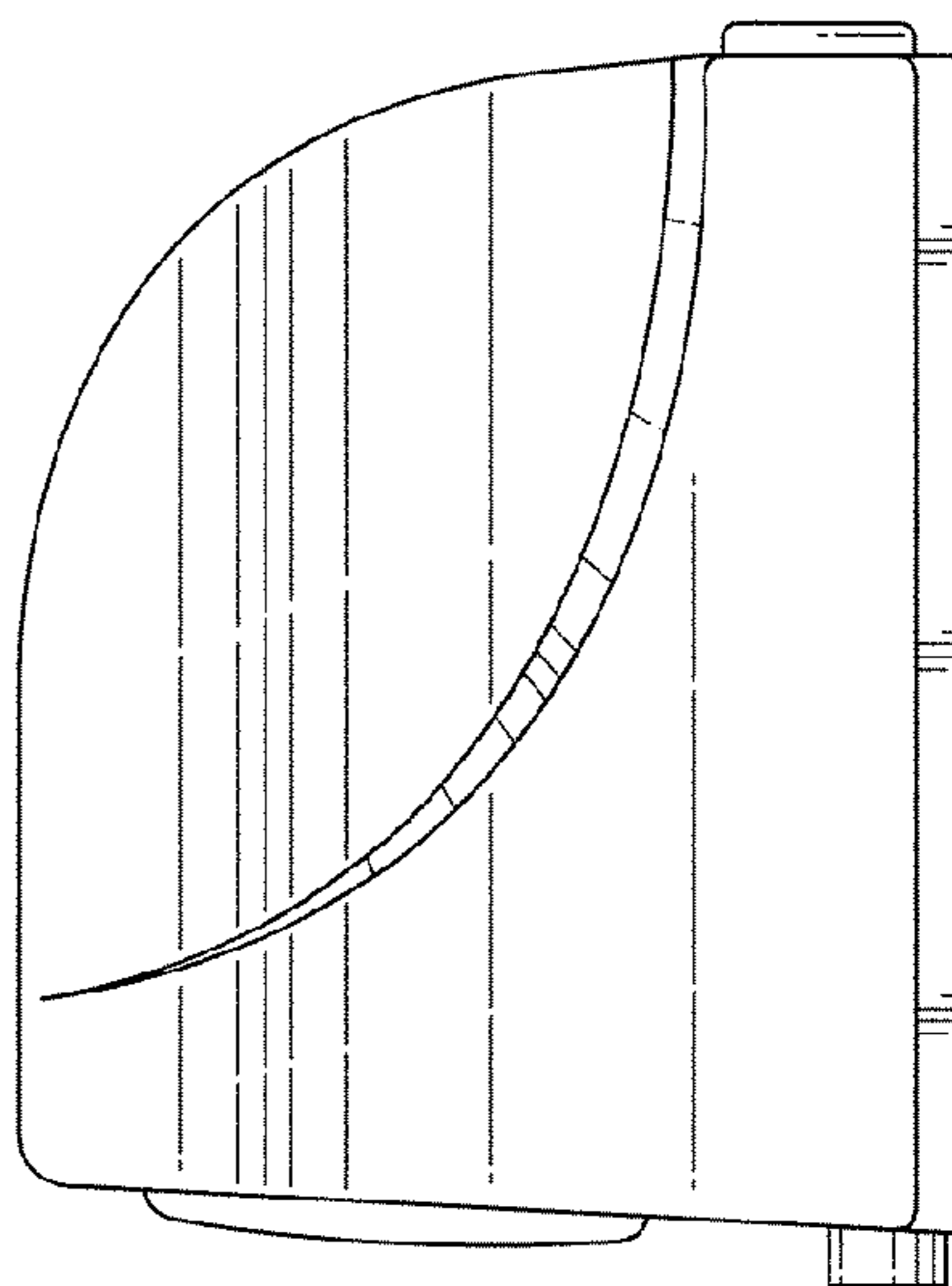

FIG.20

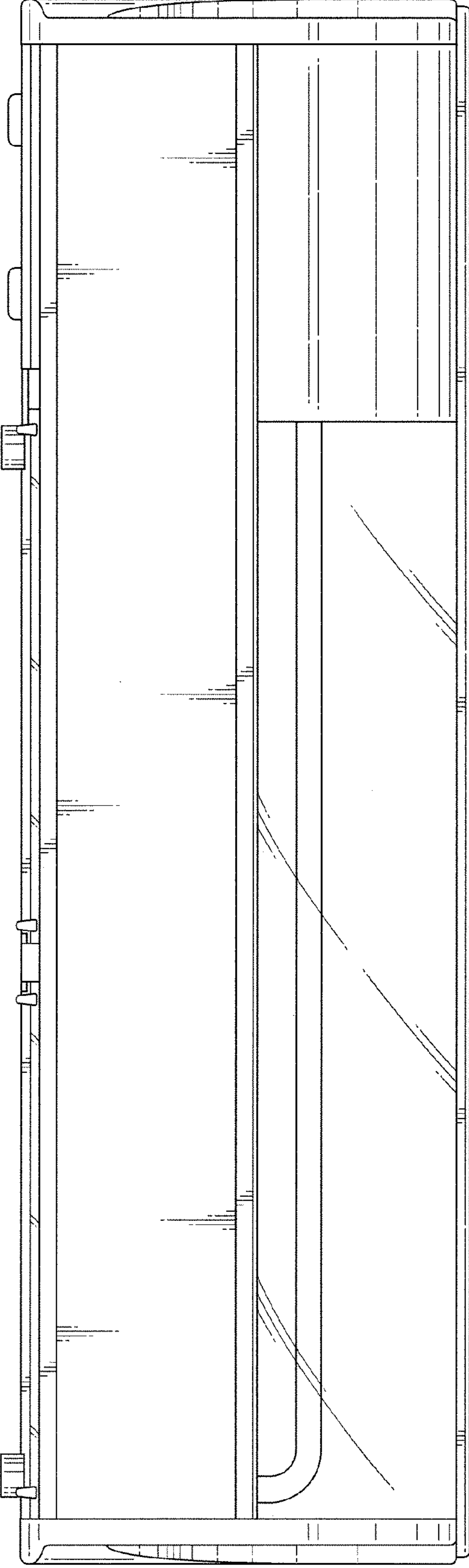

FIG.21

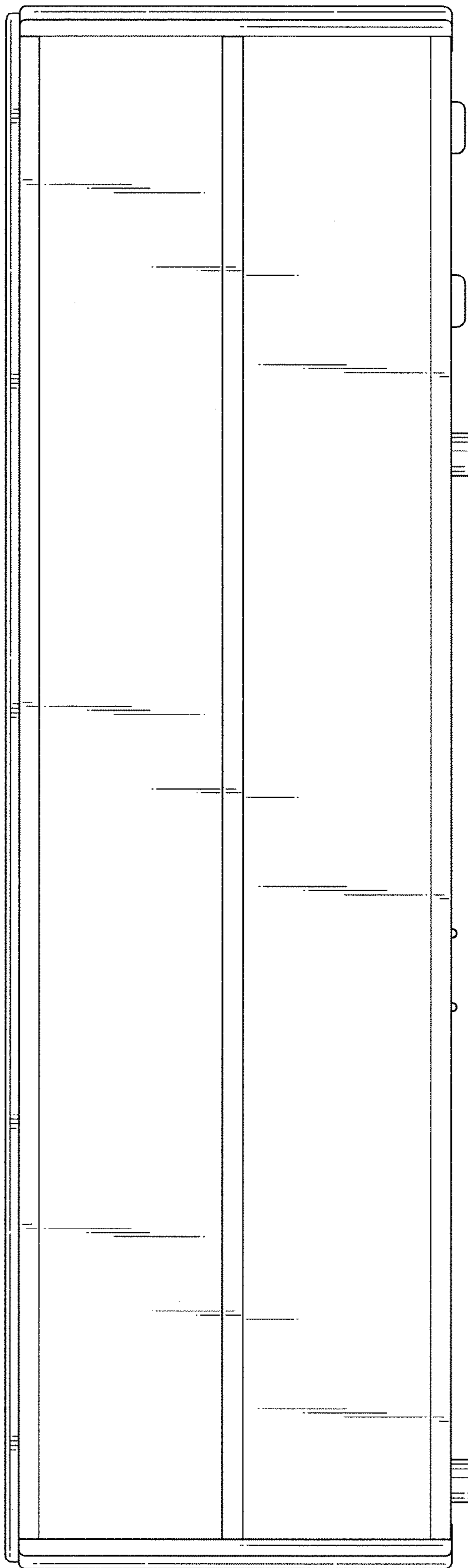



FIG.22

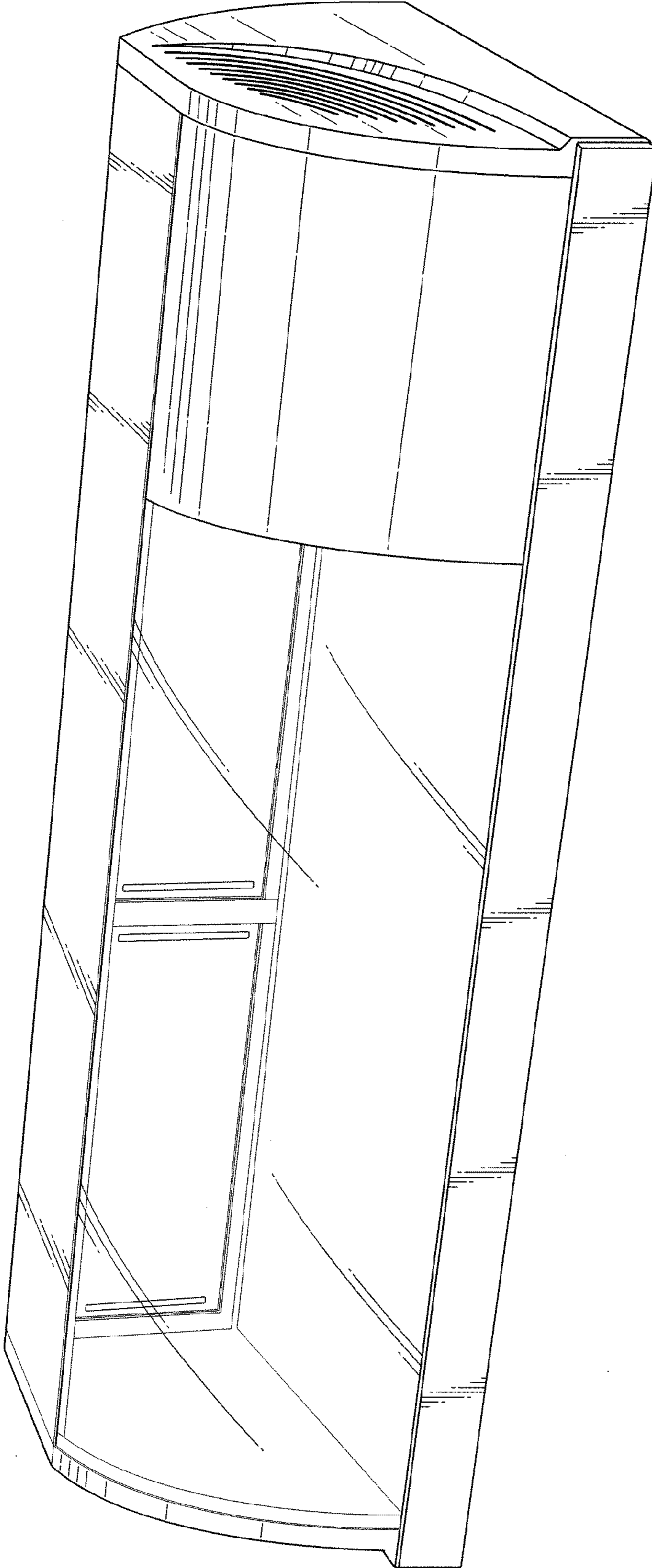

FIG.23

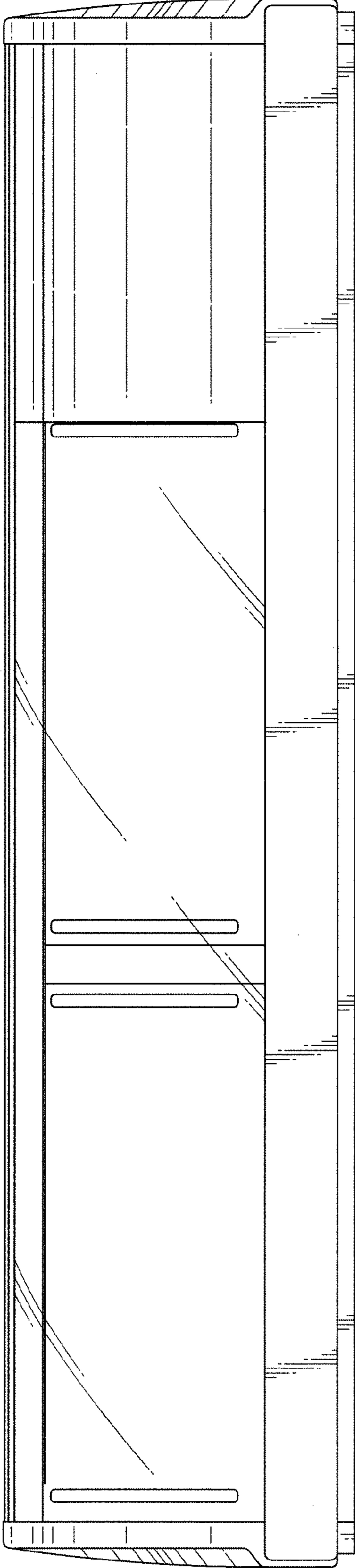

FIG.24

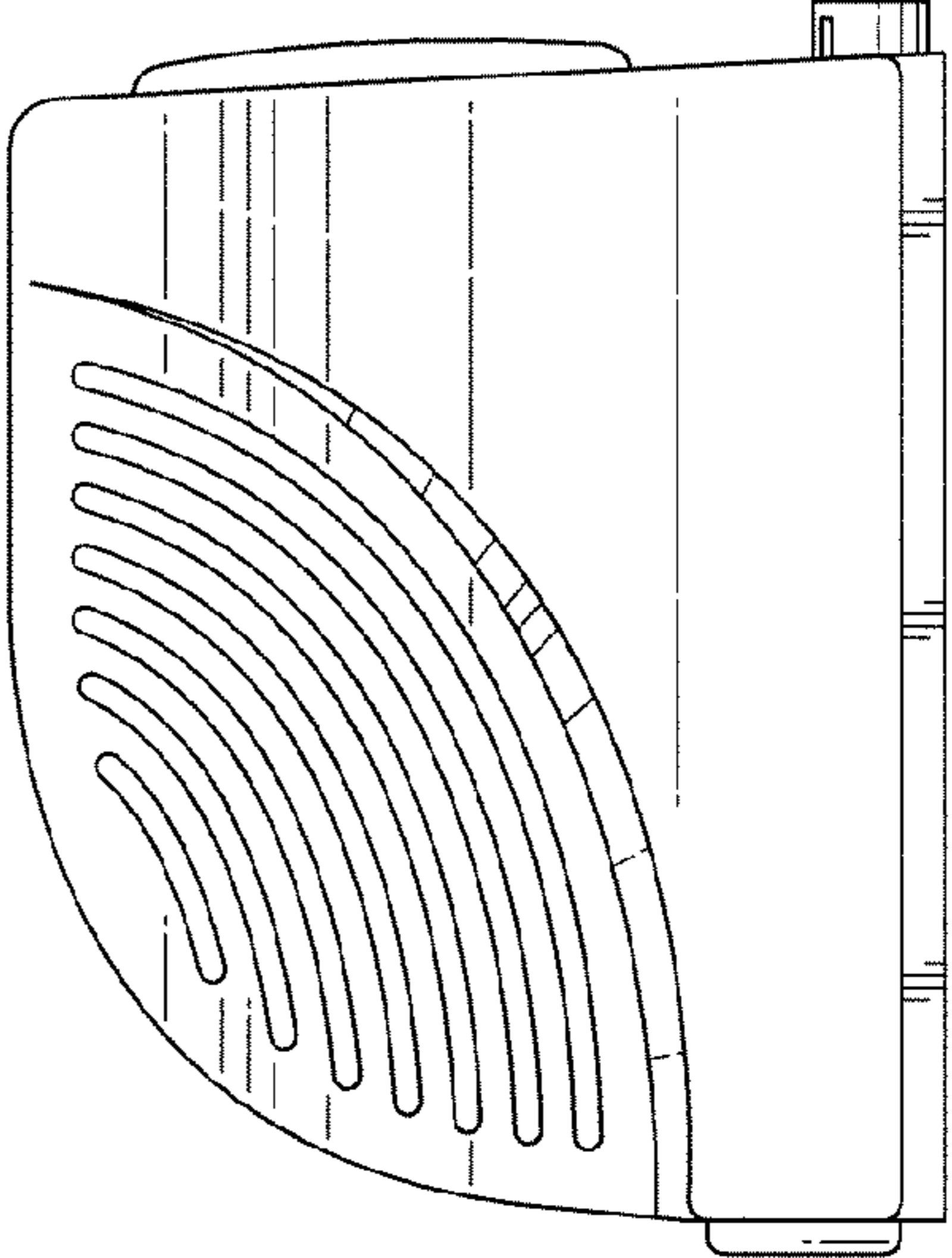

FIG.25

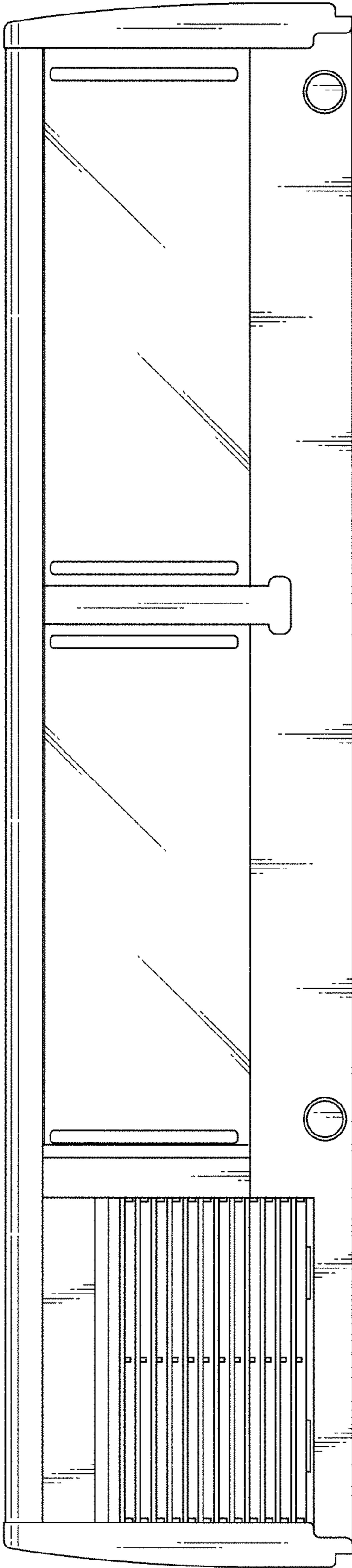

FIG.26

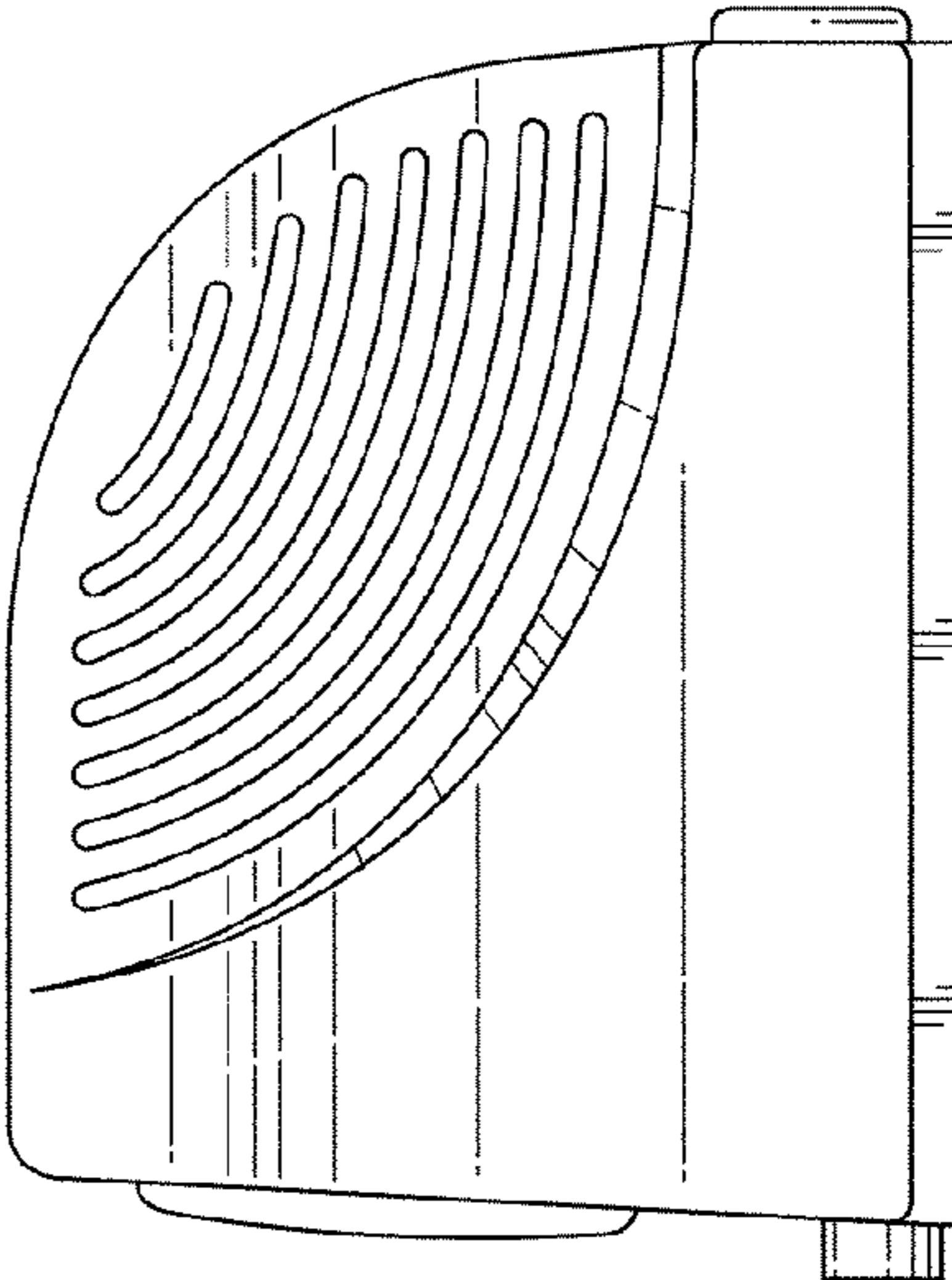

FIG.27

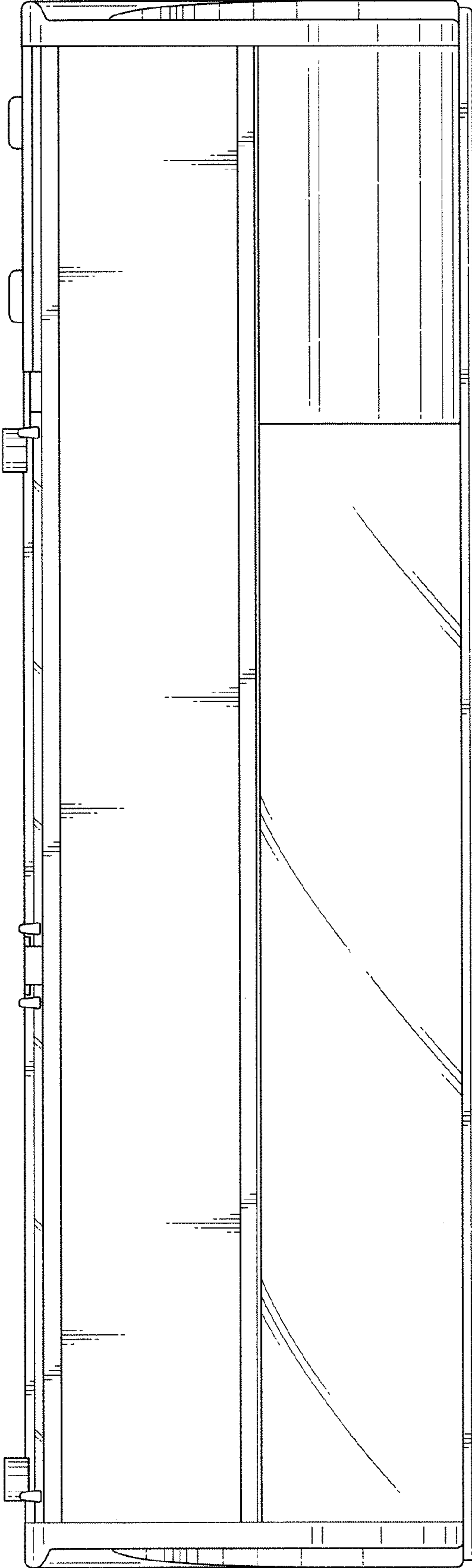

FIG.28

