



US00D624250S

(12) **United States Design Patent**
Hamilton

(10) **Patent No.:** **US D624,250 S**

(45) **Date of Patent:** **** Sep. 21, 2010**

(54) **ANIMAL COLLAR**

2,424,597 A * 7/1947 Werry 441/94

(76) Inventor: **Suzanne Hamilton**, 10260 SW.
Greenburg Rd., Suite 400, Portland, OR
(US) 97223

(Continued)

Primary Examiner—Susan Moon Lee

(74) *Attorney, Agent, or Firm*—Nicole Hyatt

(**) Term: **14 Years**

(21) Appl. No.: **29/358,422**

(57) **CLAIM**

(22) Filed: **Mar. 26, 2010**

I claim the ornamental design for an animal collar, as shown and described.

(51) **LOC (9) Cl.** **30-04**

(52) **U.S. Cl.** **D30/152**

(58) **Field of Classification Search** D30/145,
D30/152, 153, 199; 119/850, 856, 857, 858,
119/863, 865; 5/630–632, 636, 637, 652,
5/655, 655.3–655.9, 656, 926, 646, 647,
5/922, 639, 640, 904, 925, 638, 643, 644,
5/652.1, 653, 654, 657.5, 907, 945, 930;
D21/803, 804, 473, 808, 801, 237; 2/468;
24/61, 64; D24/183, 189; D6/601, 604,
D6/611, 598, 595, 596, 606, 597; 297/397,
297/393, 411.2, 392, 129, 180.11, 188.2,
297/188.12, 195.1, 199, 219.1, 225, 228.1,
297/229, 452.41; 128/845, 864, 118.1, DIG. 23;
602/17, 18; 224/153, 907; 441/123, 129,
441/130, 131, 136, 134, 345; D22/146; D23/311,
D23/236; D12/316; D28/41
See application file for complete search history.

DESCRIPTION

FIG. 1 is a right front perspective view of the animal collar in its open position;

FIG. 2 is a top view of the animal collar in its open position;

FIG. 3 is a front view of the animal collar in its open position; the back view being a mirror image thereof;

FIG. 4 is a bottom view of the animal collar in its open position;

FIG. 5 is a right side view of the animal collar in its open position;

FIG. 6 is a left side view of the animal collar in its open position;

FIG. 7 is a top view of the animal collar in its closed position;

FIG. 8 is a front view of the animal collar in its closed position;

FIG. 9 is a right front perspective view of the animal collar in its closed position;

FIG. 10 is a right side view of the animal collar in its closed position; and,

FIG. 11 is a left front perspective view of the animal collar in its closed position shown in use around a dog's neck.

The broken line showing of a dog is for environmental illustration only and is not part of the claimed design.

(56) **References Cited**

U.S. PATENT DOCUMENTS

- 556,088 A * 3/1896 Daly 441/123
- 763,518 A * 6/1904 Tann 441/131
- 790,682 A * 5/1905 Friedman 441/113
- 1,385,581 A * 7/1921 Pallady 441/123
- 1,487,923 A * 3/1924 De Vilbiss 441/123
- 1,493,664 A * 5/1924 Blum 441/113
- 1,780,986 A * 11/1930 Sipos 441/82
- 1,986,697 A * 1/1935 Wilson 5/630
- 2,210,809 A * 8/1940 Gray 441/123

1 Claim, 5 Drawing Sheets

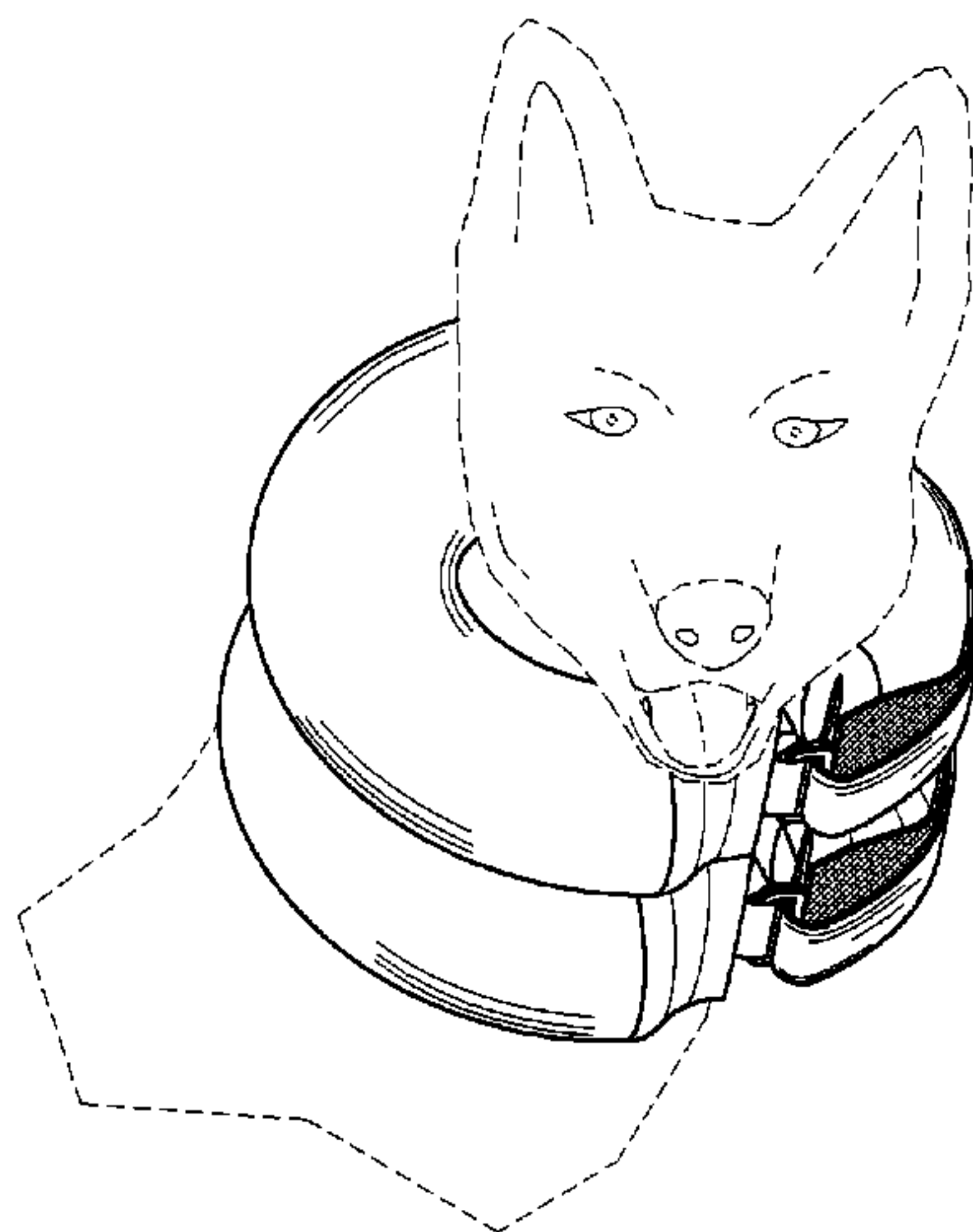

US D624,250 S

Page 2

U.S. PATENT DOCUMENTS

2,536,847	A *	1/1951	Harrow et al.	441/93	5,779,512	A *	7/1998	Rupert	441/123
2,538,775	A *	1/1951	Goldsmith	441/94	5,813,891	A *	9/1998	McNamee	441/108
2,890,467	A *	6/1959	Cowell	441/123	D412,082	S *	7/1999	Goodrich	D6/601
2,937,387	A *	5/1960	Boynton, Jr.	441/93	D413,751	S *	9/1999	Alyea	D6/601
3,048,860	A *	8/1962	Richardson	441/123	6,010,382	A *	1/2000	Kennedy	441/66
RE25,398	E *	6/1963	Moran	441/111	6,038,720	A *	3/2000	Matthews et al.	5/639
3,144,667	A *	8/1964	Dobbs	441/93	6,041,715	A *	3/2000	Jarke et al.	108/43
3,308,494	A *	3/1967	Licher	441/97	D434,506	S *	11/2000	Jordan	D24/206
3,633,230	A *	1/1972	Horton	441/93	6,234,857	B1 *	5/2001	Suellentrop	441/129
3,925,838	A *	12/1975	Kennedy	441/96	6,457,195	B1 *	10/2002	Holste	5/636
4,161,794	A *	7/1979	Darnfors	5/644	6,463,608	B1 *	10/2002	Moe	5/646
D255,966	S *	7/1980	Stadel	D6/604	6,523,200	B2 *	2/2003	Brown	5/639
D263,616	S *	3/1982	Canty	D21/803	6,625,828	B2 *	9/2003	Matthews Brown	5/636
4,360,351	A *	11/1982	Travinski	441/94	6,641,221	B1 *	11/2003	Kastlunger	297/397
4,476,814	A *	10/1984	Miller	119/821	6,659,825	B2 *	12/2003	Foss	441/123
4,540,372	A *	9/1985	Mauck	441/81	D489,211	S *	5/2004	Grannum	D6/601
4,622,018	A *	11/1986	Blanc	441/123	D522,300	S *	6/2006	Roberts	D6/601
4,687,452	A *	8/1987	Hull	441/131	D532,075	S *	11/2006	Turner	D22/199
4,799,910	A *	1/1989	Kellough	441/131	7,160,167	B2 *	1/2007	Peters	441/88
5,010,850	A *	4/1991	Sailer	297/129	7,186,158	B1 *	3/2007	Barber et al.	441/123
5,022,879	A *	6/1991	DiForte	441/113	D550,495	S *	9/2007	Boutin	D6/601
5,046,978	A *	9/1991	Howerton	441/131	7,306,501	B2 *	12/2007	Pierce et al.	441/83
D322,380	S *	12/1991	El-Asir	D6/604	7,404,222	B2 *	7/2008	Tidwell	5/655
5,133,084	A *	7/1992	Martin	2/468	7,451,508	B2 *	11/2008	Matthews Brown et al.	5/655
5,257,429	A *	11/1993	Genis	5/636	D583,605	S *	12/2008	Krinsky et al.	D6/601
5,261,134	A *	11/1993	Matthews	5/655	2002/0004948	A1 *	1/2002	Son	2/468
D348,174	S *	6/1994	Genis	D6/601	2003/0037735	A1 *	2/2003	Albers et al.	119/863
5,382,184	A *	1/1995	DiForte, Jr.	441/108	2003/0150401	A1 *	8/2003	Schmid et al.	119/815
5,421,760	A *	6/1995	Blaga	441/123	2004/0154104	A1 *	8/2004	Brown et al.	5/644
5,519,906	A *	5/1996	Fanto-Chan	5/631	2006/0185617	A1 *	8/2006	Kenny	119/707
5,584,736	A *	12/1996	Salvemini	441/85	2006/0217014	A1 *	9/2006	Pierce et al.	441/123
5,661,861	A *	9/1997	Matthews	5/633	2007/0271703	A1 *	11/2007	Matthews Brown et al.	5/636
					2008/0034504	A1 *	2/2008	Schmidt	5/644

* cited by examiner

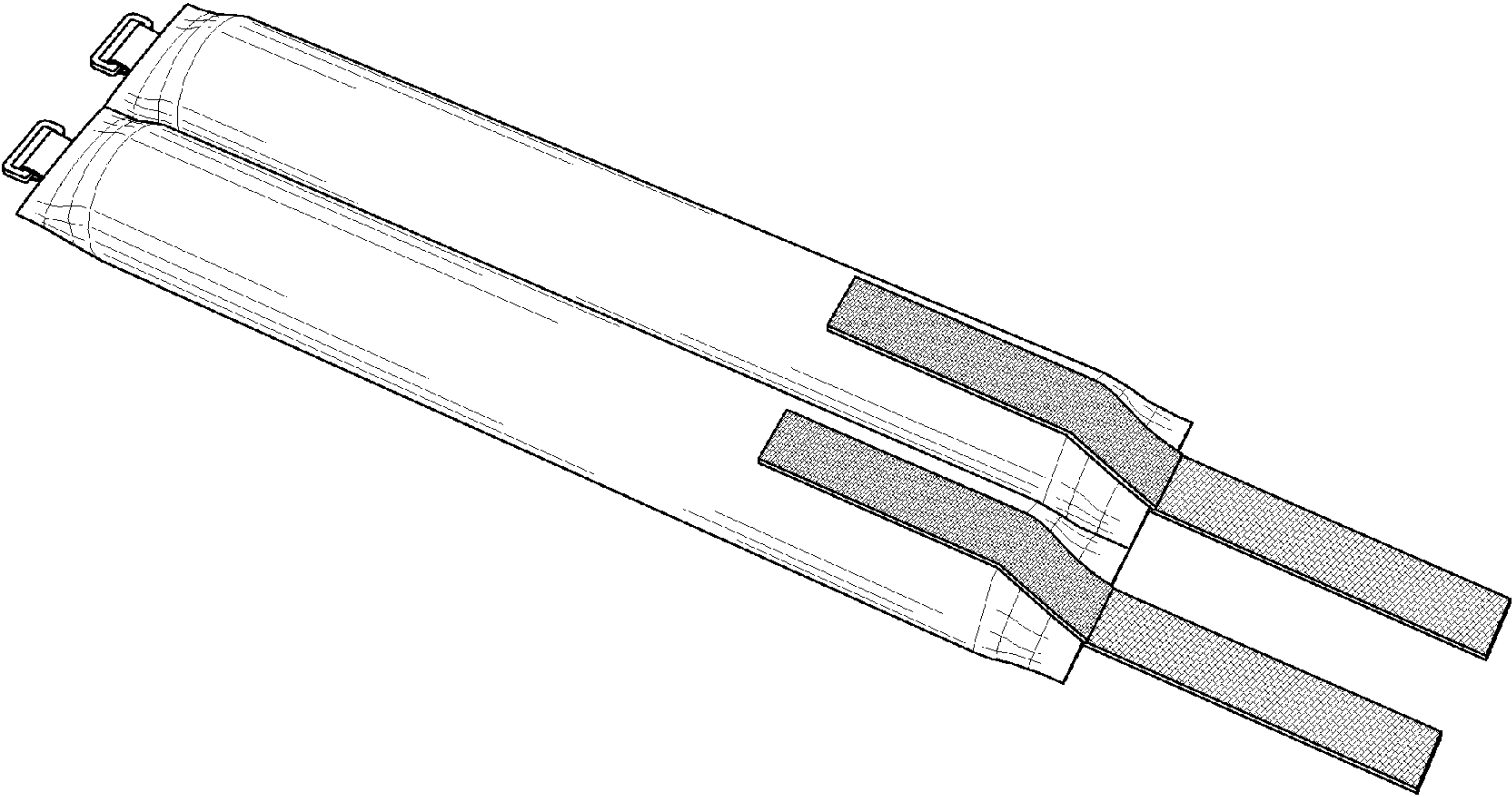

FIG. 1

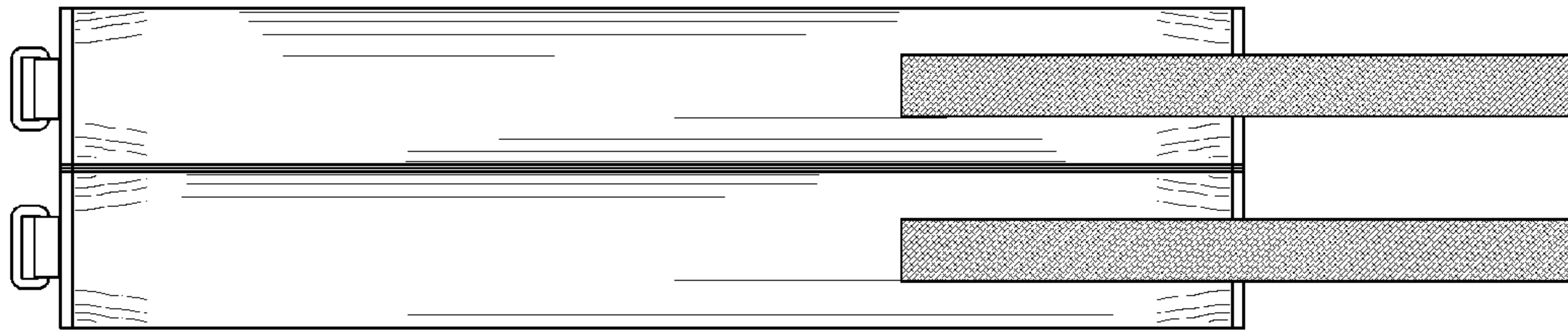

FIG. 2

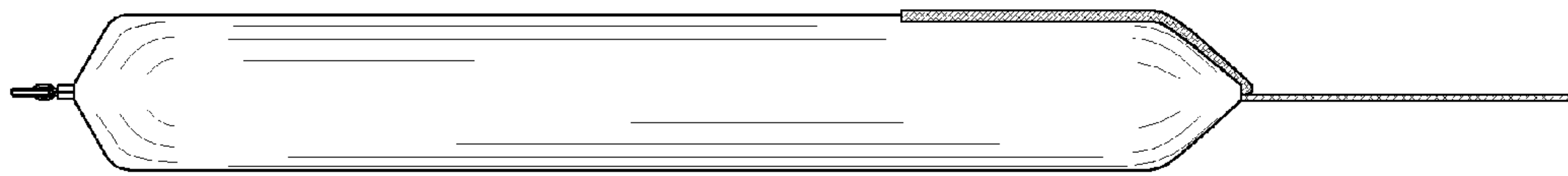

FIG. 3

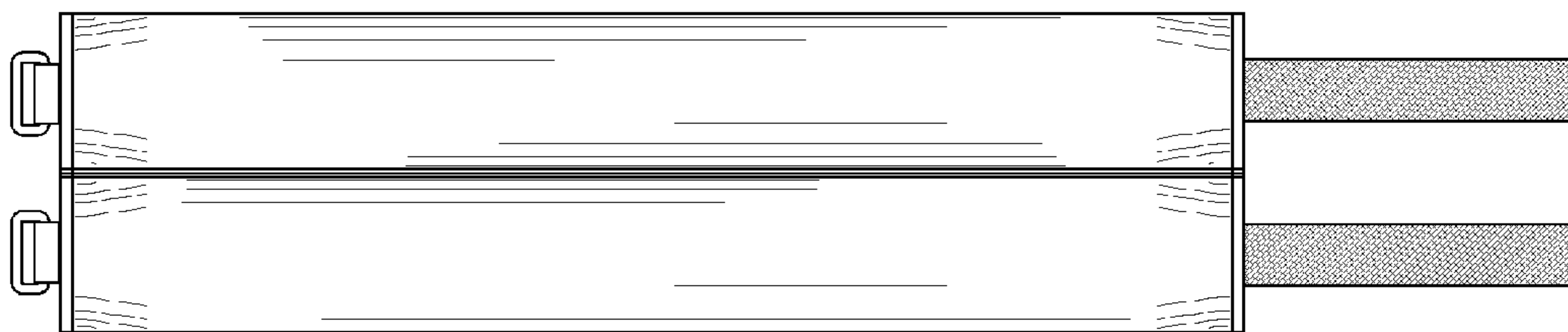

FIG. 4

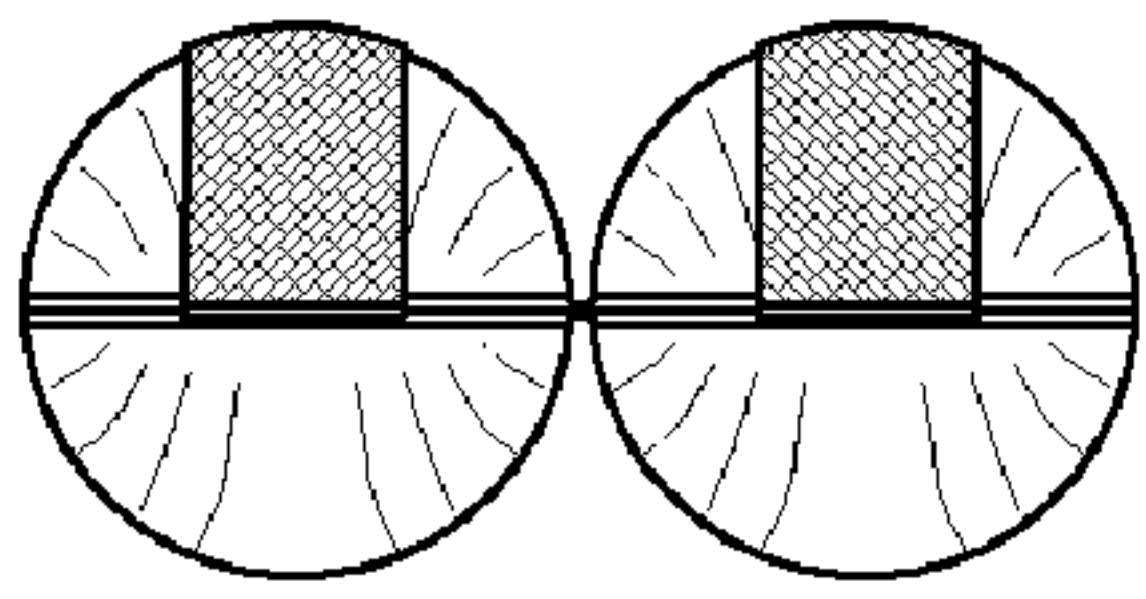

FIG. 5

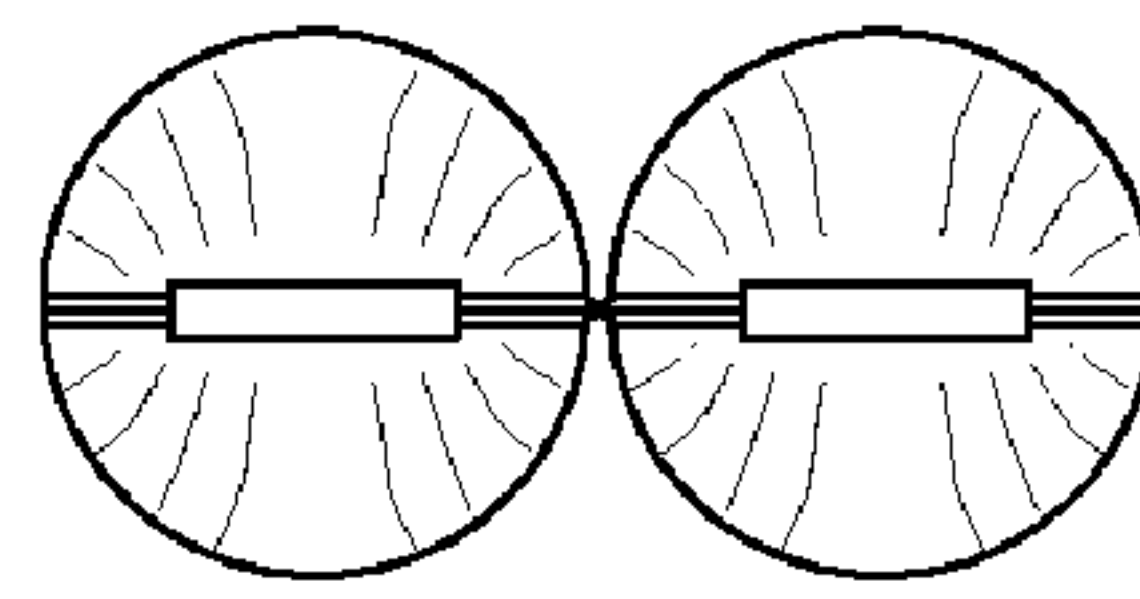

FIG. 6



FIG. 7

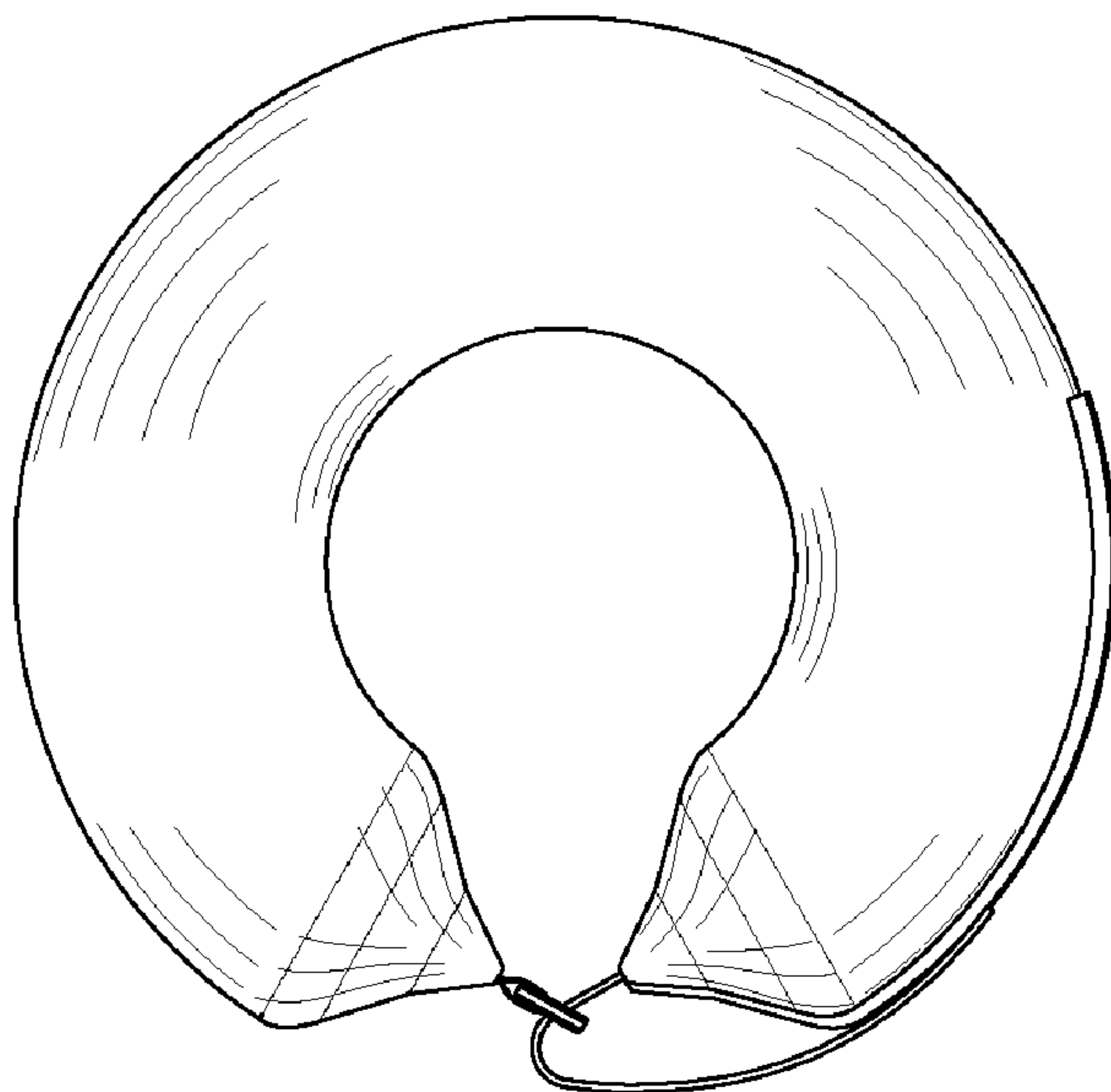

FIG. 8

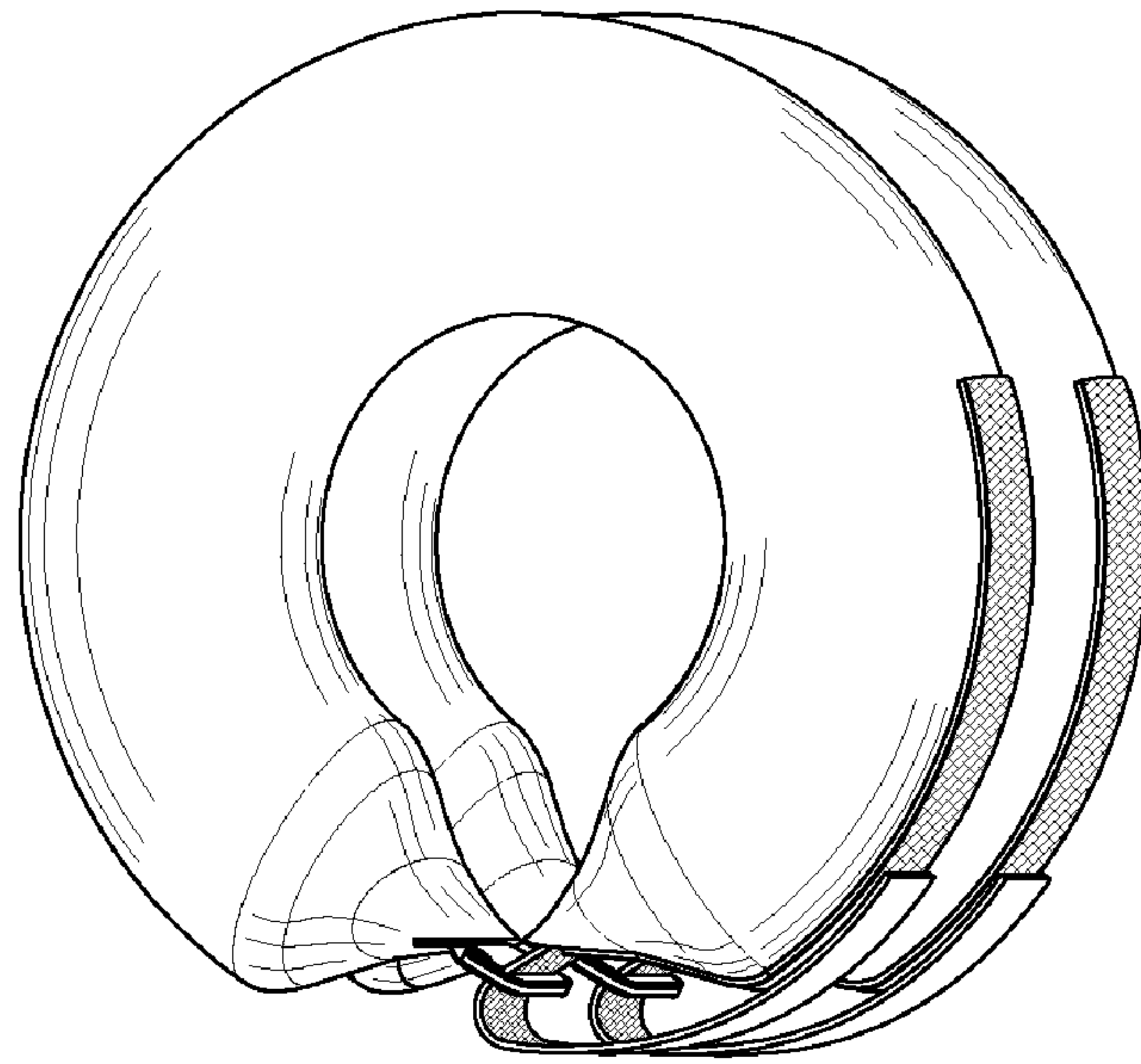

FIG. 9

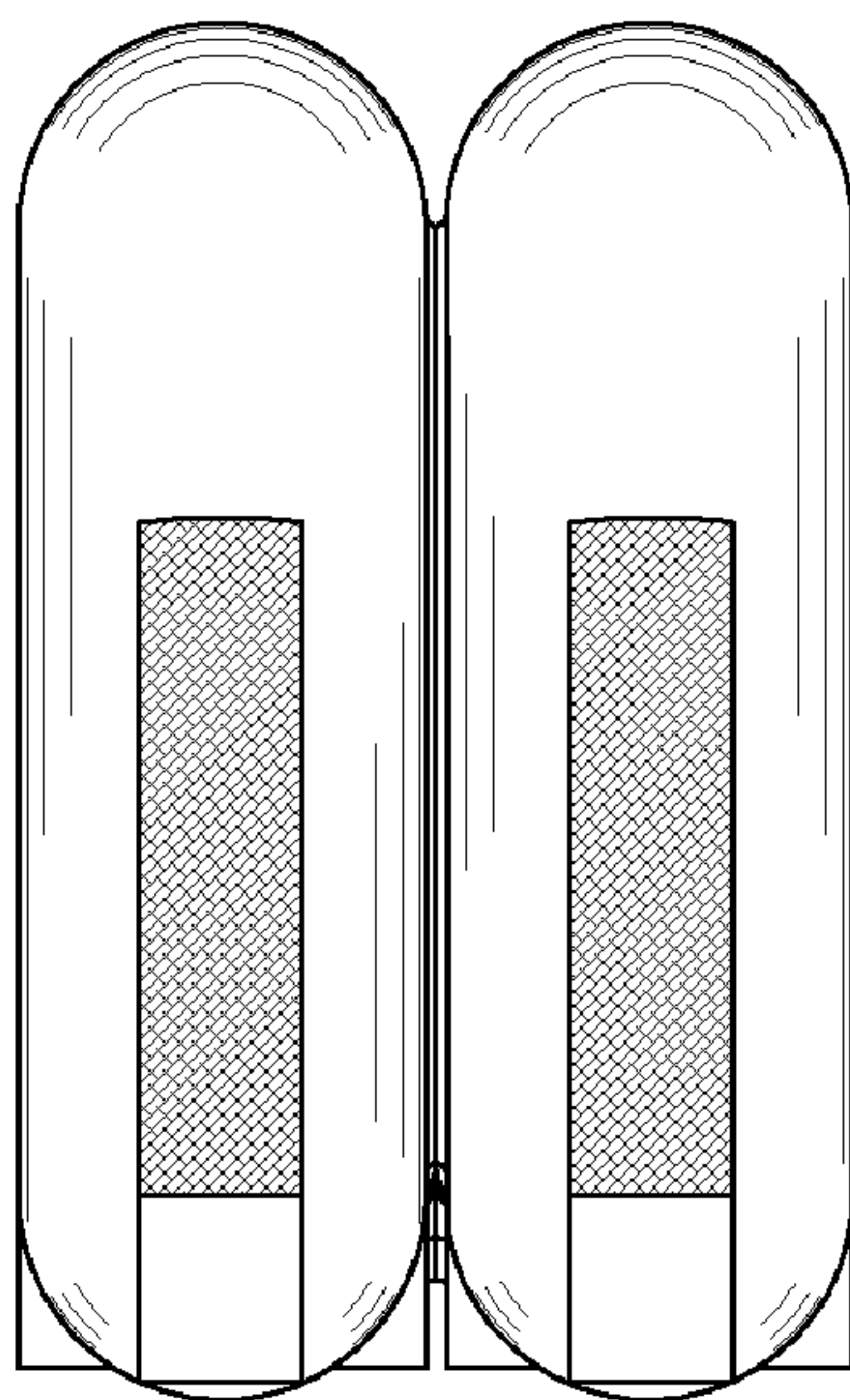

FIG. 10

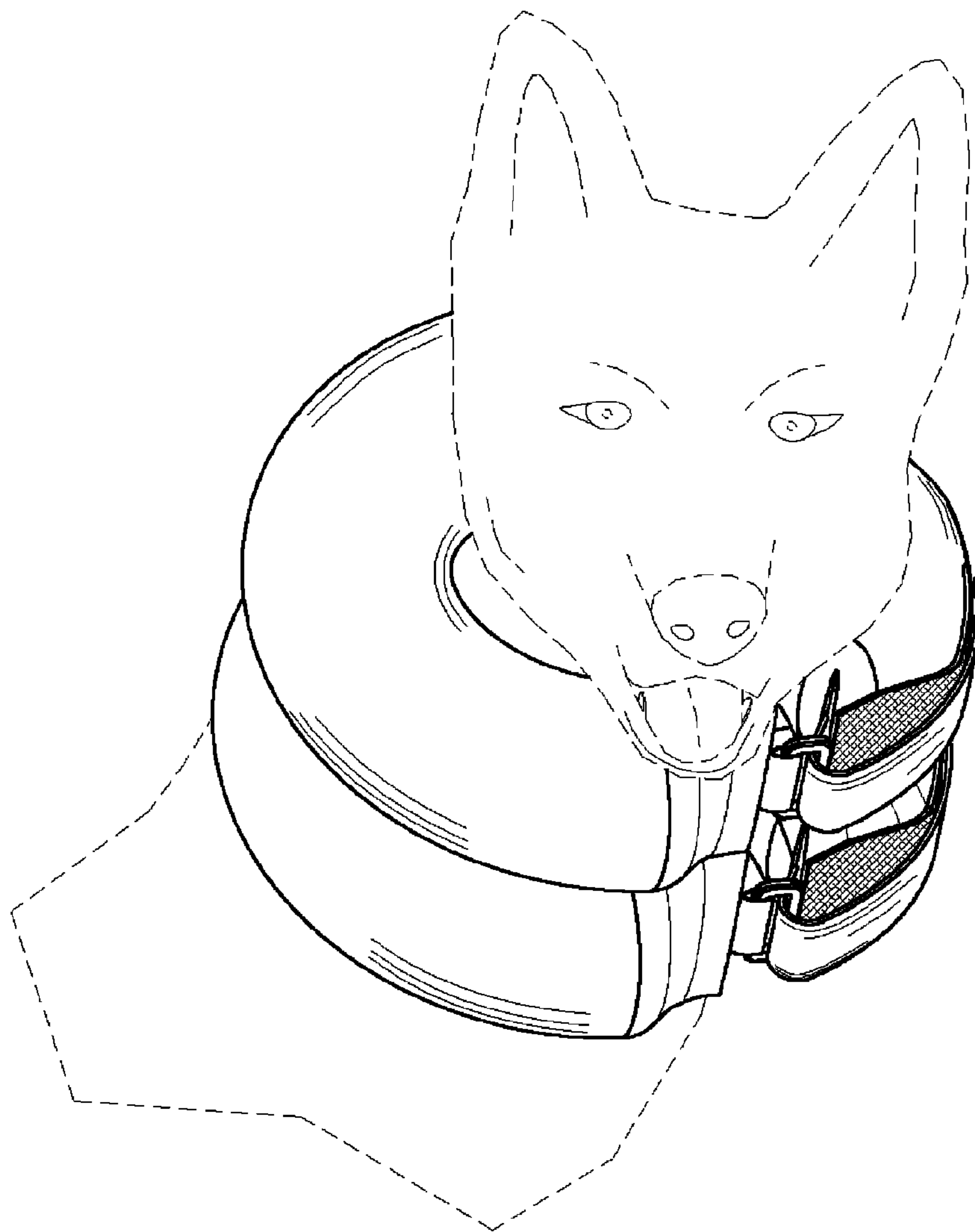

FIG. 11