



US00D624104S

(12) **United States Design Patent**  
**Miyake et al.**

(10) **Patent No.:** **US D624,104 S**  
(45) **Date of Patent:** **\*\* Sep. 21, 2010**

(54) **INDUSTRIAL ROBOT**

(75) Inventors: **Takanori Miyake**, Chiyoda-ku (JP);  
**Haruo Ito**, Chiyoda-ku (JP)

(73) Assignee: **Mitsubishi Electric Corporation**,  
Tokyo (JP)

(\*\*) Term: **14 Years**

(21) Appl. No.: **29/358,145**

(22) Filed: **Mar. 23, 2010**

(30) **Foreign Application Priority Data**

Sep. 24, 2009 (JP) ..... 2009-021900

(51) **LOC (9) Cl.** ..... **15-99**

(52) **U.S. Cl.** ..... **D15/199; 15/99**

(58) **Field of Classification Search** ..... D15/199;  
74/490.01, 490.02, 490.03, 490.05; 219/124.34,  
219/639; 318/560; 700/99, 150

See application file for complete search history.

(56) **References Cited**

**U.S. PATENT DOCUMENTS**

4,076,131 A \* 2/1978 Dahlstrom et al. .... 414/730  
D269,681 S \* 7/1983 Morser et al. .... D15/199  
D279,571 S \* 7/1985 Arai et al. .... D15/199  
D279,572 S \* 7/1985 Yasuoka et al. .... D15/199  
D280,203 S \* 8/1985 Shibayama et al. .... D15/199

4,586,868 A \* 5/1986 Nakashima et al. .... 414/735  
D293,324 S \* 12/1987 Gotou et al. .... D15/199  
D296,790 S \* 7/1988 Tsuburaya et al. .... D15/199  
D300,935 S \* 5/1989 Maddock et al. .... D15/199  
D334,581 S \* 4/1993 Yoshikawa et al. .... D15/199  
D440,241 S \* 4/2001 Kawahara et al. .... D15/199  
D443,287 S \* 6/2001 Kawahara et al. .... D15/199  
D615,574 S \* 5/2010 Liu et al. .... D15/199  
2005/0092122 A1 \* 5/2005 Markert et al. .... 74/490.01

\* cited by examiner

*Primary Examiner*—Sandra Snapp

*Assistant Examiner*—Patricia Palasik

(74) *Attorney, Agent, or Firm*—Sughrue Mion, PLLC

(57) **CLAIM**

The ornamental design for an industrial robot, as shown and described.

**DESCRIPTION**

FIG. 1 is a front, top and right side perspective view of an industrial robot, showing our new design;

FIG. 2 is a front elevational view thereof;

FIG. 3 is a rear elevational view thereof;

FIG. 4 is a left side elevational view thereof;

FIG. 5 is a right side elevational view thereof;

FIG. 6 is a top plan view thereof; and,

FIG. 7 is a bottom plan view thereof.

**1 Claim, 5 Drawing Sheets**

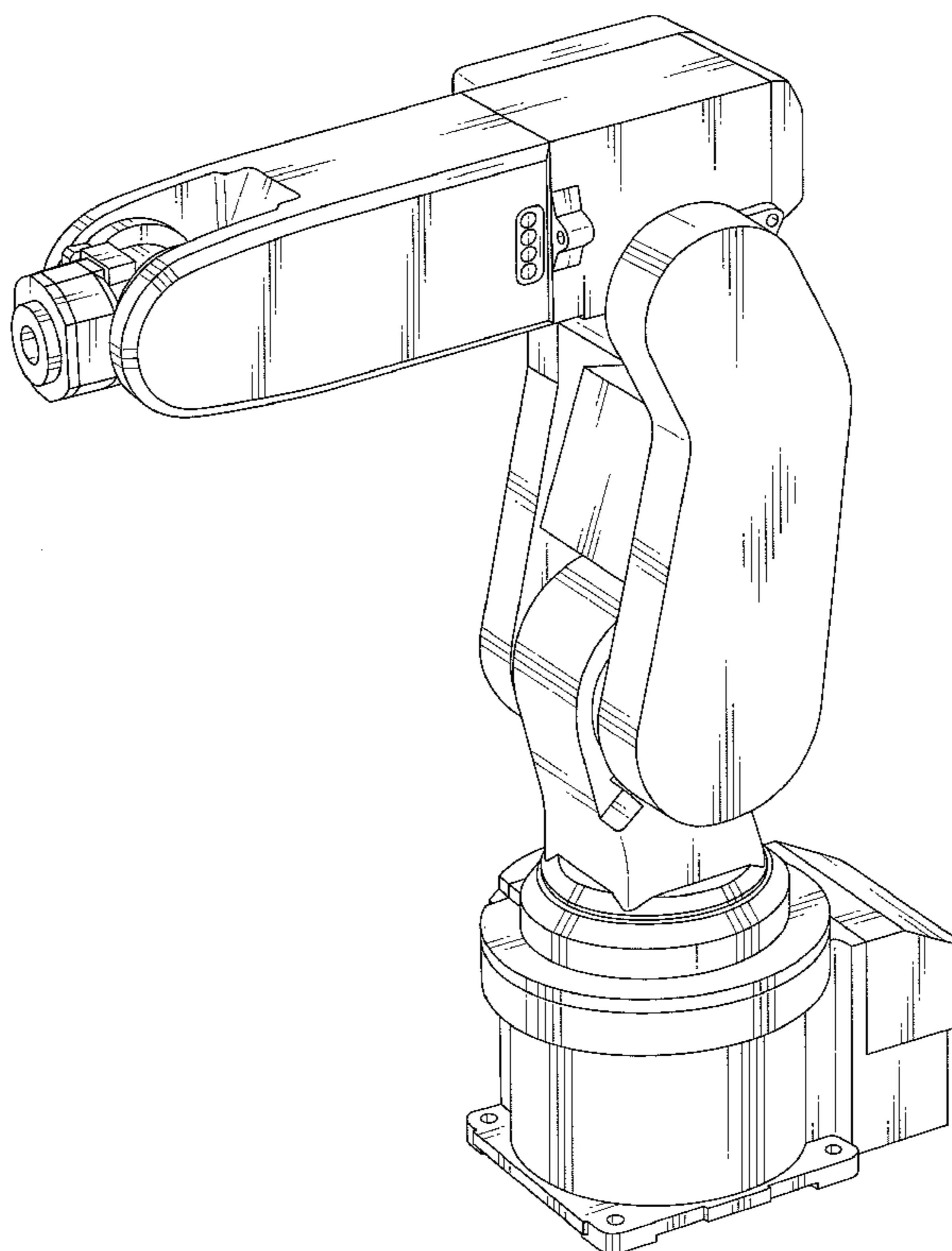

FIG. 1

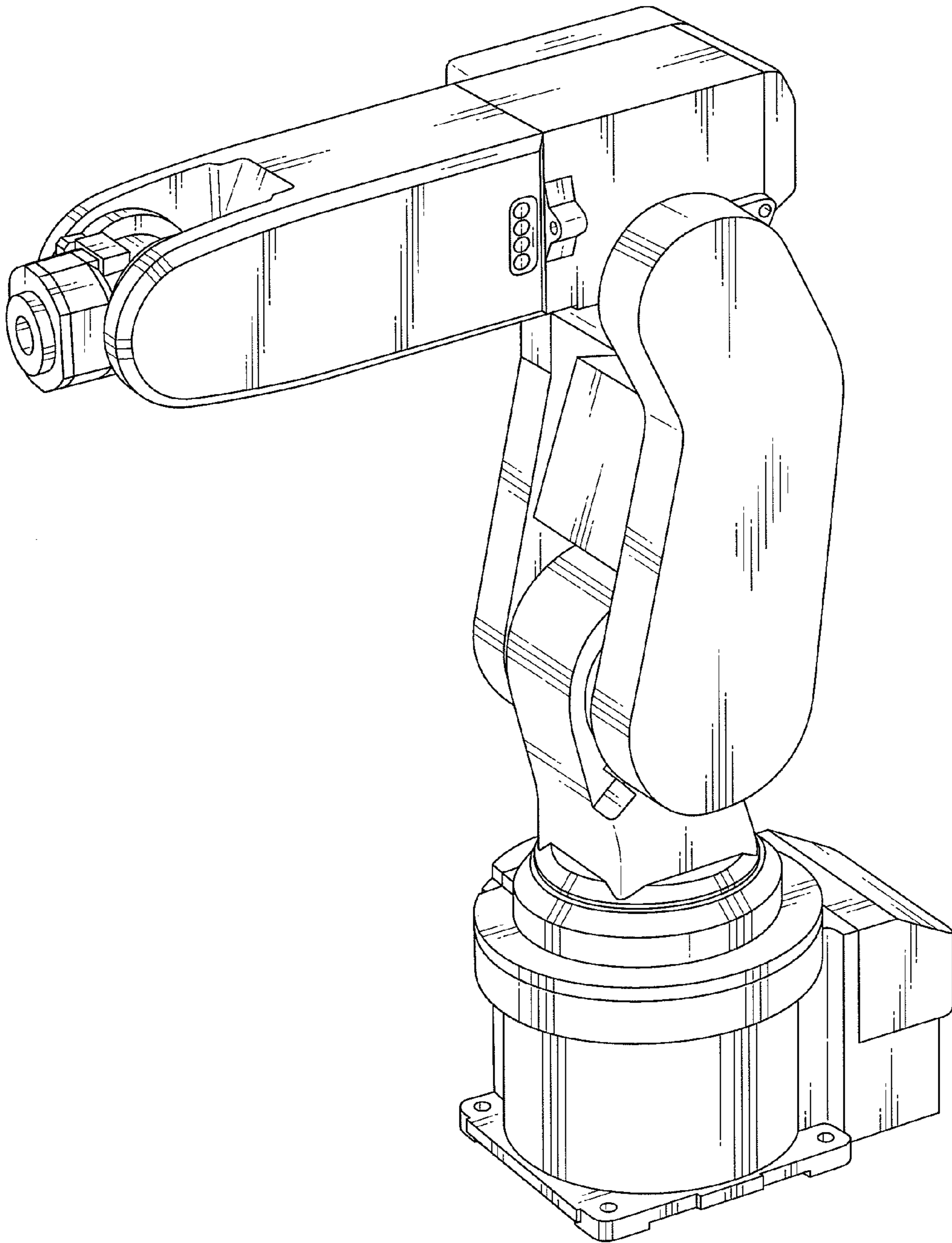

FIG.2

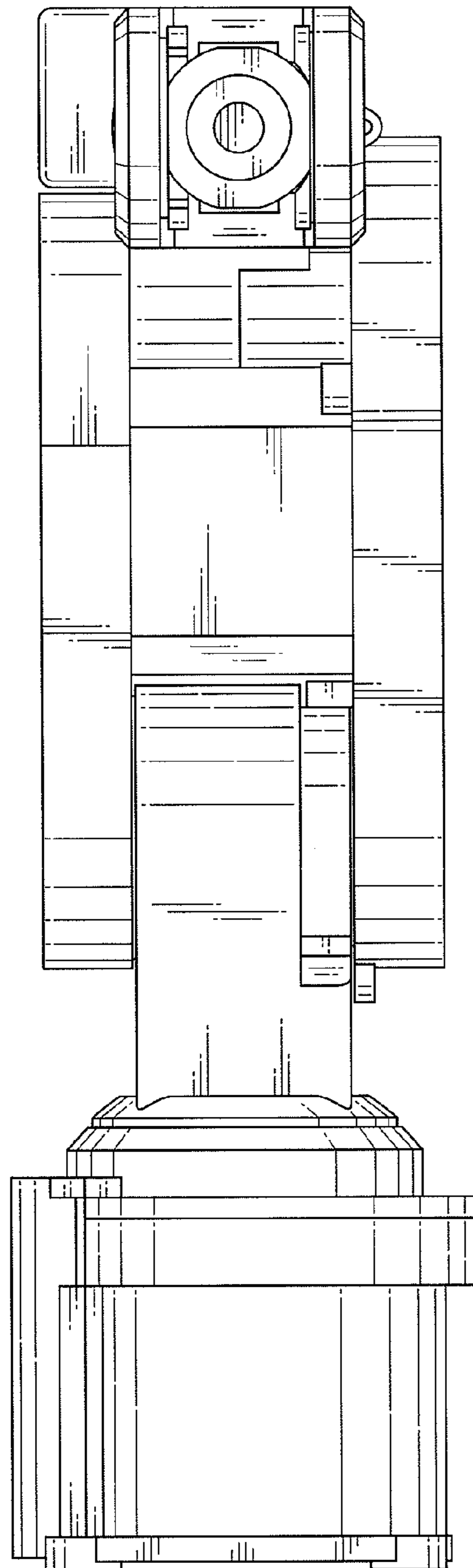

FIG.3

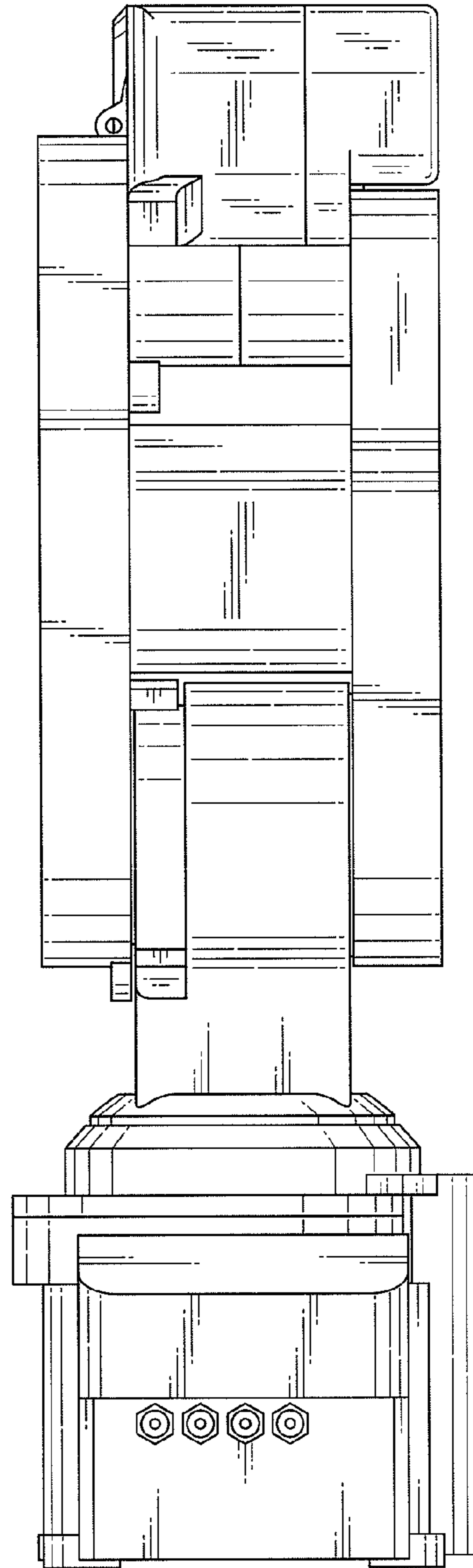

FIG.4

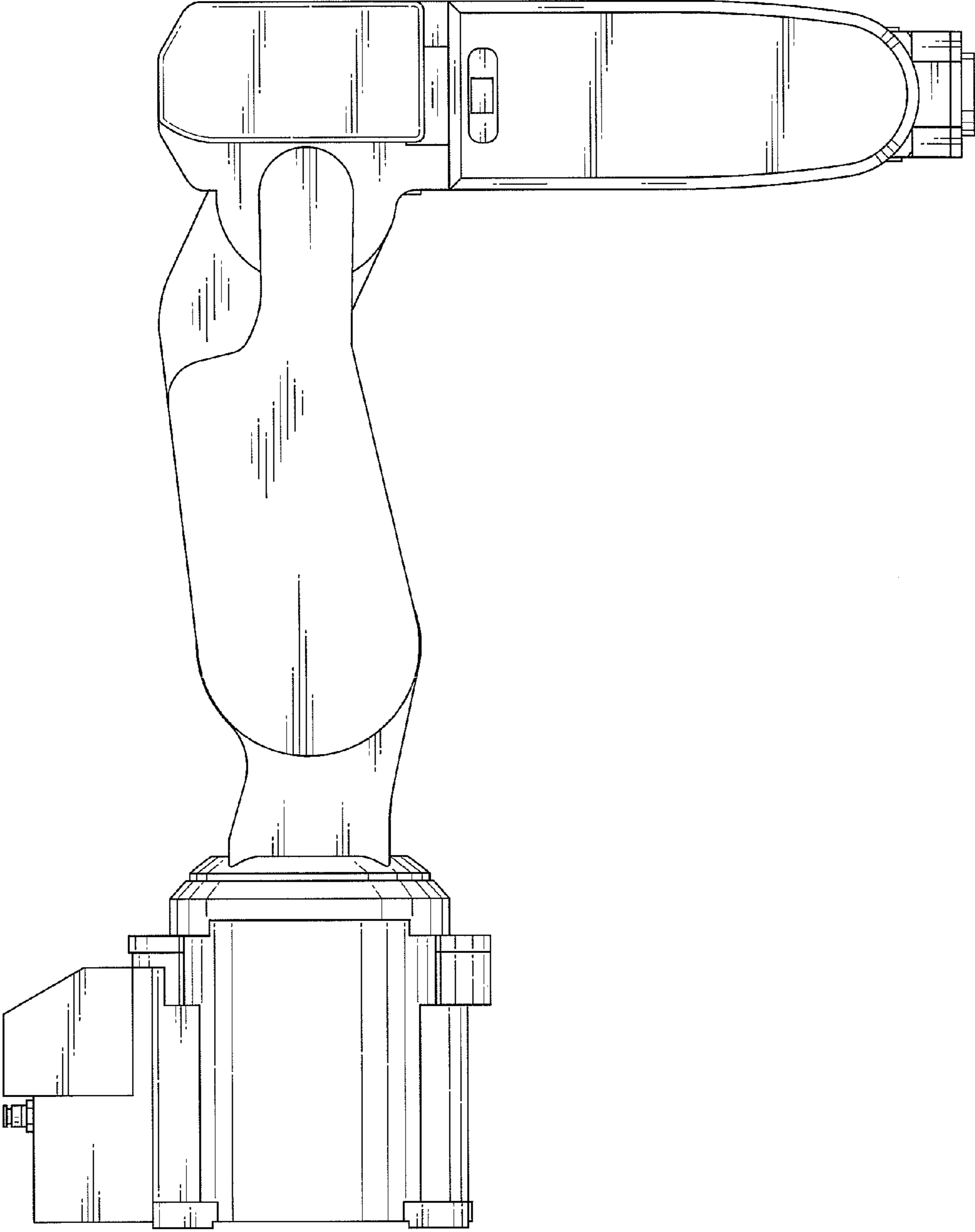

FIG.5

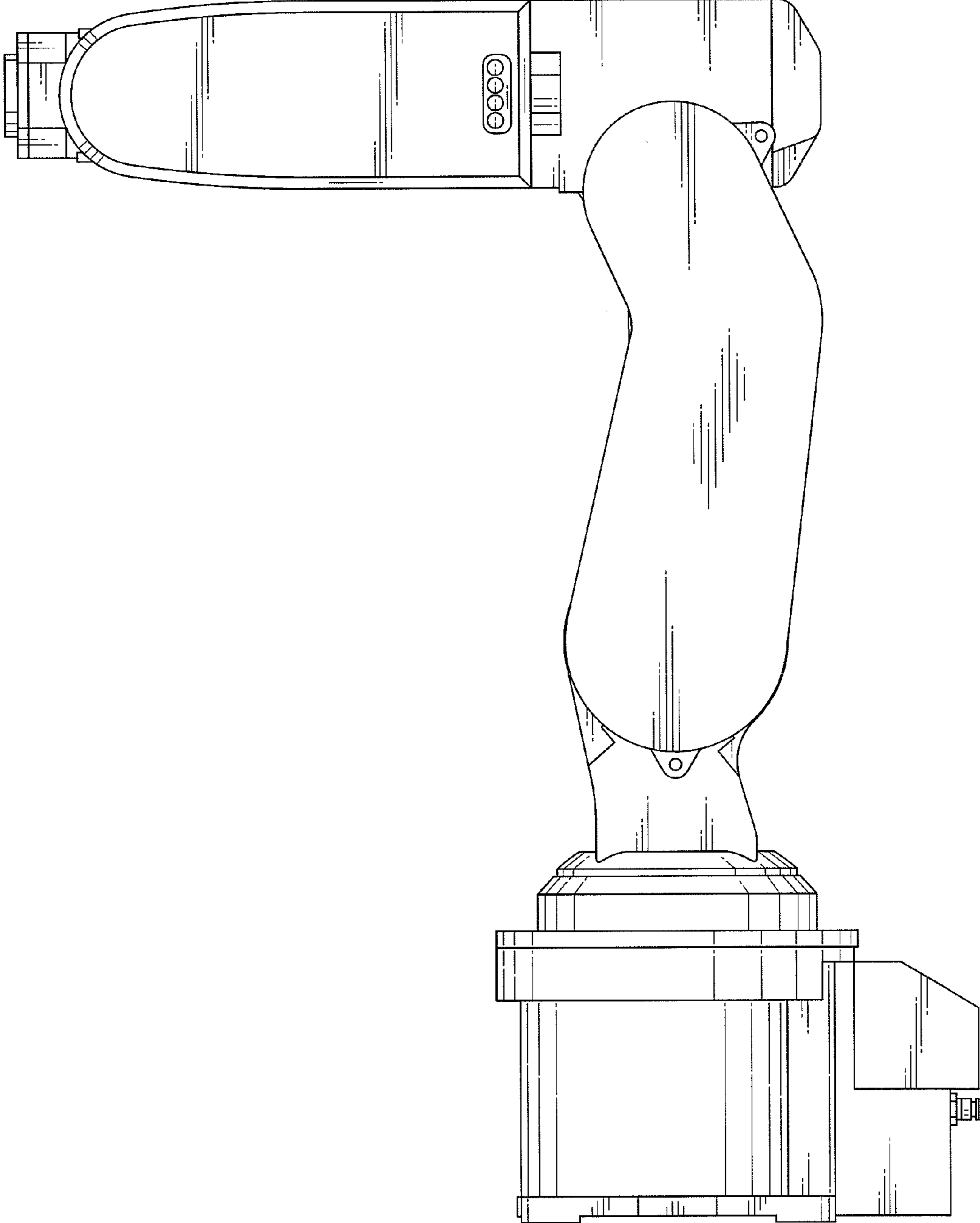

FIG.6

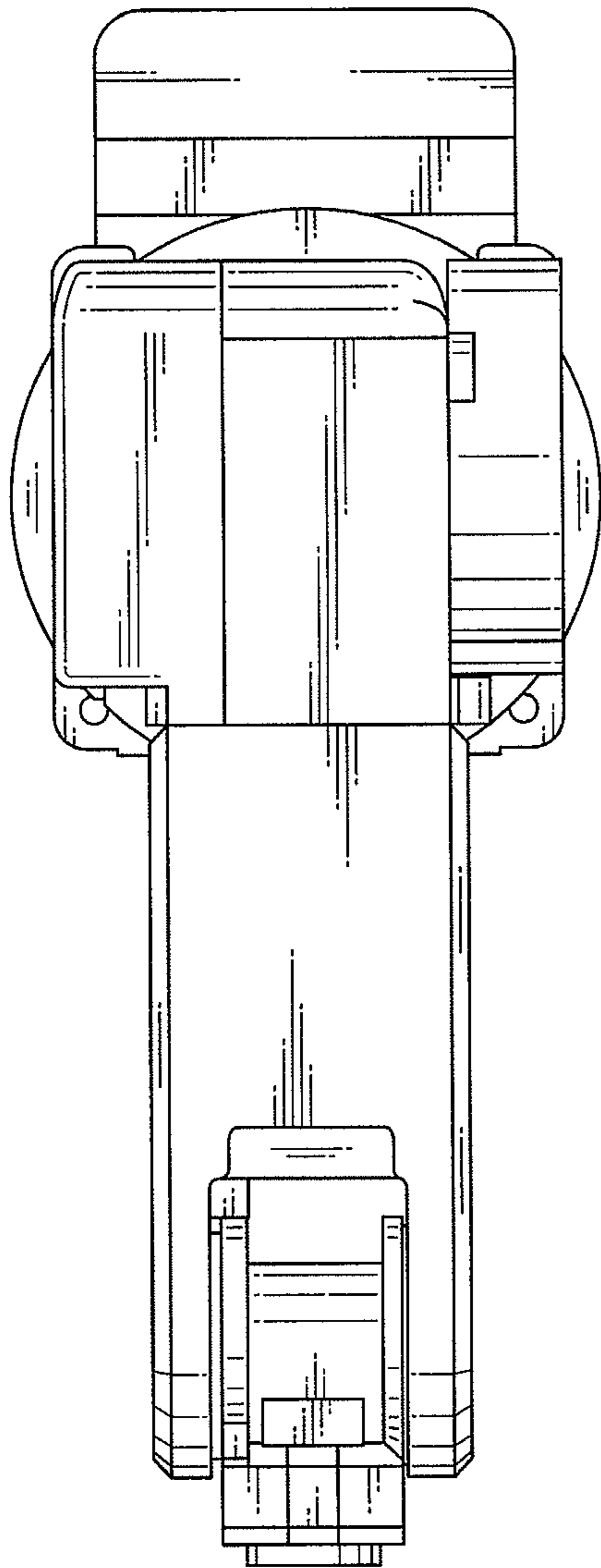

FIG.7

