



US00D624067S

(12) **United States Design Patent**
Peng

(10) **Patent No.:** **US D624,067 S**

(45) **Date of Patent:** **** Sep. 21, 2010**

(54) **SHELL OF RUGGED NOTEBOOK
COMPUTER**

(75) Inventor: **Po-Hsuan Peng**, Miaoli (TW)

(73) Assignee: **Getac Technology Corporation**,
Hsinchu (TW)

(**) Term: **14 Years**

(21) Appl. No.: **29/351,438**

(22) Filed: **Dec. 5, 2009**

(30) **Foreign Application Priority Data**

Oct. 15, 2009 (CN) 2009 3 0235736

(51) **LOC (9) Cl.** **14-02**

(52) **U.S. Cl.** **D14/315**

(58) **Field of Classification Search** D14/315-328,
D14/341-345; D18/1, 2, 7, 11; D3/276,
D3/282, 289, 294, 900; 345/102, 104, 156,
345/163, 168; 341/22, 23; 361/679.08, 679.09,
361/679.26, 679.27; 400/486, 489; 206/320
See application file for complete search history.

(56) **References Cited**

U.S. PATENT DOCUMENTS

D389,816 S * 1/1998 Horiki et al. D14/318
D456,398 S * 4/2002 Horiki D14/328
D498,753 S * 11/2004 Yamada D14/328
D516,553 S * 3/2006 Richardson et al. D14/341

D557,897 S * 12/2007 Richardson et al. D3/294
D558,754 S * 1/2008 Takemasa et al. D14/328
D565,561 S * 4/2008 Kaneshiro D14/315
D566,111 S * 4/2008 Nakagawa D14/315
D572,479 S * 7/2008 Buck et al. D3/282
D572,709 S * 7/2008 Nakagawa et al. D14/315
D586,798 S * 2/2009 Tanaka et al. D14/315
2004/0112776 A1 * 6/2004 Lord 206/320

* cited by examiner

Primary Examiner—Freda S Nunn

(57) **CLAIM**

The ornamental design for a shell of rugged notebook computer, as shown and described.

DESCRIPTION

FIG. 1 is a perspective view showing my new design;
FIG. 2 is a front elevational view thereof;
FIG. 3 is a rear elevational view thereof;
FIG. 4 is a right side elevational view thereof;
FIG. 5 is a left side elevational view thereof;
FIG. 6 is a top plan view thereof;
FIG. 7 is a bottom plan view thereof; and,
FIG. 8 is perspective view thereof illustrating environment
structure in broken lines.

The broken lines which illustrate the environmental structure
of the claimed design form no part thereof.

1 Claim, 6 Drawing Sheets

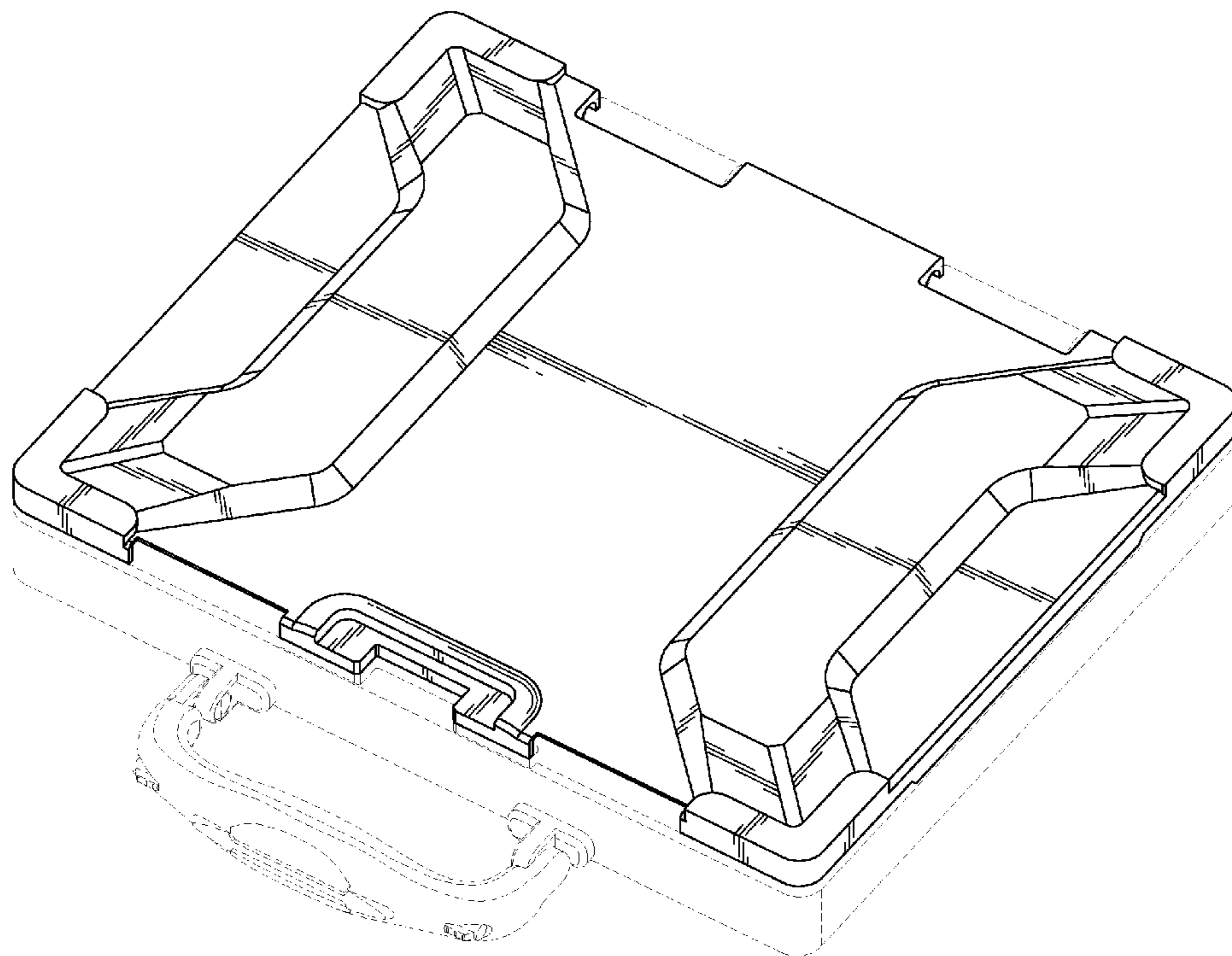

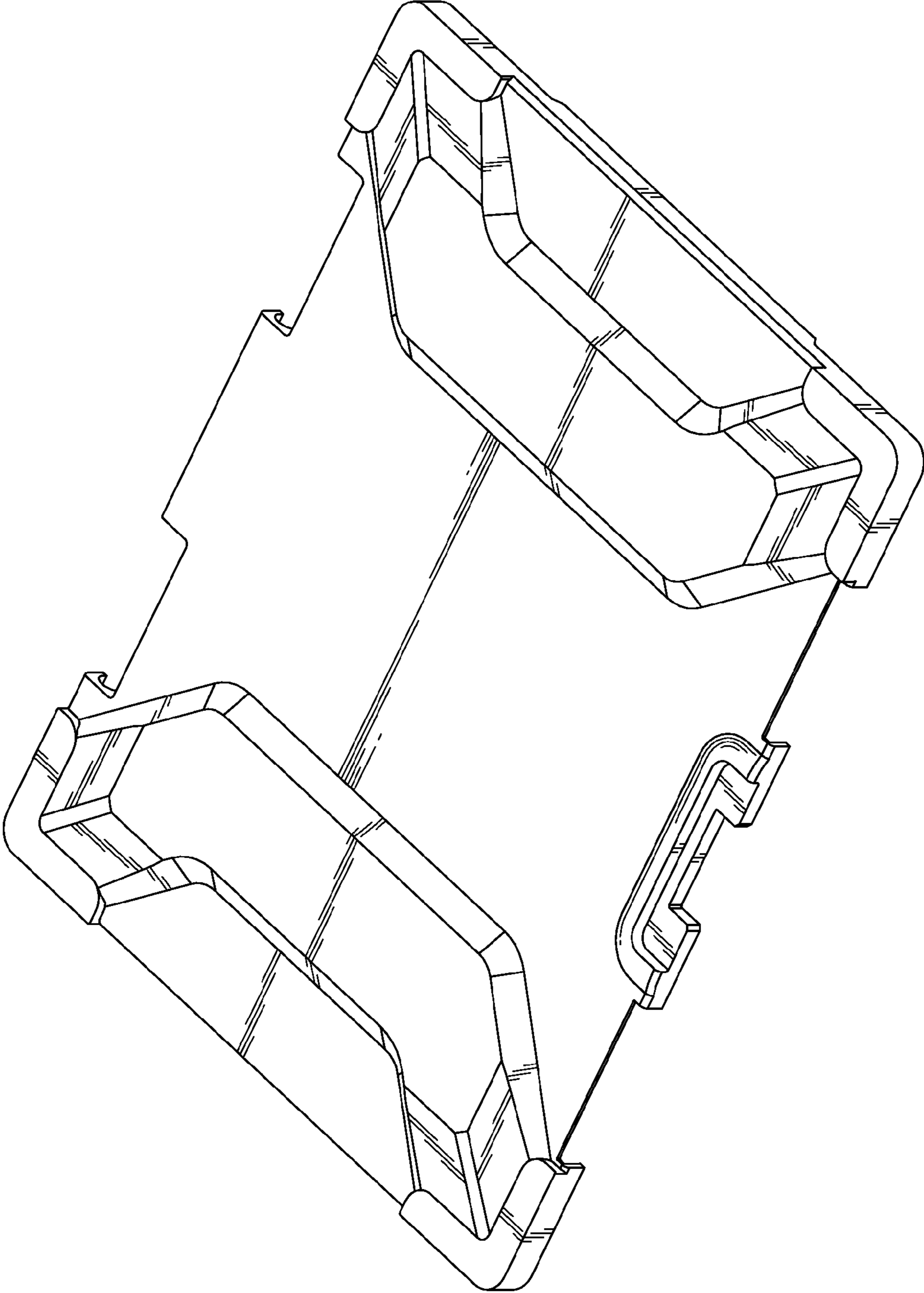

FIG.1

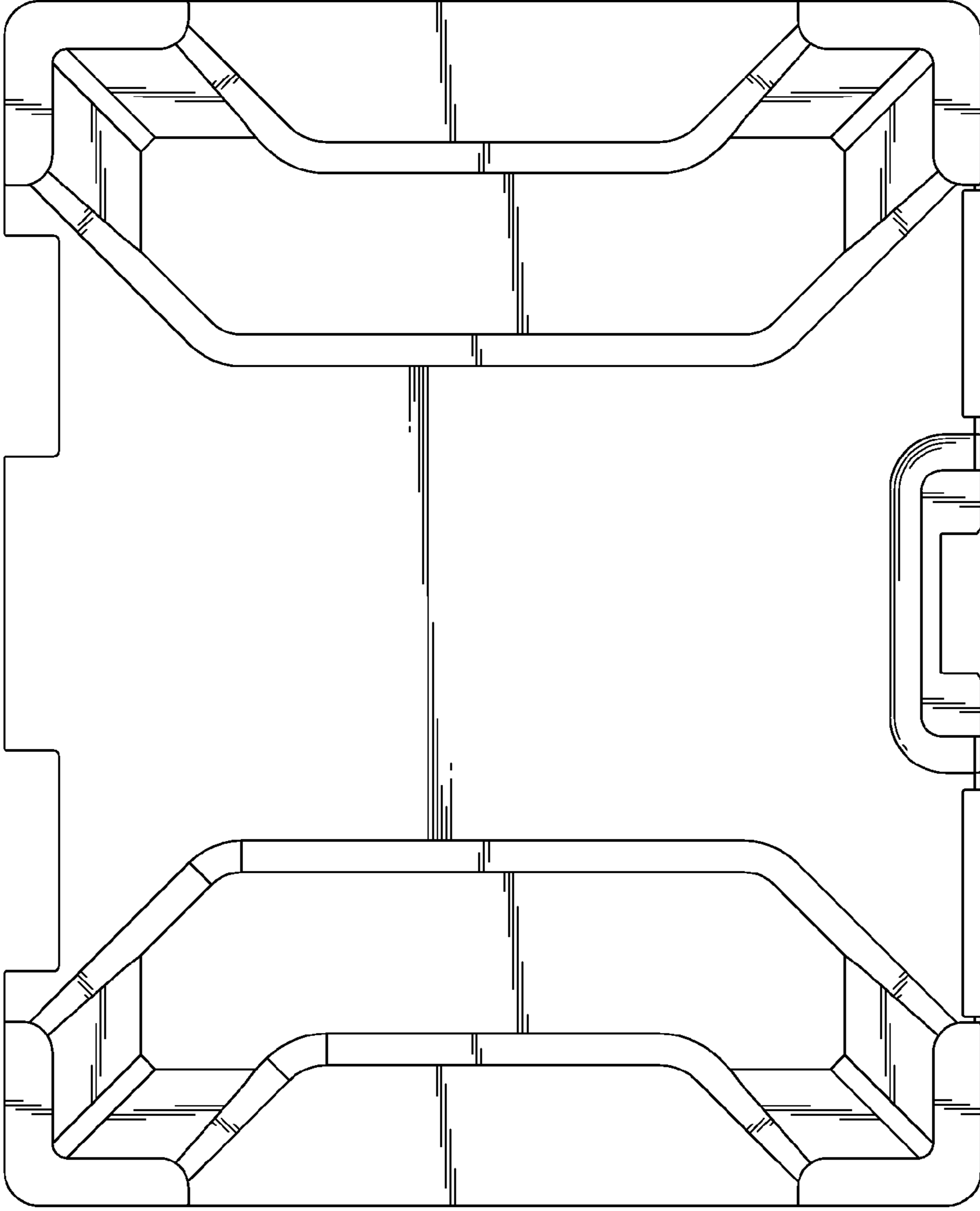

FIG.2

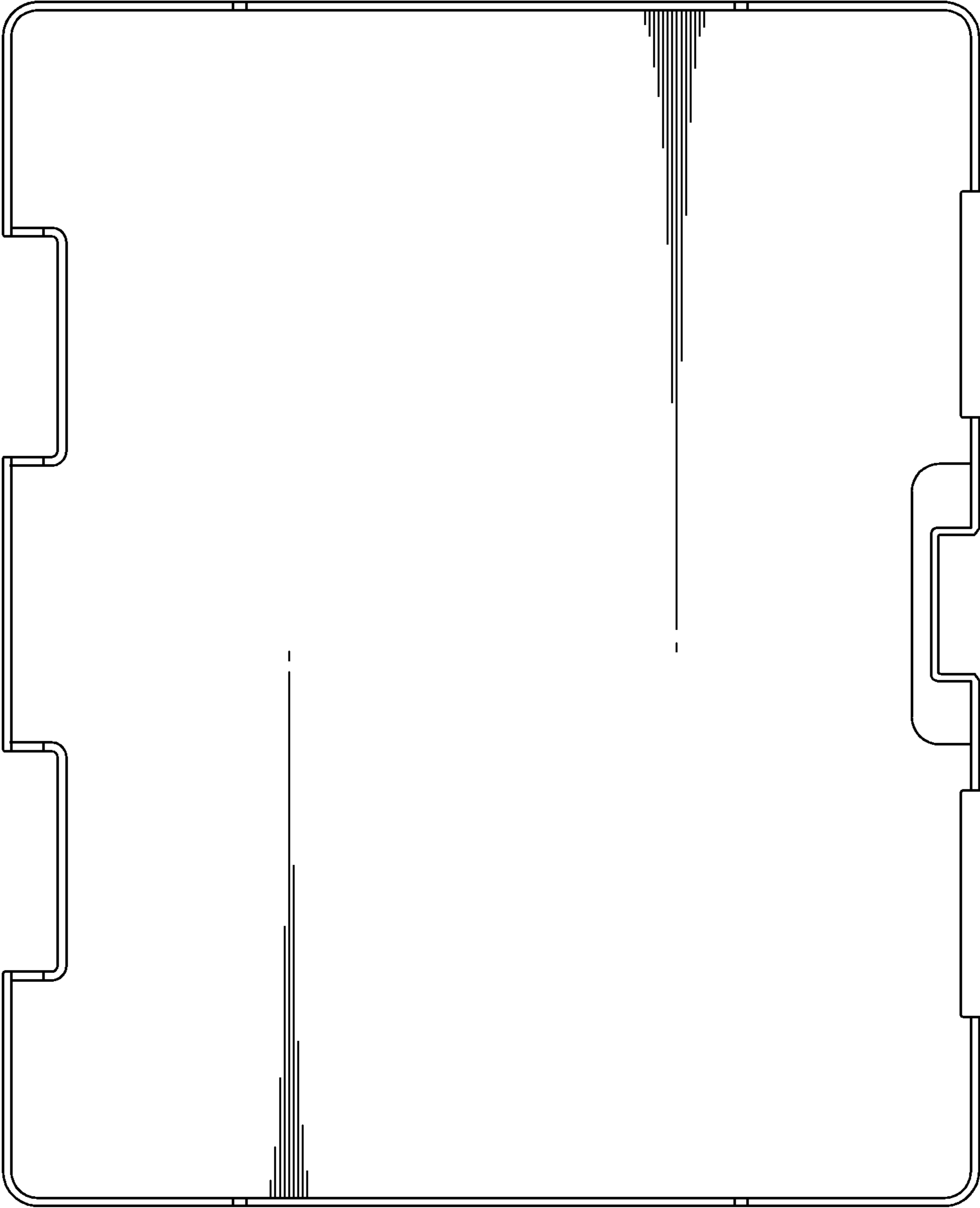

FIG.3

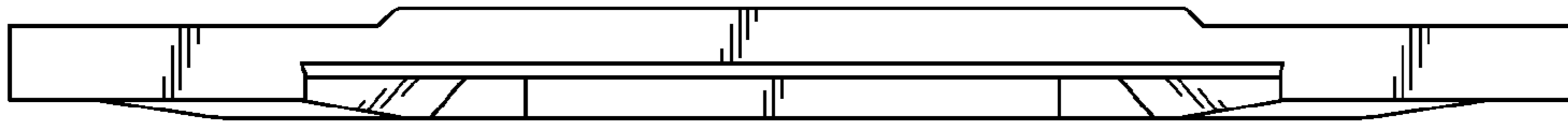

FIG.5



FIG.4

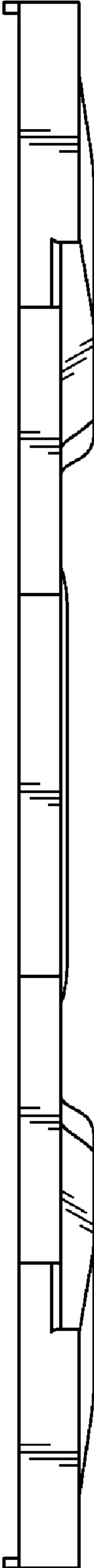

FIG. 6

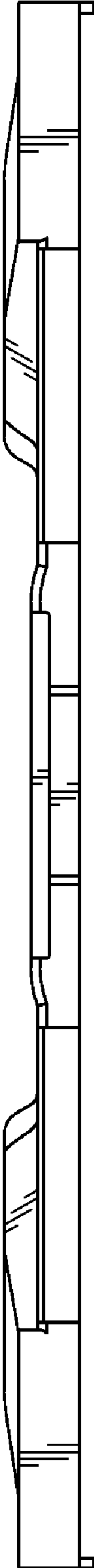

FIG. 7

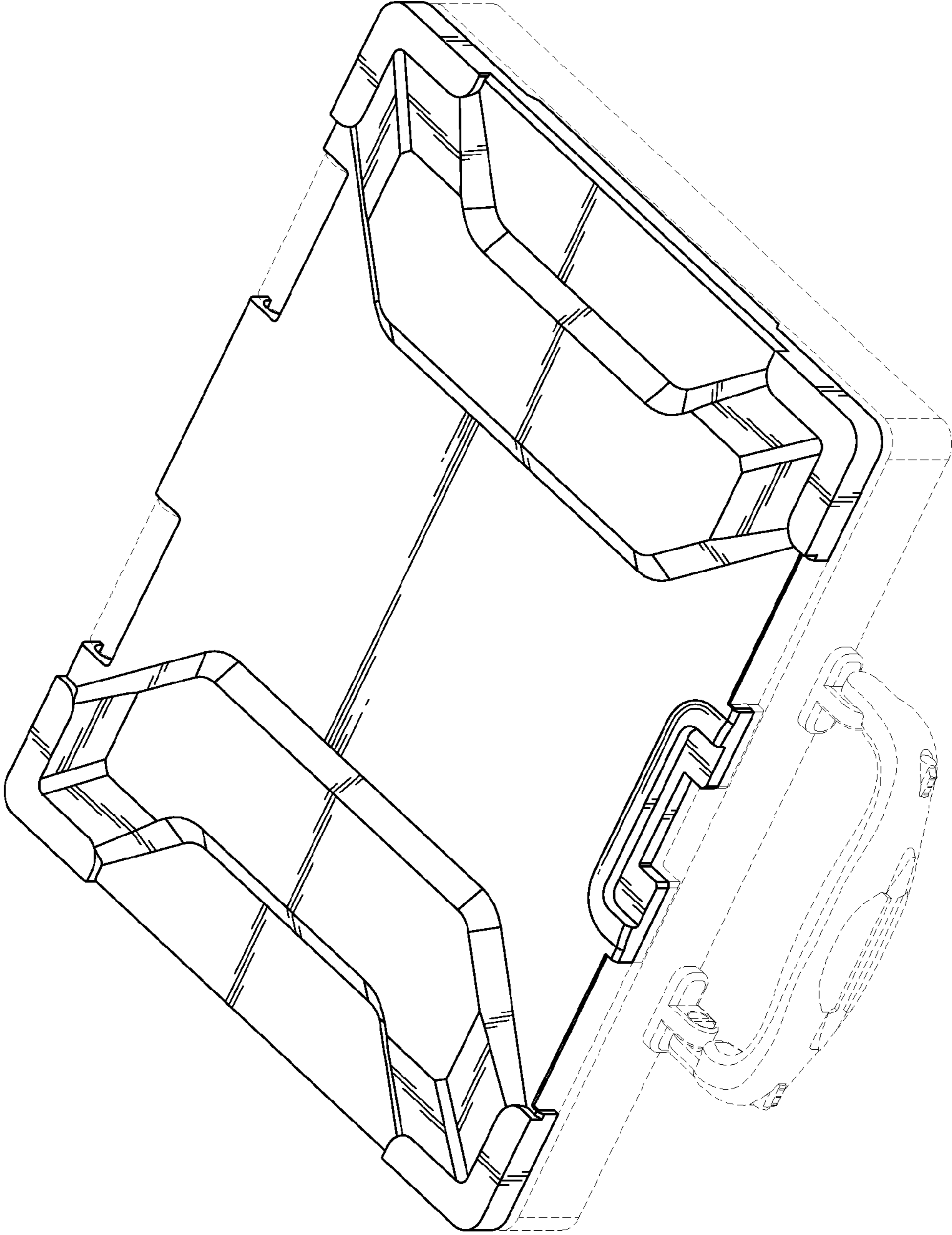

FIG.8