



US00D624045S

(12) **United States Design Patent**  
**Lee et al.**

(10) **Patent No.:** **US D624,045 S**  
(45) **Date of Patent:** **\*\* Sep. 21, 2010**

(54) **CELLULAR PHONE**

(75) Inventors: **Hye-Jeong Lee**, Seoul (KR); **Nam-Mi Kim**, Seoul (KR); **Chang-Hwan Hwang**, Seongnam-si (KR)

(73) Assignee: **Samsung Electronics Co., Ltd.**,  
Maetan-dong, Yeongtong-gu, Suwon-si,  
Gyeonggi-do (KR)

(\*\*) Term: **14 Years**

(21) Appl. No.: **29/356,834**

(22) Filed: **Mar. 3, 2010**

(51) **LOC (9) Cl.** ..... **14-03**

(52) **U.S. Cl.** ..... **D14/138 G**

(58) **Field of Classification Search** ..... D14/138 R,  
D14/138 AD, 138 AC, 138 C, 138 G, 191,  
D14/203.1–203.8, 496, 138 AA, 138 AB,  
D14/247–248, 137, 147, 218, 341–347; D10/65,  
D10/78, 104; D13/168; D18/7; 455/566,  
455/575.1, 575.3

See application file for complete search history.

(56) **References Cited**

**U.S. PATENT DOCUMENTS**

D466,096 S *	11/2002	Takada	.....	D14/138 AD
D503,699 S *	4/2005	Lee et al.	.....	D14/138 AD
D509,202 S *	9/2005	Lee et al.	.....	D14/138 AD
D527,366 S *	8/2006	Lee	.....	D14/138 AD
D528,526 S *	9/2006	Shin	.....	D14/138 AD
D548,213 S *	8/2007	Lee et al.	.....	D14/138 AC
D554,097 S *	10/2007	Lee	.....	D14/138 AD
D559,220 S *	1/2008	Lee et al.	.....	D14/138 AD
D560,192 S *	1/2008	Lee et al.	.....	D14/138 AD
D565,533 S *	4/2008	Kim et al.	.....	D14/138 AD
7,372,413 B2 *	5/2008	Chang	.....	343/702
D575,762 S *	8/2008	Ou	.....	D14/138 G
D581,385 S *	11/2008	Park et al.	.....	D14/138 AD
D597,508 S *	8/2009	Kim et al.	.....	D14/138 AD
D601,538 S *	10/2009	Hong	.....	D14/138 G
D603,356 S *	11/2009	Sterzick et al.	.....	D14/138 G

D612,824 S *	3/2010	Kim et al.	.....	D14/138 AD
D615,055 S *	5/2010	Lee et al.	.....	D14/138 G
D615,950 S *	5/2010	Cha et al.	.....	D14/138 AD
D616,852 S *	6/2010	Kim et al.	.....	D14/138 AD
D616,855 S *	6/2010	Song et al.	.....	D14/138 AD
D619,557 S *	7/2010	Han et al.	.....	D14/138 AD
D619,984 S *	7/2010	Han et al.	.....	D14/138 AD
D619,986 S *	7/2010	Kim et al.	.....	D14/138 AD
2005/0107119 A1 *	5/2005	Lee et al.	.....	455/556.1
2006/0093133 A1 *	5/2006	Park et al.	.....	379/433.12

**OTHER PUBLICATIONS**

Samsung B5722, announced Nov. 2009, [online], [retrieved on Nov. 25, 2009]. Retrieved from Internet ,<URL: <http://www.gsmarena.com>>.\*

Samsung T749 Highlight, announced Jun. 2009, [online], [retrieved on Jul. 20, 2009]. Retrieved from Internet ,<URL: <http://www.gsmarena.com>>.\*

LG GW620, announced Sep. 2009, [online], [retrieved on Sep. 14, 2009]. Retrieved from Internet ,<URL: <http://www.gsmarena.com>>.\*

\* cited by examiner

*Primary Examiner*—Bridget L Eland

(74) *Attorney, Agent, or Firm*—Lexyoume IP Group, PLLC.

(57) **CLAIM**

The ornamental design for a cellular phone, as shown and described.

**DESCRIPTION**

FIG. 1 is a perspective view of a cellular phone showing our new design;

FIG. 2 is a front elevational view thereof;

FIG. 3 is a rear elevational view thereof;

FIG. 4 is a left side elevational view thereof;

FIG. 5 is a right side elevational view thereof;

FIG. 6 is a top plan view thereof; and,

FIG. 7 is a bottom plan view thereof.

**1 Claim, 7 Drawing Sheets**

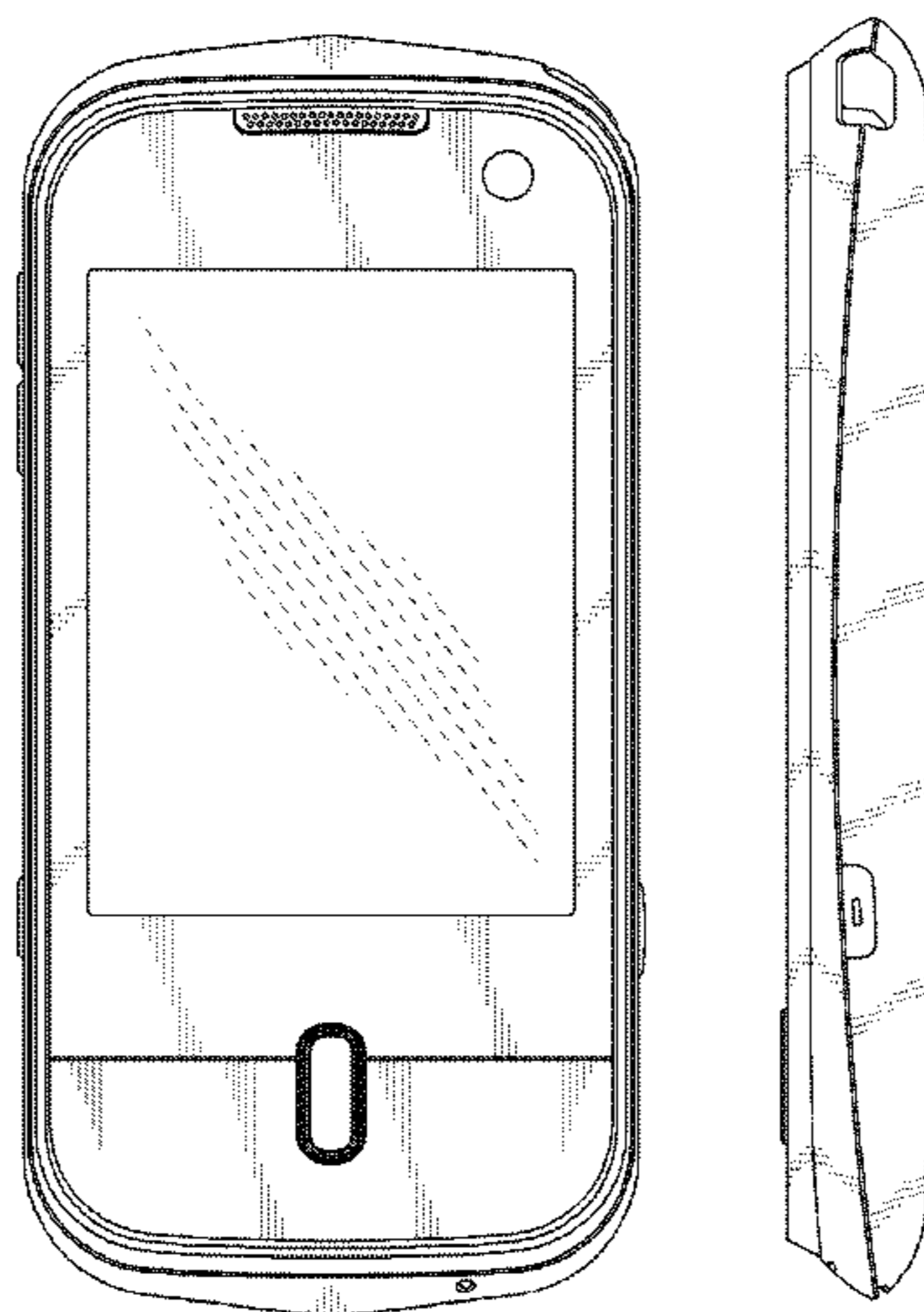

FIG.1

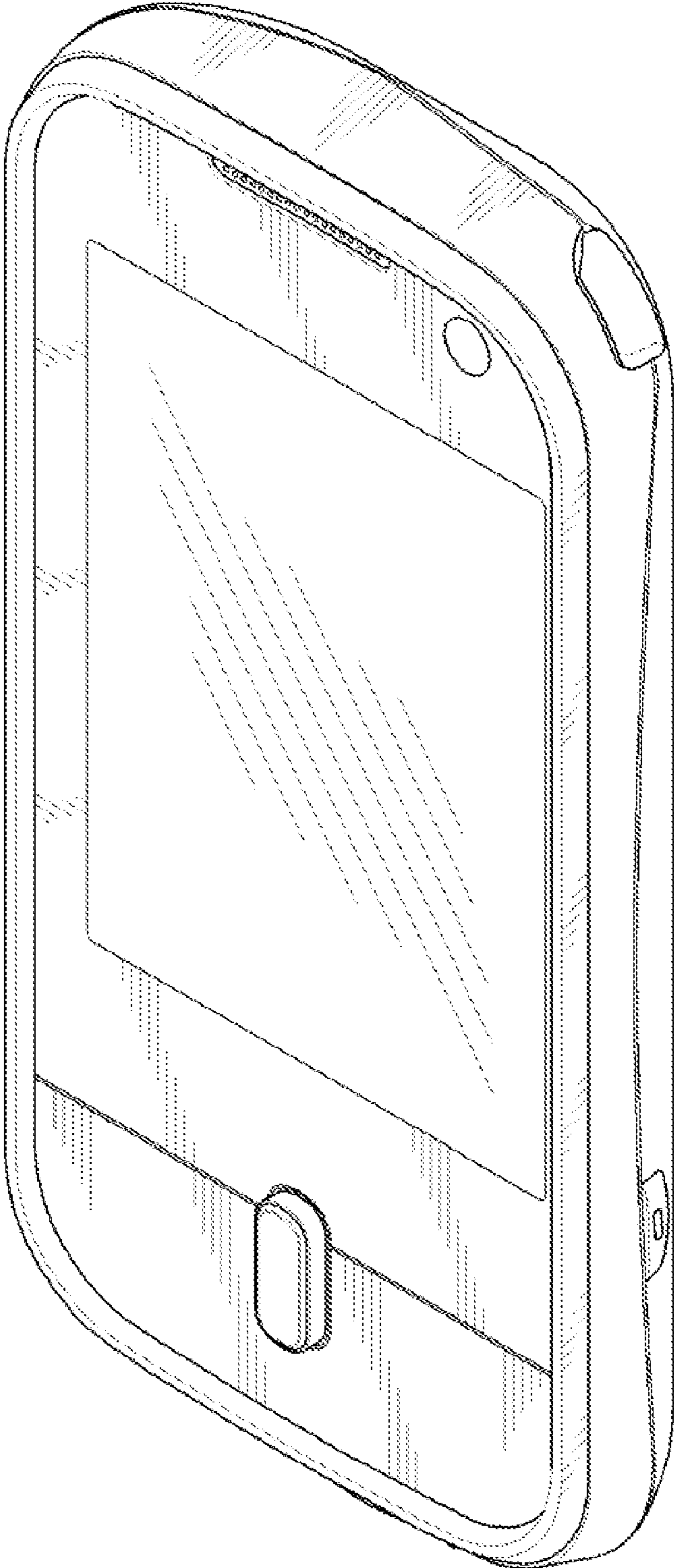

FIG.2

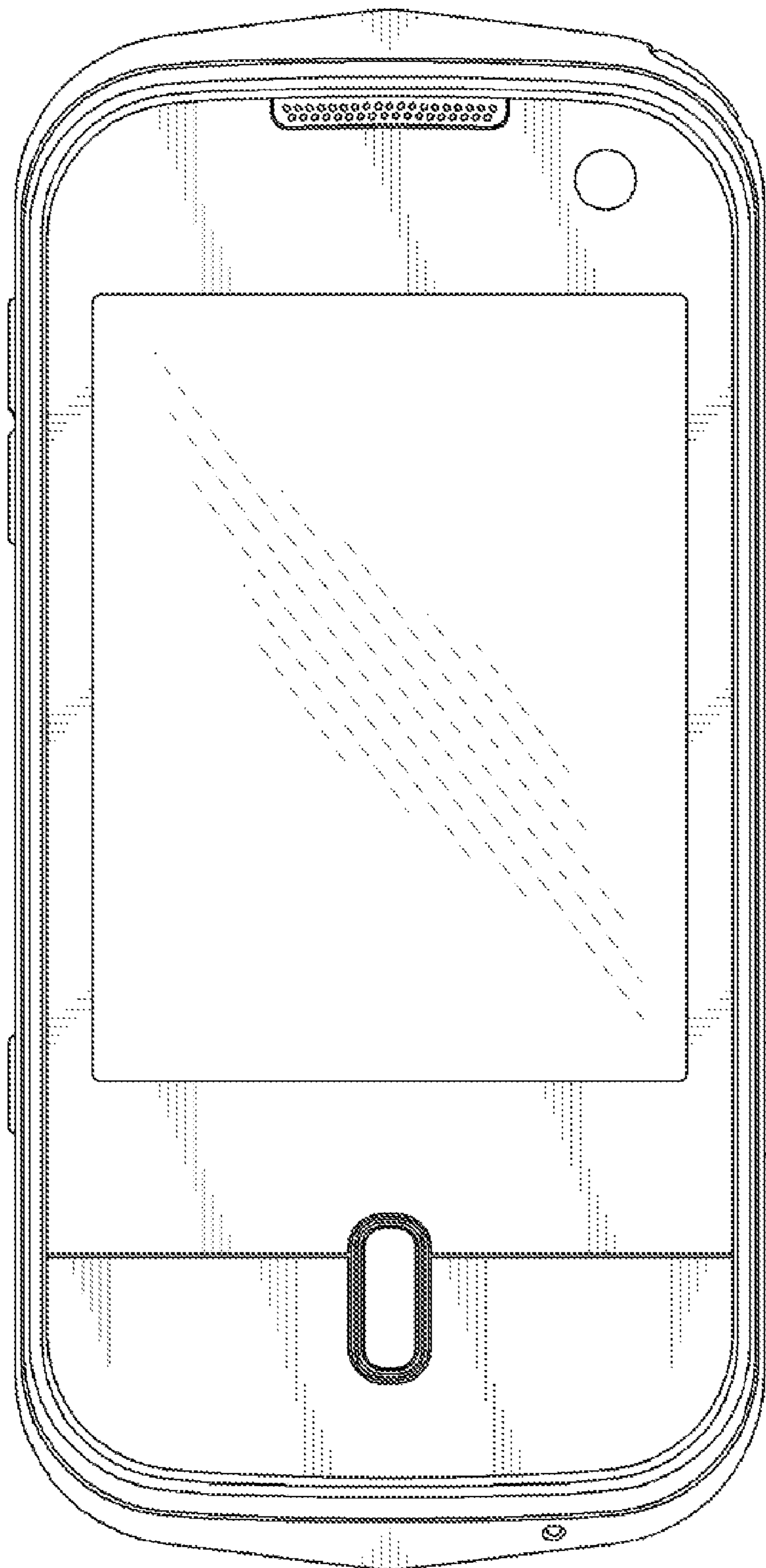

FIG.3

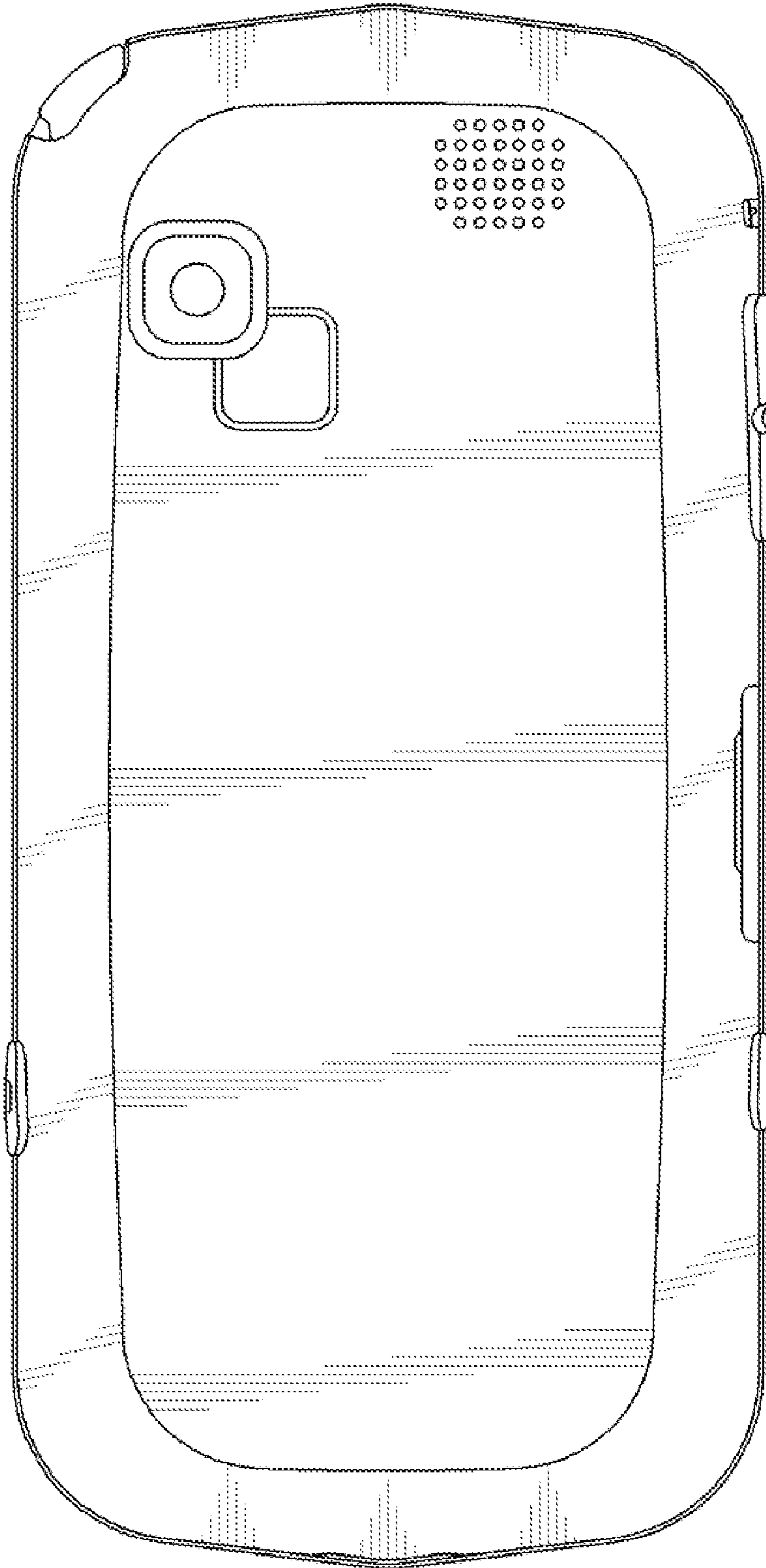

FIG. 4

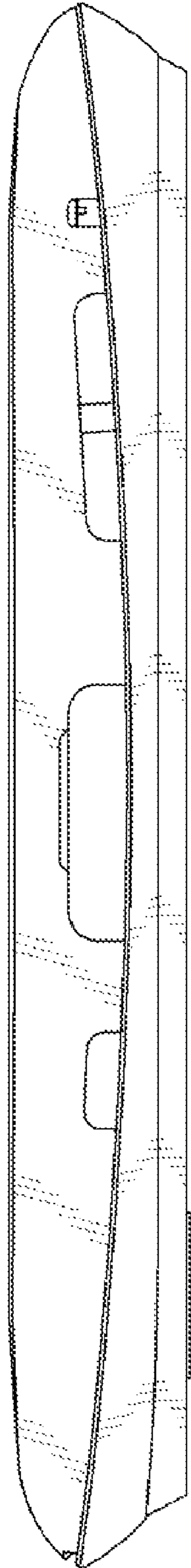

FIG.5

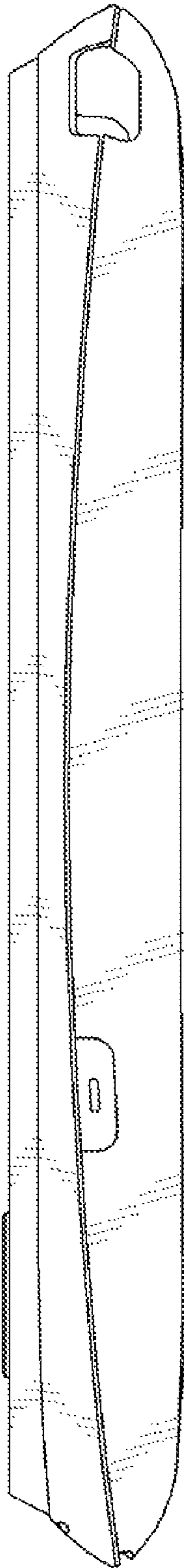

FIG. 6

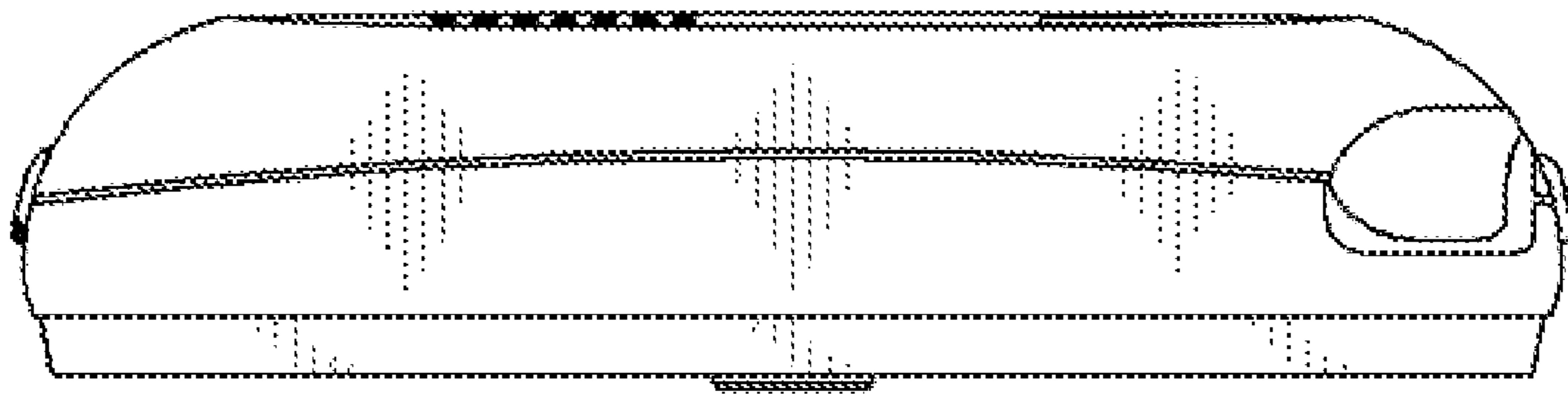

FIG. 7

