



US00D624013S

(12) **United States Design Patent**
Lingott

(10) **Patent No.:** **US D624,013 S**

(45) **Date of Patent:** **** Sep. 21, 2010**

(54) **BATTERY CHARGER**

(75) Inventor: **Philippe Lingott**, Essen (DE)

(73) Assignee: **Robert Bosch GmbH**, Stuttgart (DE)

(**) Term: **14 Years**

(21) Appl. No.: **29/359,351**

(22) Filed: **Apr. 9, 2010**

(30) **Foreign Application Priority Data**

Nov. 18, 2009 (EM) 001178818

(51) **LOC (9) Cl.** **13-02**

(52) **U.S. Cl.** **D13/107**

(58) **Field of Classification Search** D13/107-110,
D13/118-119, 184, 199; D14/251, 253,
D14/432, 434; 320/107-115
See application file for complete search history.

(56) **References Cited**

U.S. PATENT DOCUMENTS

D374,426 S	*	10/1996	Nuovo	D13/108
D465,451 S	*	11/2002	Hirano et al.	D13/107
D505,915 S	*	6/2005	Hussaini et al.	D13/110
D537,410 S	*	2/2007	Yuen	D13/110
D543,503 S	*	5/2007	Suzuki	D13/110
D556,678 S	*	12/2007	Weinstein et al.	D13/103

D556,679 S	*	12/2007	Weinstein et al.	D13/103
D570,772 S	*	6/2008	Mahaffey et al.	D13/110
D575,225 S	*	8/2008	Ahlgren	D13/107
D580,853 S	*	11/2008	Ahlgren	D13/107
D581,356 S	*	11/2008	Ahlgren	D13/107
D612,329 S	*	3/2010	Guccione et al.	D13/108
D617,267 S	*	6/2010	Li	D13/107

* cited by examiner

Primary Examiner—Rosemary K Tarcza

(74) *Attorney, Agent, or Firm*—Victor A. Henzi

(57) **CLAIM**

The ornamental design for the battery charger, as shown and described.

DESCRIPTION

FIG. 1 is a right elevational view of the battery charger;
FIG. 2 is a left elevational view thereof;
FIG. 3 is a front elevational view thereof;
FIG. 4 is a rear elevational view thereof;
FIG. 5 is a top plan view thereof; and,
FIG. 6 is a bottom plan view thereof.

The broken lines are for the purpose of illustrating environmental structure and form no part of the claimed design.

1 Claim, 5 Drawing Sheets

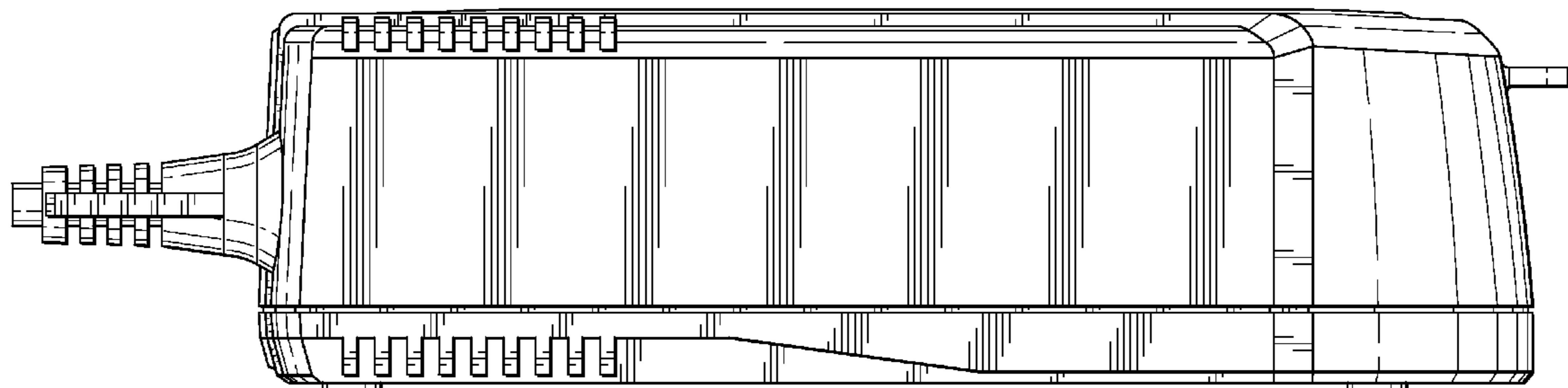

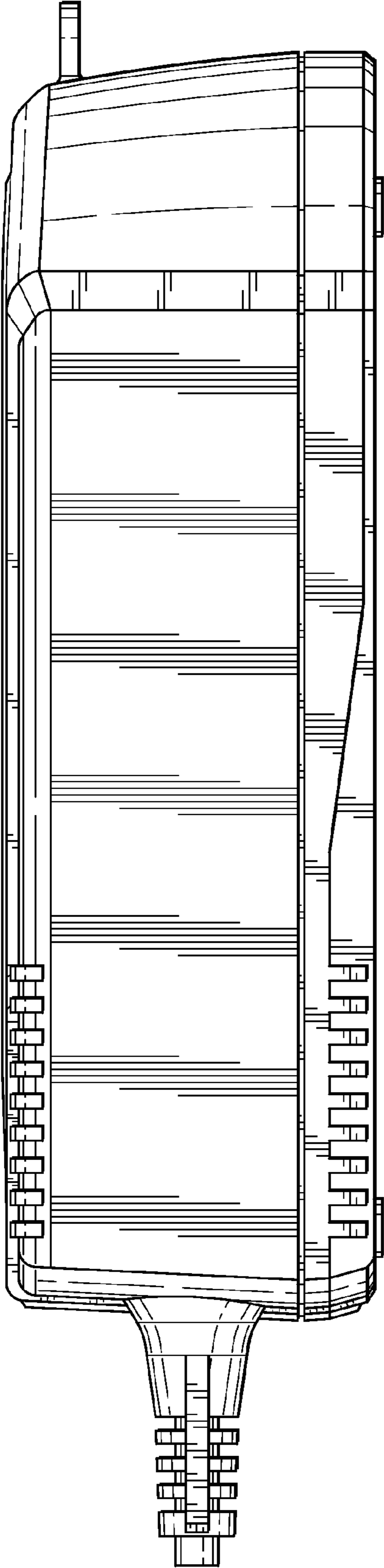

Fig. 1

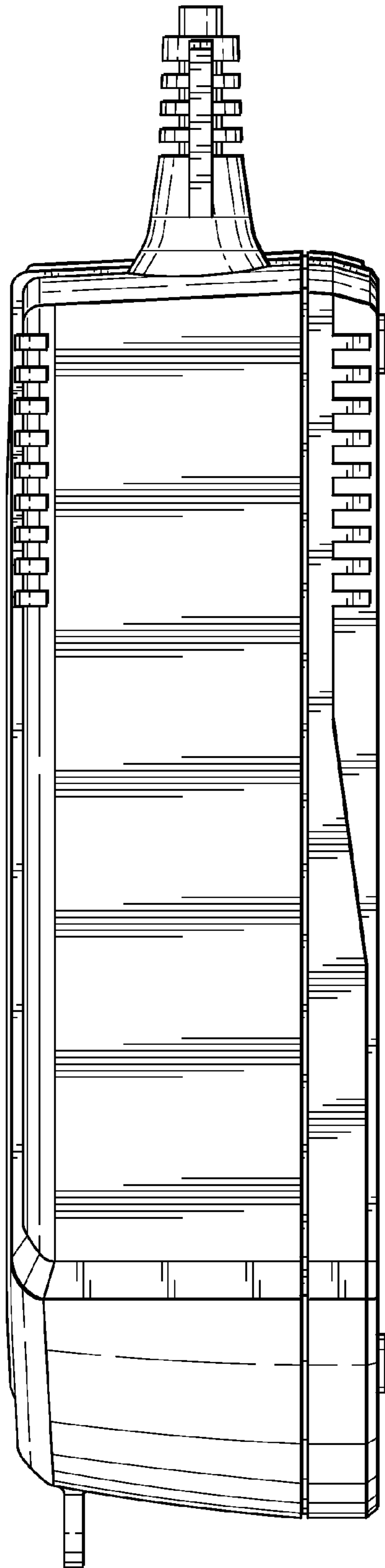

Fig. 2

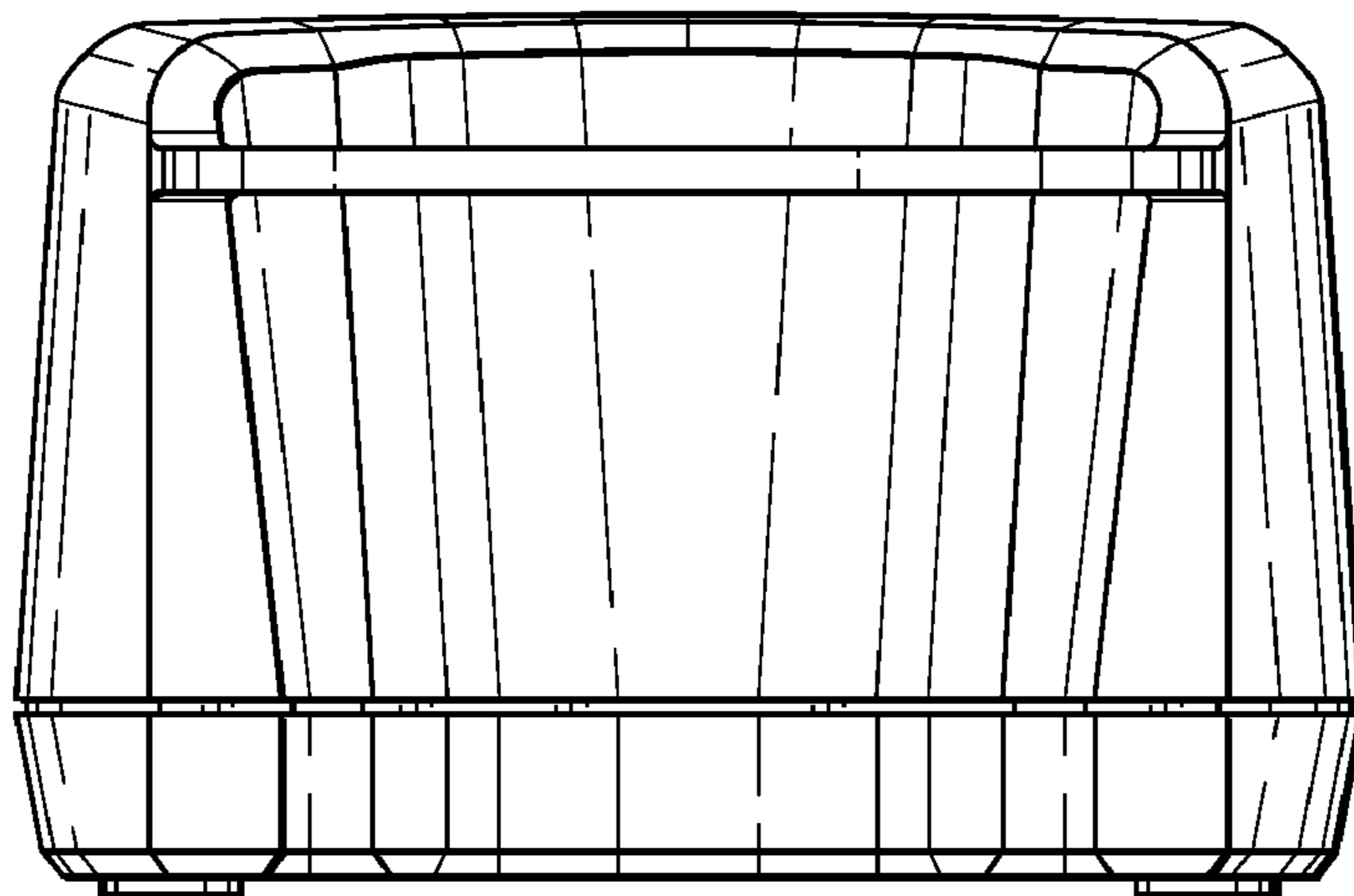

Fig. 3

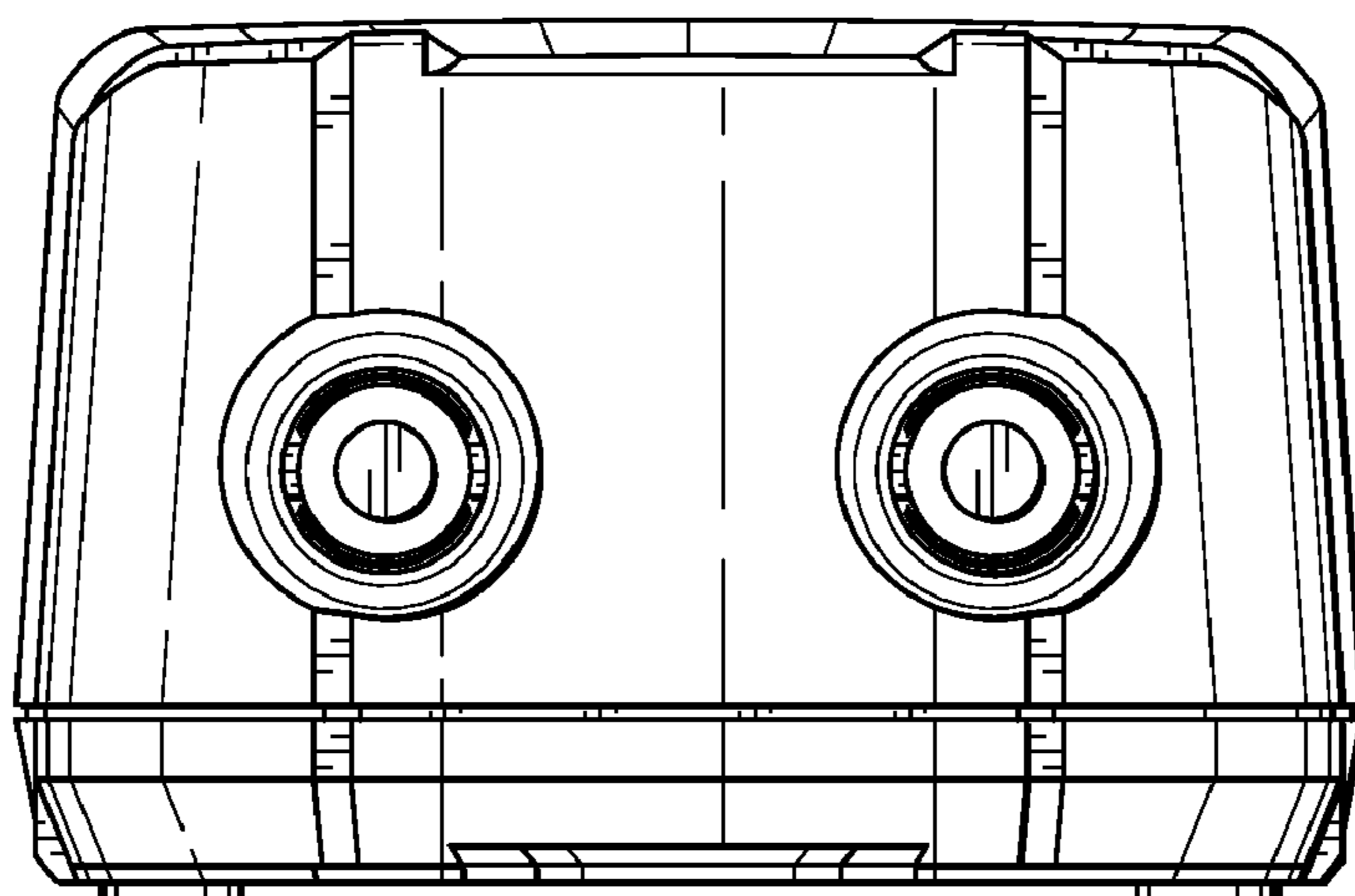

Fig. 4

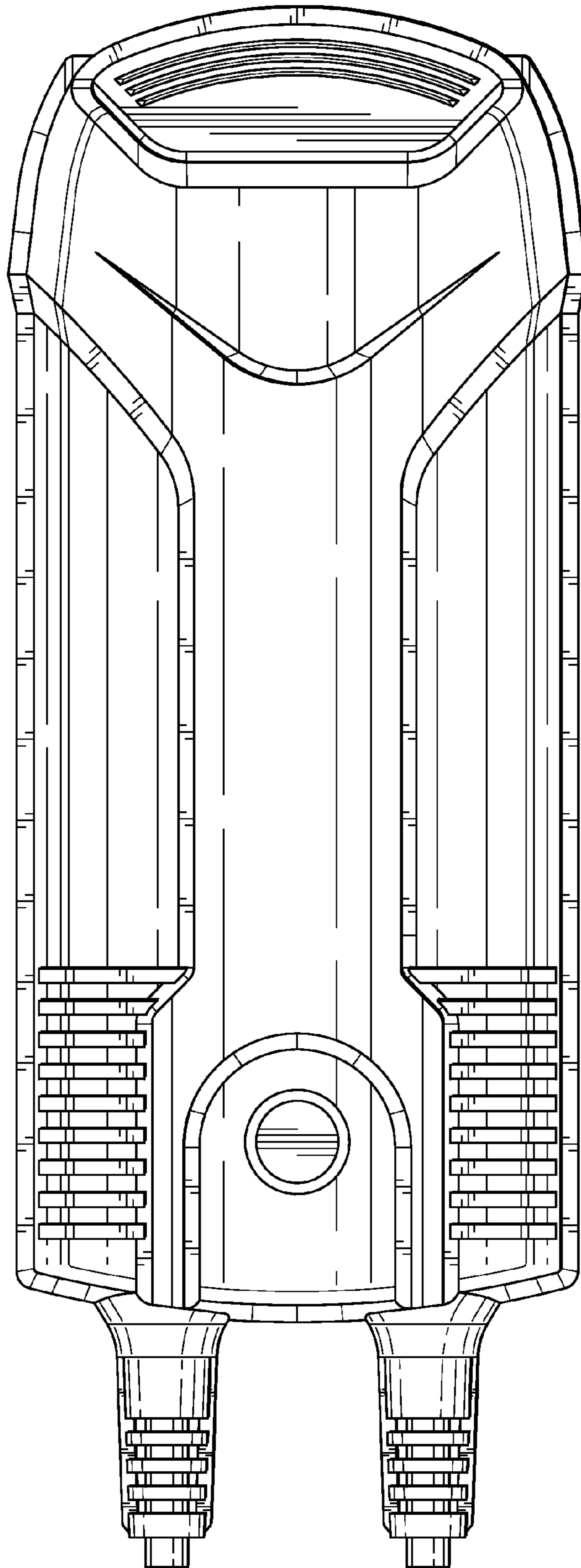

Fig. 5

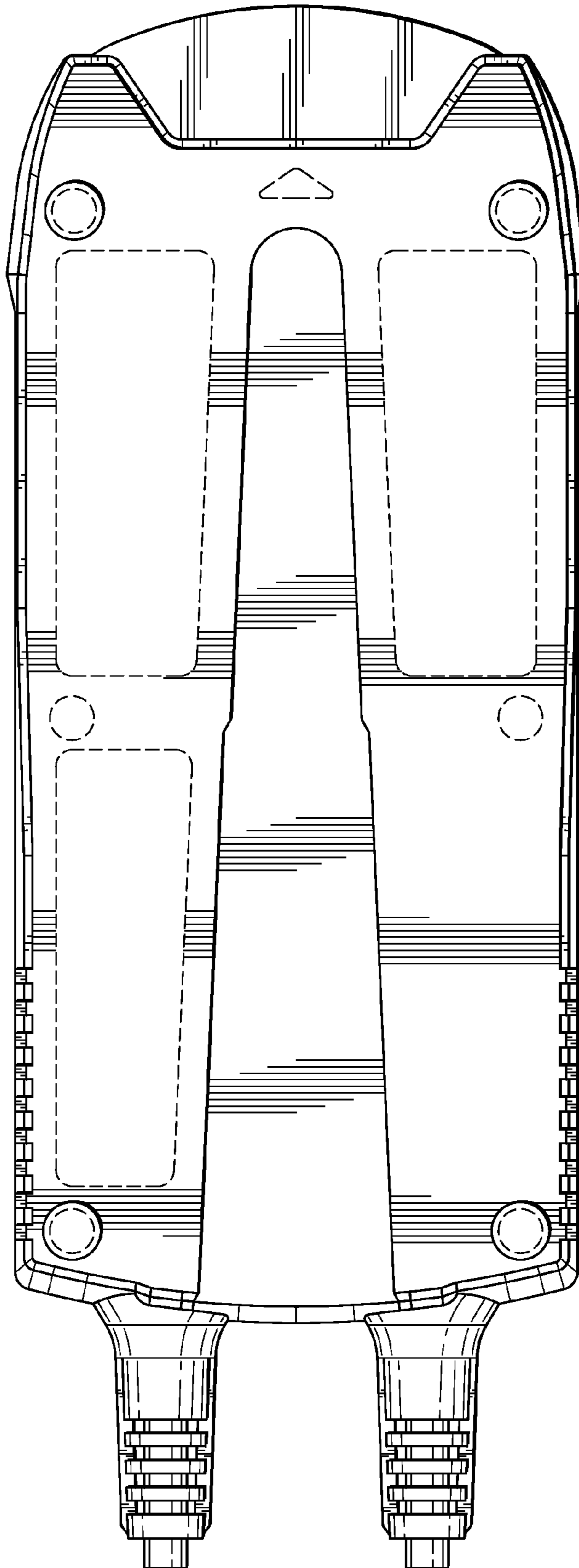

Fig. 6