



US00D623967S

(12) **United States Design Patent**  
**Shupp**

(10) **Patent No.:** **US D623,967 S**

(45) **Date of Patent:** **\*\* Sep. 21, 2010**

(54) **MULTI-FUNCTION SPORTS AND RECREATION DEVICE**

(76) Inventor: **William A. Shupp**, 27 Ebony Oaks Pl.,  
The Woodlands, TX (US) 77382

(\*\*) Term: **14 Years**

(21) Appl. No.: **29/343,532**

(22) Filed: **Sep. 15, 2009**

(51) **LOC (9) Cl.** ..... **10-03**

(52) **U.S. Cl.** ..... **D10/40; D10/2; D10/31;**  
D10/119

(58) **Field of Classification Search** ..... D10/40,  
D10/2, 31, 119; 368/278, 10, 11, 14; 116/137 R  
See application file for complete search history.

(56) **References Cited**

**U.S. PATENT DOCUMENTS**

D238,760	S	*	2/1976	Dunn	.....	D10/40
4,100,728	A	*	7/1978	Chang et al.	.....	368/101
D266,492	S	*	10/1982	Oppermann et al.	.....	D10/119
D267,785	S	*	2/1983	Heuer	.....	D10/30
4,451,158	A	*	5/1984	Selwyn et al.	.....	368/63
D279,173	S	*	6/1985	Ketcham	.....	D10/40
4,709,651	A	*	12/1987	Lance	.....	116/137 R
4,821,670	A	*	4/1989	Foxcroft et al.	.....	116/137 R
D301,014	S	*	5/1989	Houlihan	.....	D10/30
D319,788	S	*	9/1991	Fukazawa	.....	D10/30
D320,357	S	*	10/1991	Mizukami	.....	D10/30
D346,336	S	*	4/1994	Meyers	.....	D10/53
D389,747	S	*	1/1998	Ramos et al.	.....	D10/30
D393,597	S	*	4/1998	Pail	.....	D10/30
D396,193	S	*	7/1998	Pail	.....	D10/30
D410,771	S	*	6/1999	Chang	.....	D3/208
D419,891	S	*	2/2000	Chan	.....	D10/5
D424,452	S	*	5/2000	Li	.....	D10/40

D433,340	S	*	11/2000	Lo	.....	D10/2
D439,170	S	*	3/2001	Chan	.....	D10/30
D439,171	S	*	3/2001	Wa	.....	D10/30
D451,404	S	*	12/2001	Dobashi	.....	D10/30
D455,729	S	*	4/2002	Chen	.....	D14/170
6,603,711	B2	*	8/2003	Calace	.....	368/109
D489,273	S	*	5/2004	Chan	.....	D10/40
D502,421	S	*	3/2005	Cheng	.....	D10/119
7,043,802	B2	*	5/2006	Moeller et al.	.....	24/429
7,125,145	B2	*	10/2006	Gardiner et al.	.....	362/253
D539,687	S	*	4/2007	Chen	.....	D10/119
D556,619	S	*	12/2007	Markfelder	.....	D10/116
D574,822	S	*	8/2008	Bhavnani	.....	D14/356
D583,260	S	*	12/2008	Shih	.....	D10/40
7,581,509	B2	*	9/2009	Eventoff	.....	116/137 R
7,616,098	B2	*	11/2009	Al-Sabah	.....	340/323 R

\* cited by examiner

*Primary Examiner*—Lucy Lieberman

(74) *Attorney, Agent, or Firm*—Tim Headley

(57) **CLAIM**

The ornamental design for a multi-function sports and recreation device, as shown and described.

**DESCRIPTION**

FIG. 1 is a perspective view of an ornamental design for a multi-function sports and recreation device;

FIG. 2 is a right side view thereof;

FIG. 3 is a left side view thereof;

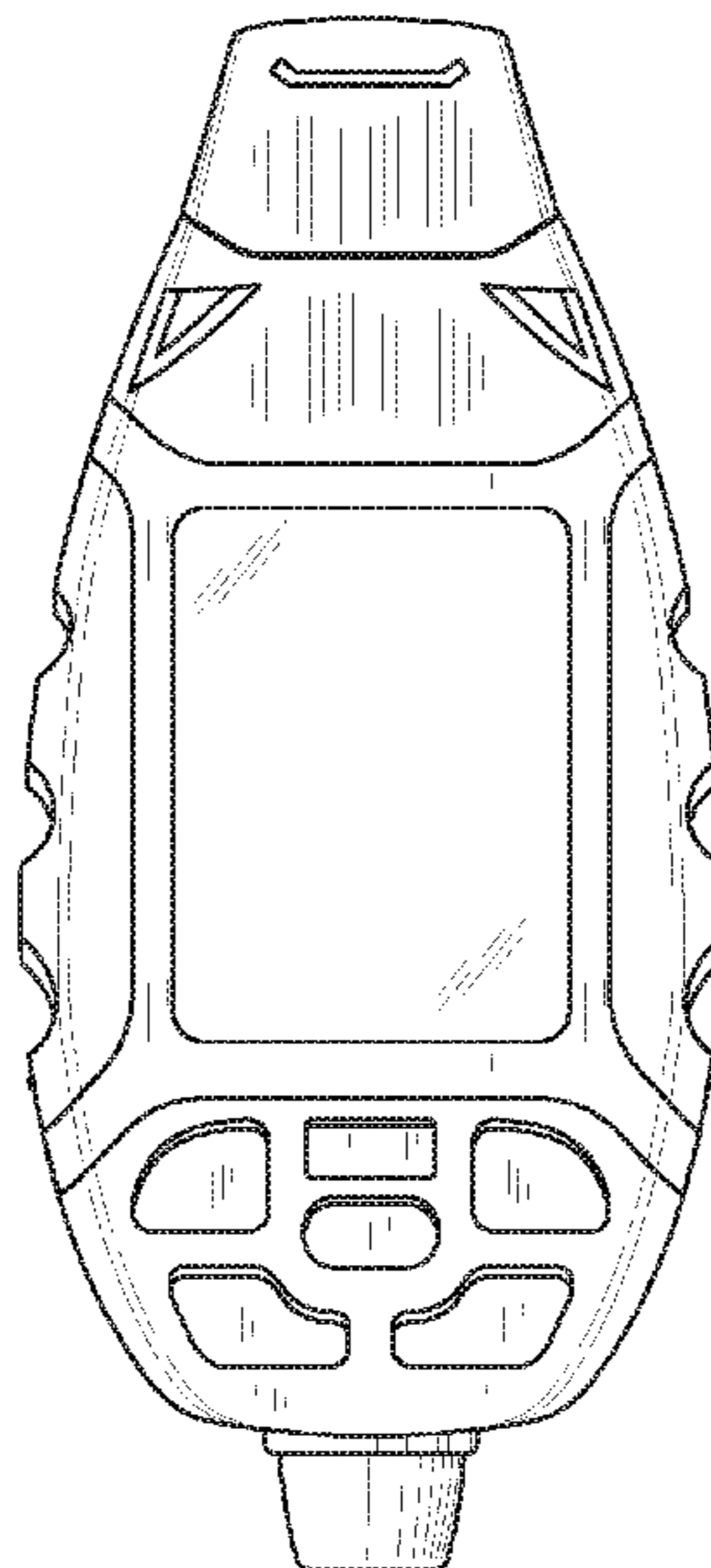
FIG. 4 is a top view thereof;

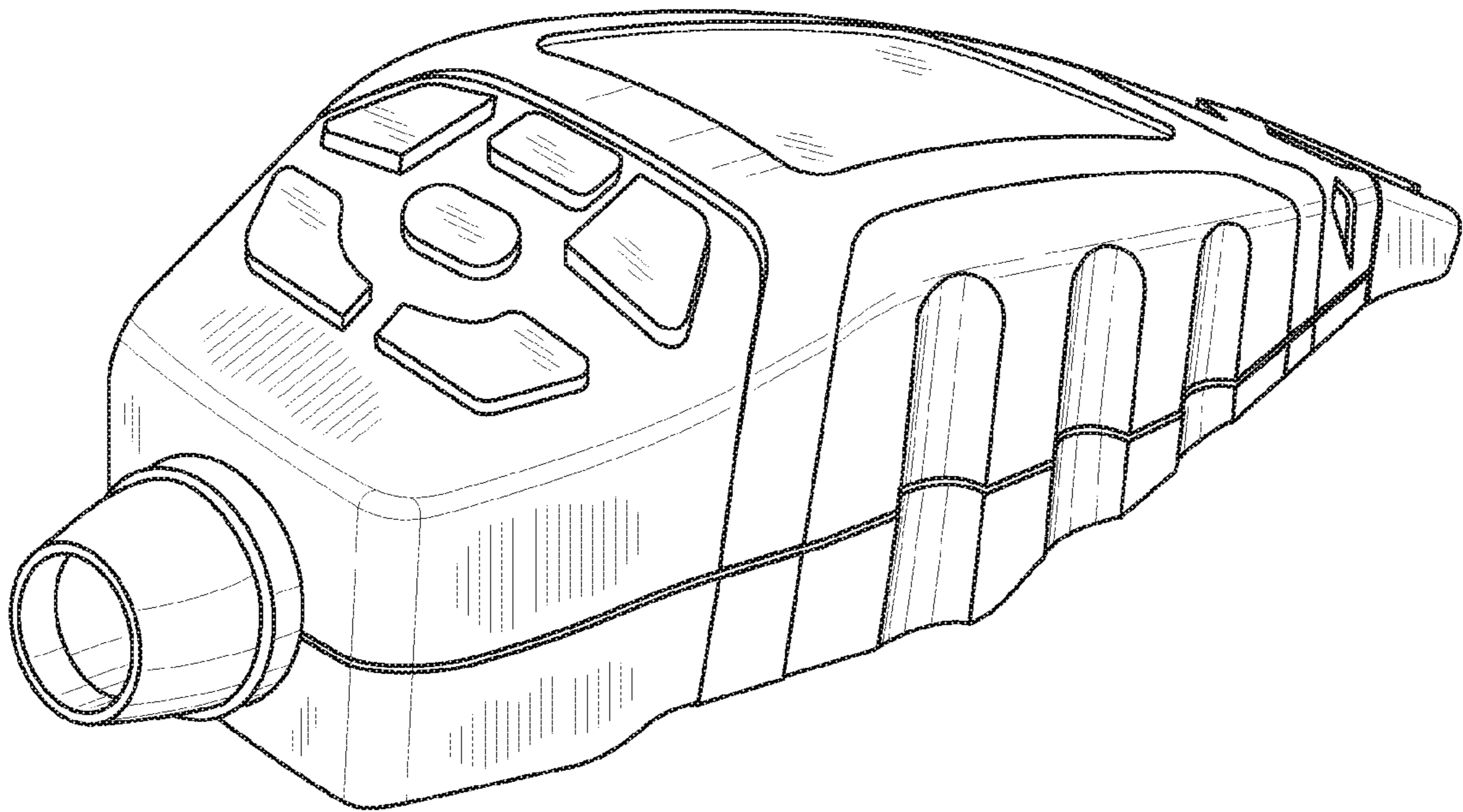
FIG. 5 is a bottom view thereof;

FIG. 6 is a front view thereof; and,

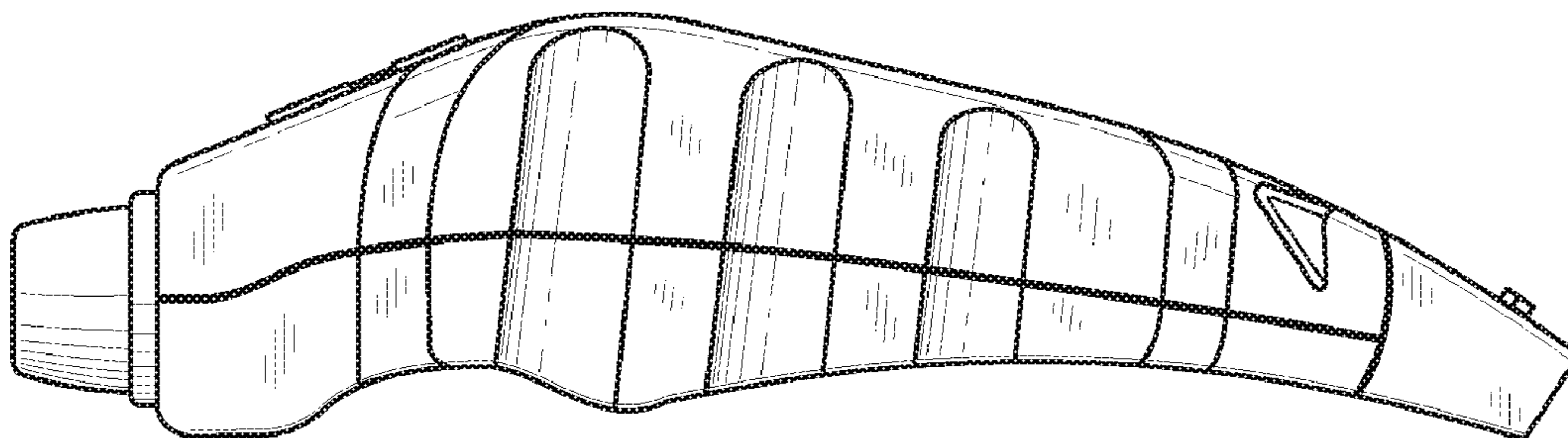
FIG. 7 is a back view thereof.

**1 Claim, 4 Drawing Sheets**

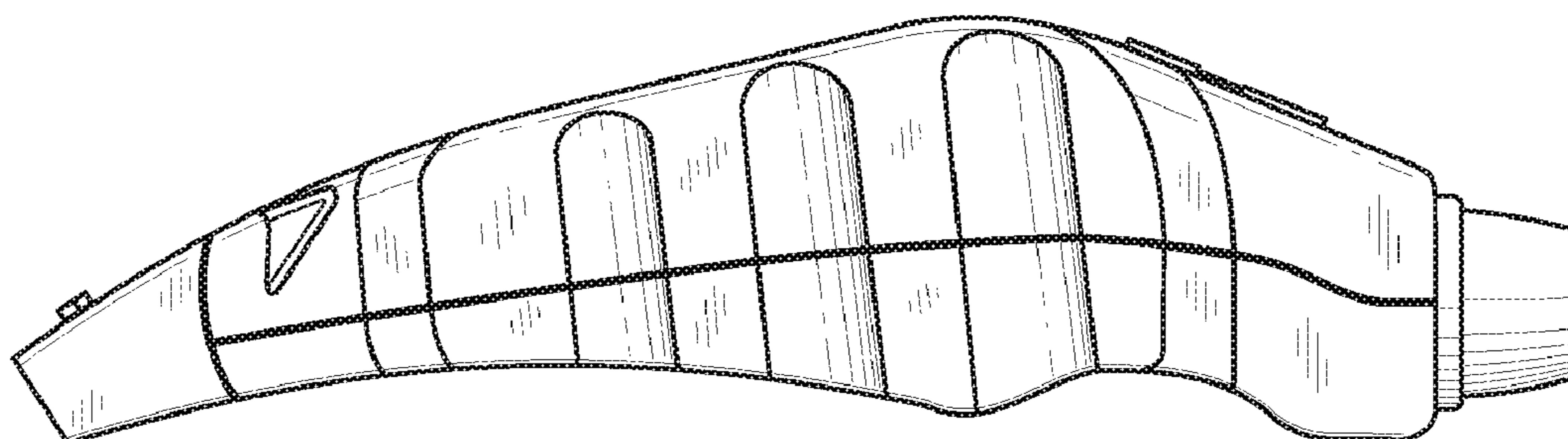




*FIG. 1*



*FIG. 2*



*FIG. 3*

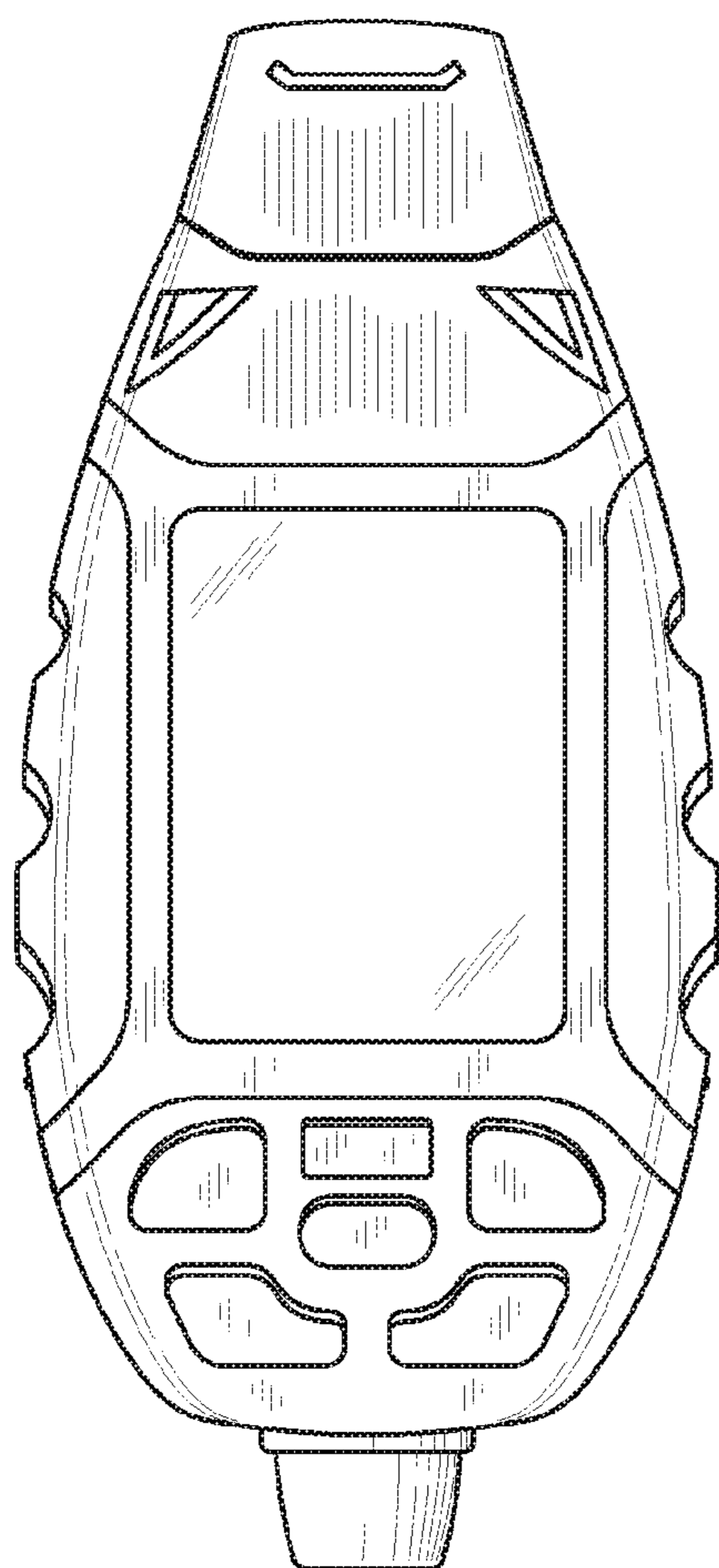


FIG. 4

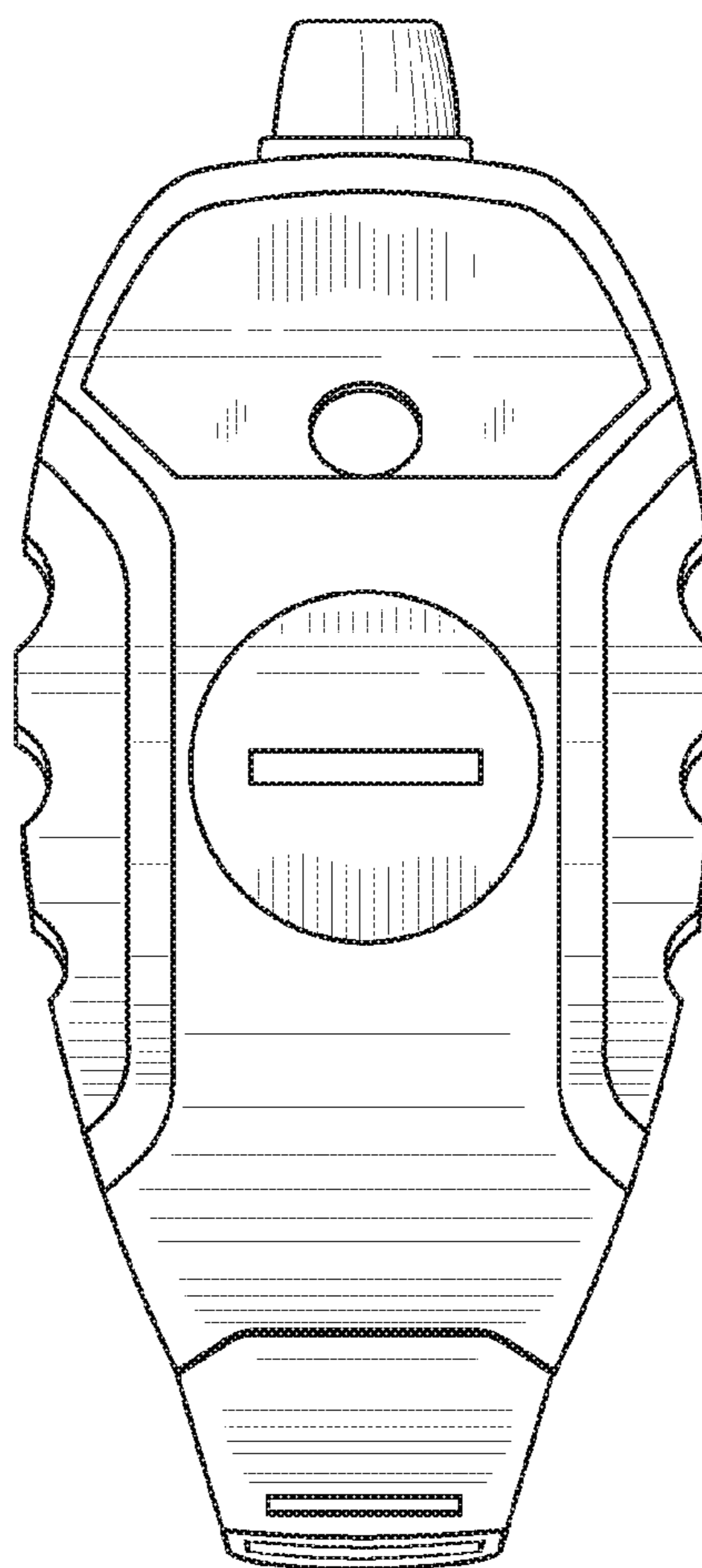
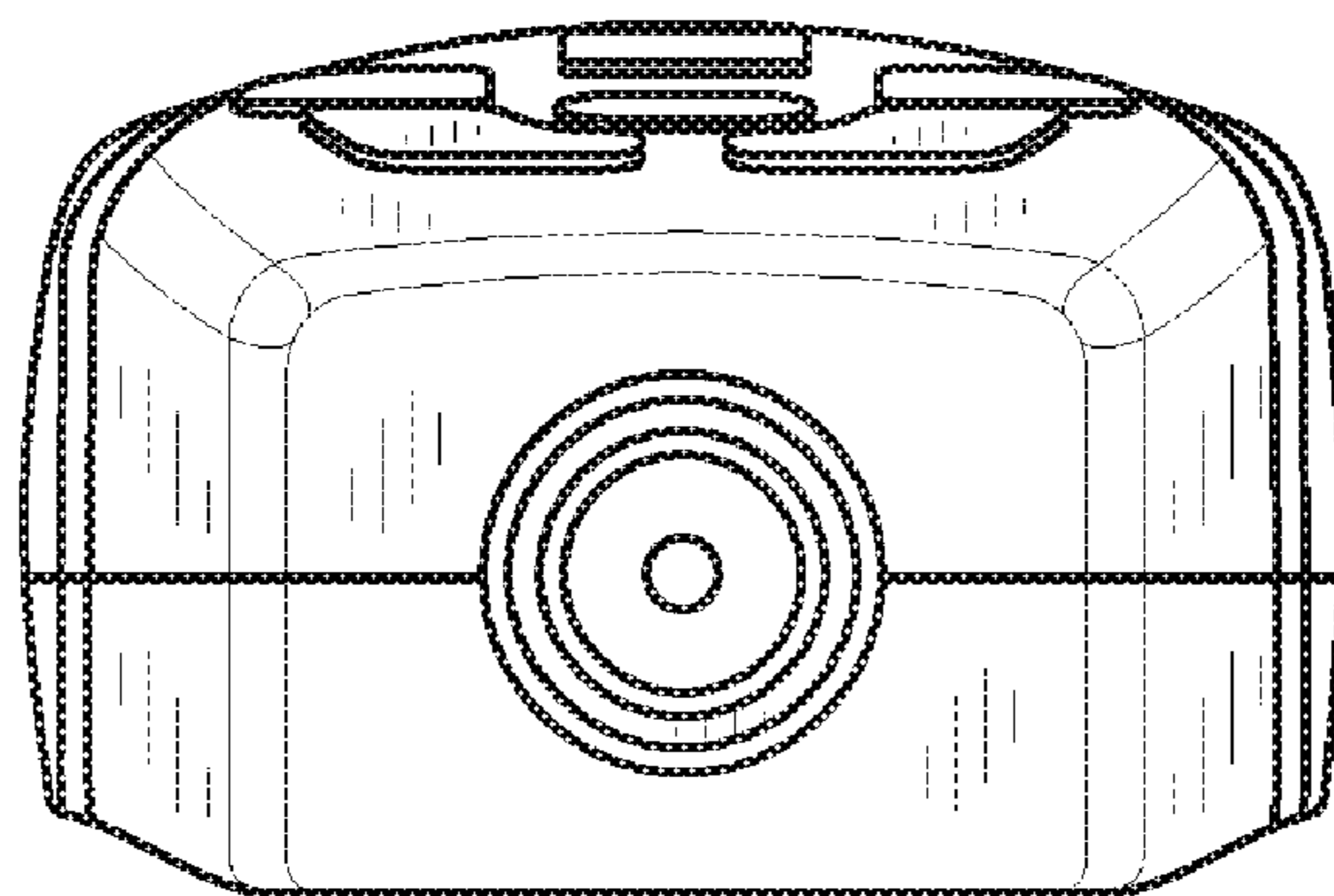
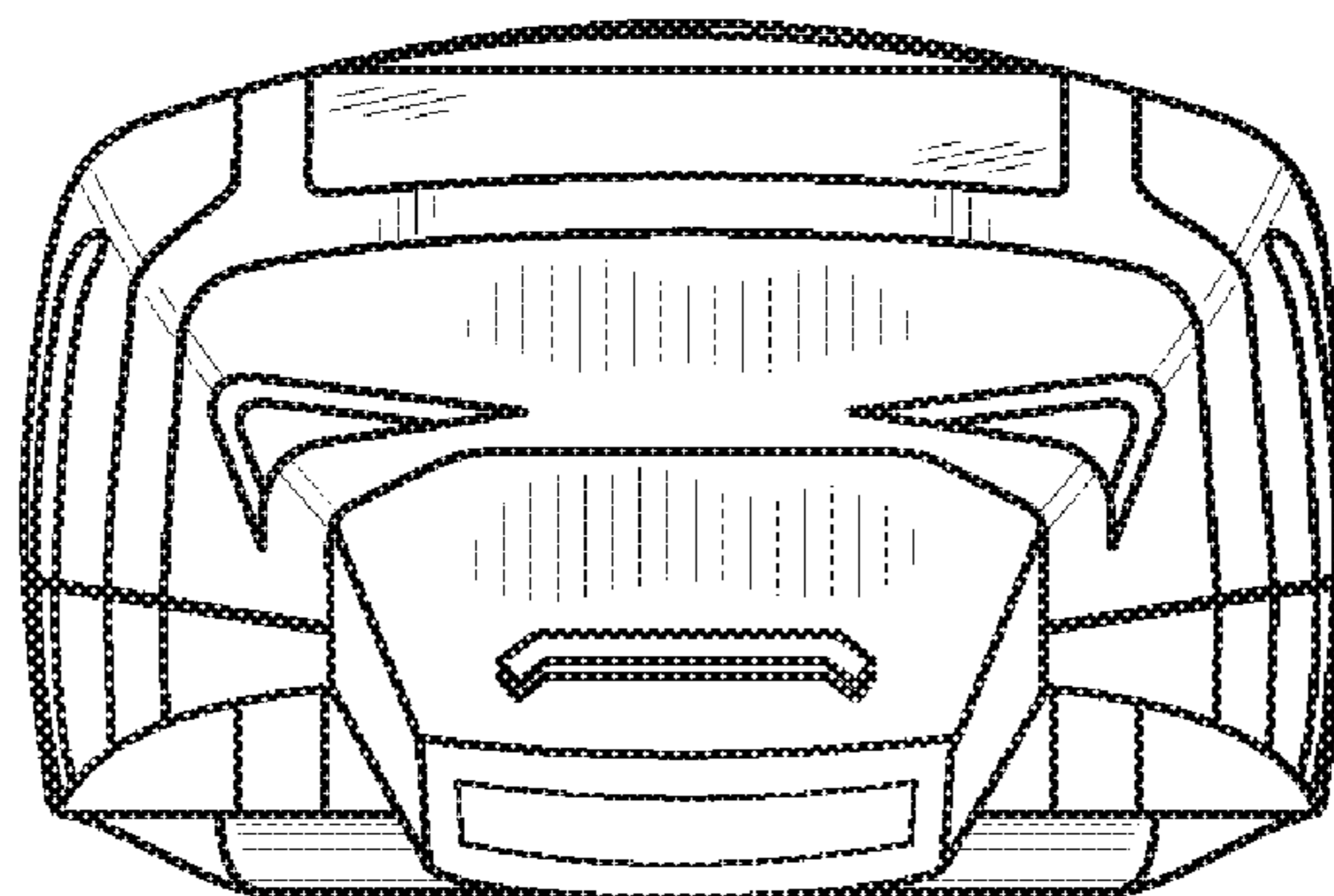


FIG. 5



*FIG. 6*



*FIG. 7*