



US00D623919S

(12) **United States Design Patent**
Chang

(10) **Patent No.:** **US D623,919 S**

(45) **Date of Patent:** **** Sep. 21, 2010**

(54) **TOOL HANDLE**

(76) Inventor: **Ming-Chi Chang**, 12F-4, No. 666, Sec. 2, Wuquan W. Rd., Nantun District, Taichung City (TW) 40878

(**) Term: **14 Years**

(21) Appl. No.: **29/345,014**

(22) Filed: **Oct. 8, 2009**

(51) **LOC (9) Cl.** **08-05**

(52) **U.S. Cl.** **D8/107**

(58) **Field of Classification Search** D8/82-87, D8/107, 300-303, 52-58; D7/394-395, D7/649; 81/177.1-177.7, 436, 439-440, 81/489, 417; 16/110.1, 421-422, 426-431
See application file for complete search history.

(56) **References Cited**

U.S. PATENT DOCUMENTS

- D432,381 S * 10/2000 Khachatoorian D8/80
- D456,576 S * 4/2002 Philipson D32/49
- D468,988 S * 1/2003 Goldmann et al. D8/107
- 6,513,198 B2 * 2/2003 Lu 16/431
- D483,634 S * 12/2003 Jansson et al. D8/52

- D494,040 S * 8/2004 Phillips D8/107
- D532,662 S * 11/2006 Chang D8/52
- D600,092 S * 9/2009 Peterson et al. D8/107
- 2009/0049960 A1 * 2/2009 Heinsohn 81/416

* cited by examiner

Primary Examiner—Cathron C Brooks

Assistant Examiner—Barbara Fox

(57) **CLAIM**

The ornamental design for a tool handle, as shown and described.

DESCRIPTION

FIG. 1 is a perspective view of a tool handle showing my new design;

FIG. 2 is a front elevational view thereof;

FIG. 3 is a rear elevational view thereof;

FIG. 4 is a left side view thereof;

FIG. 5 is a right side view thereof;

FIG. 6 is a top plan view thereof; and,

FIG. 7 is a bottom plan view thereof.

1 Claim, 6 Drawing Sheets

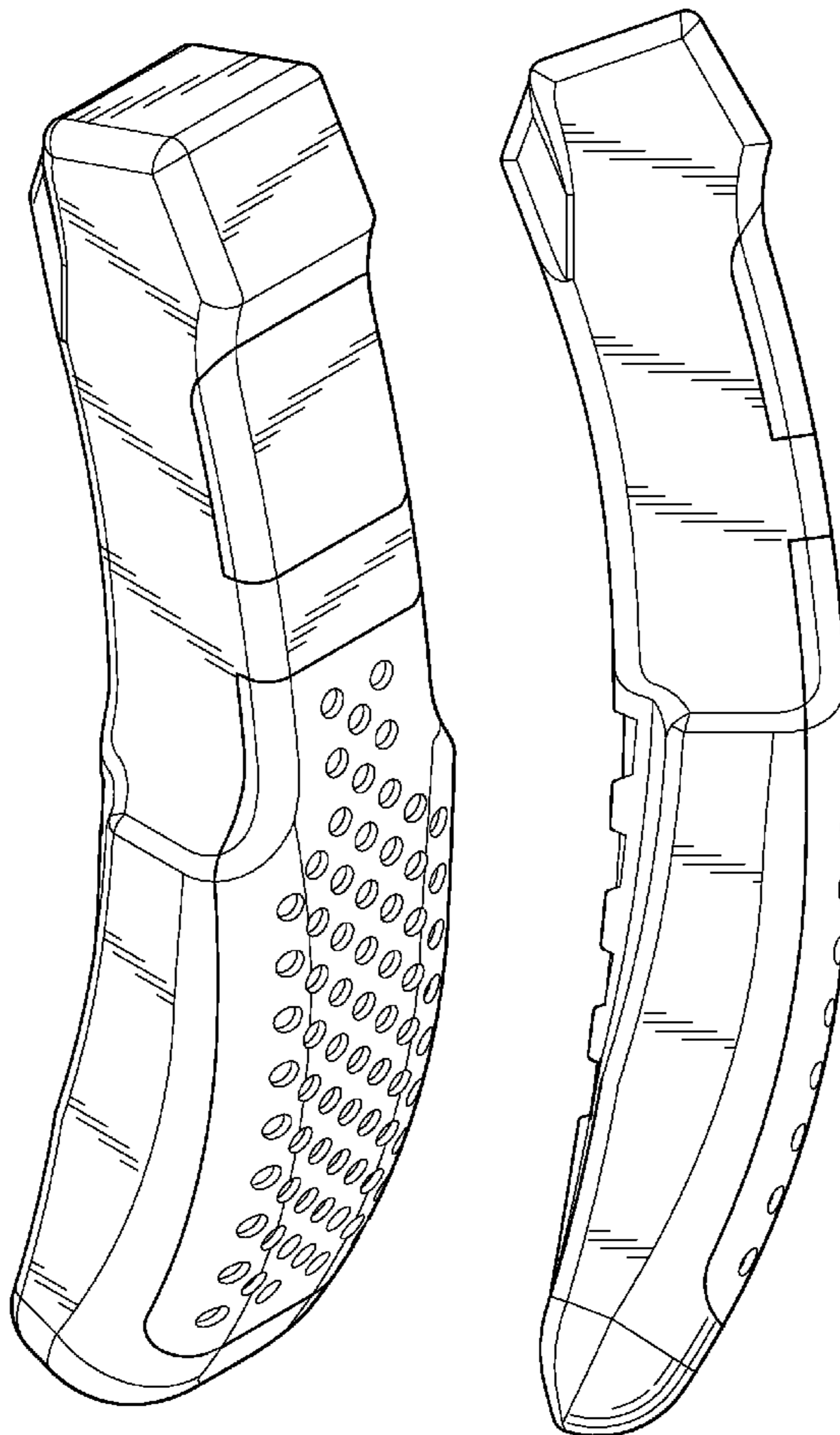

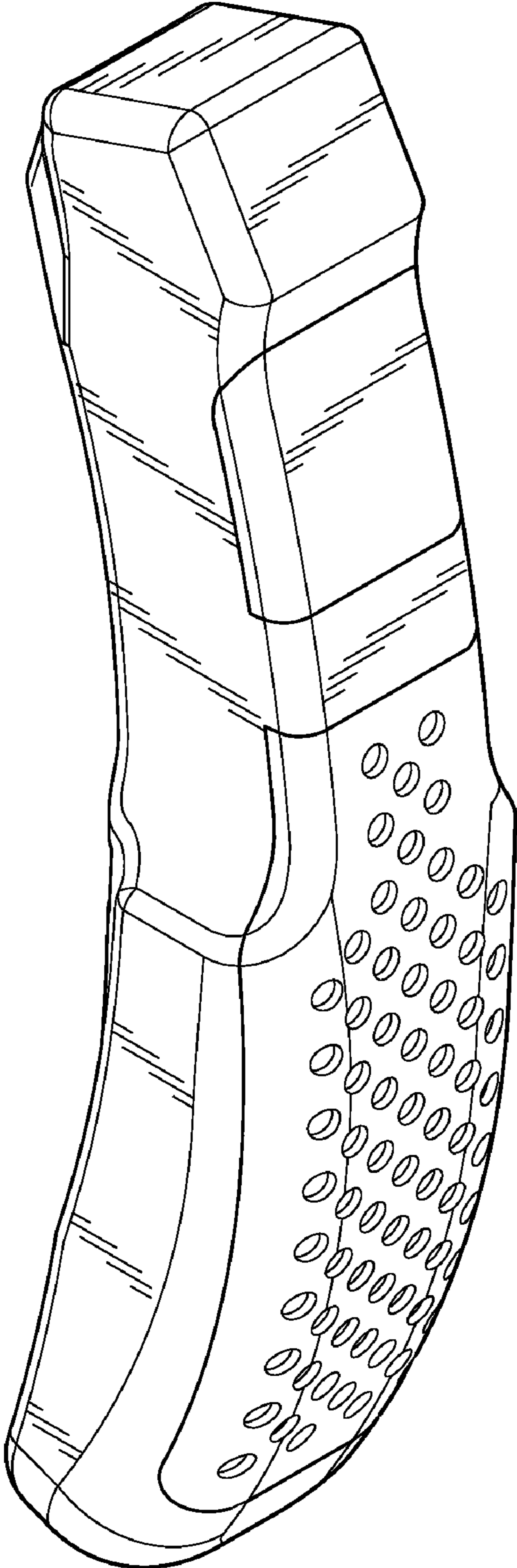

FIG. 1

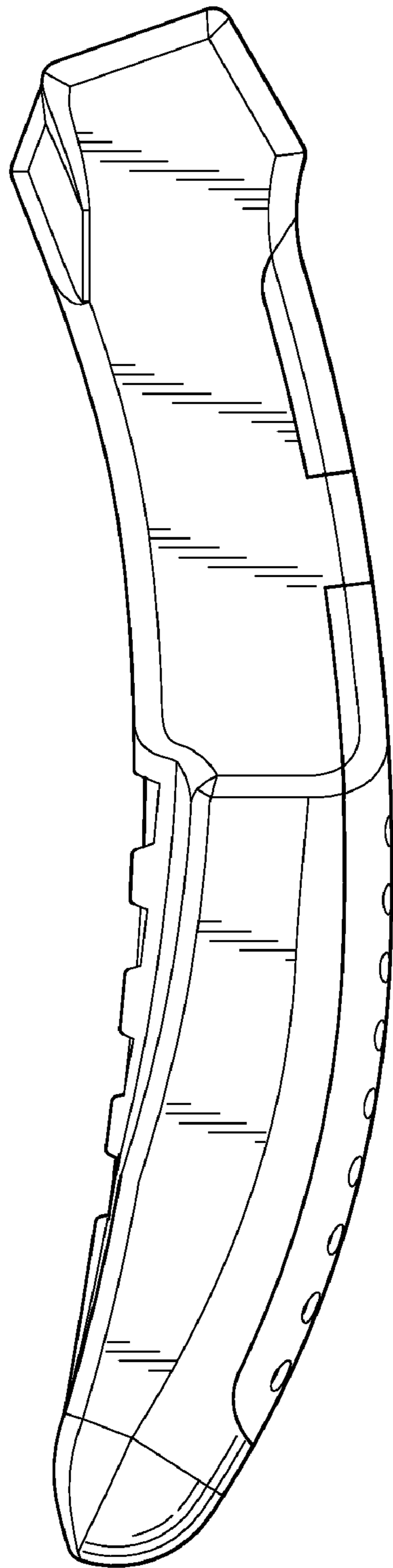

FIG. 2

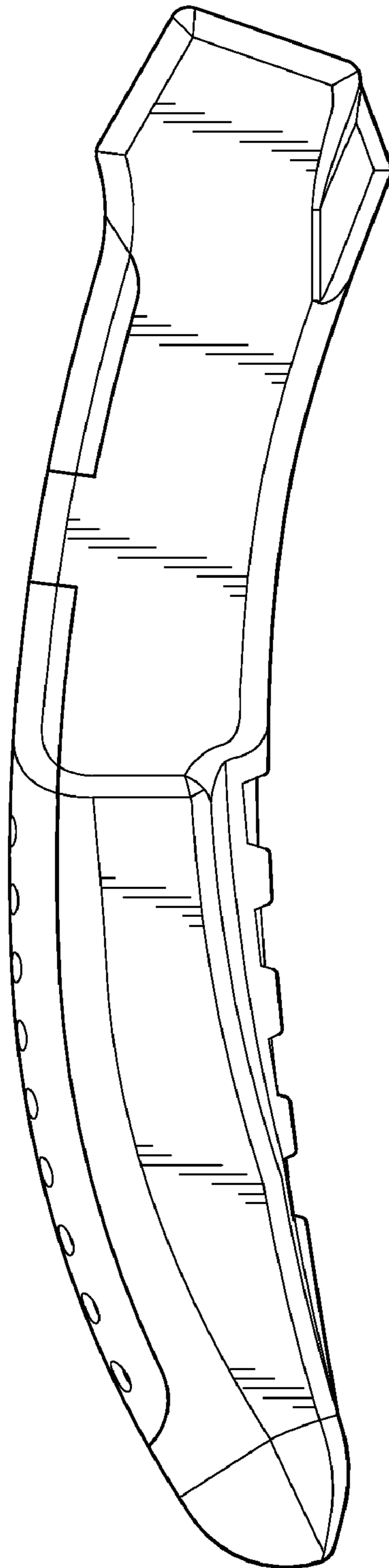

FIG. 3

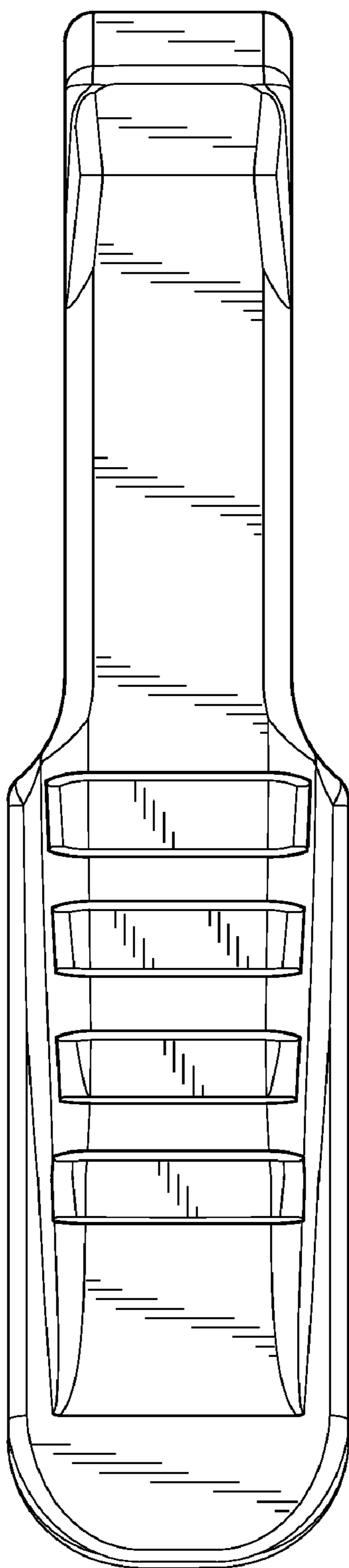

FIG. 4

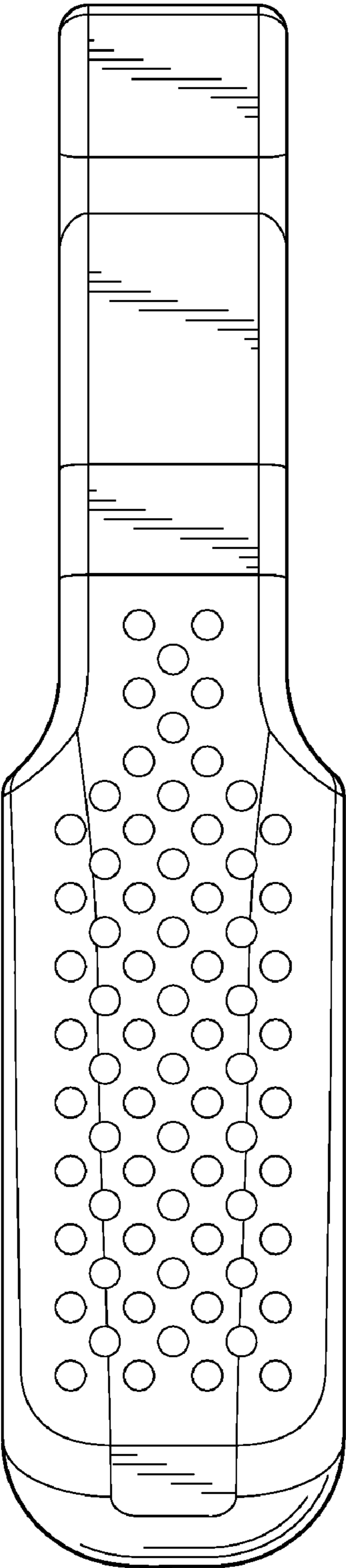

FIG. 5

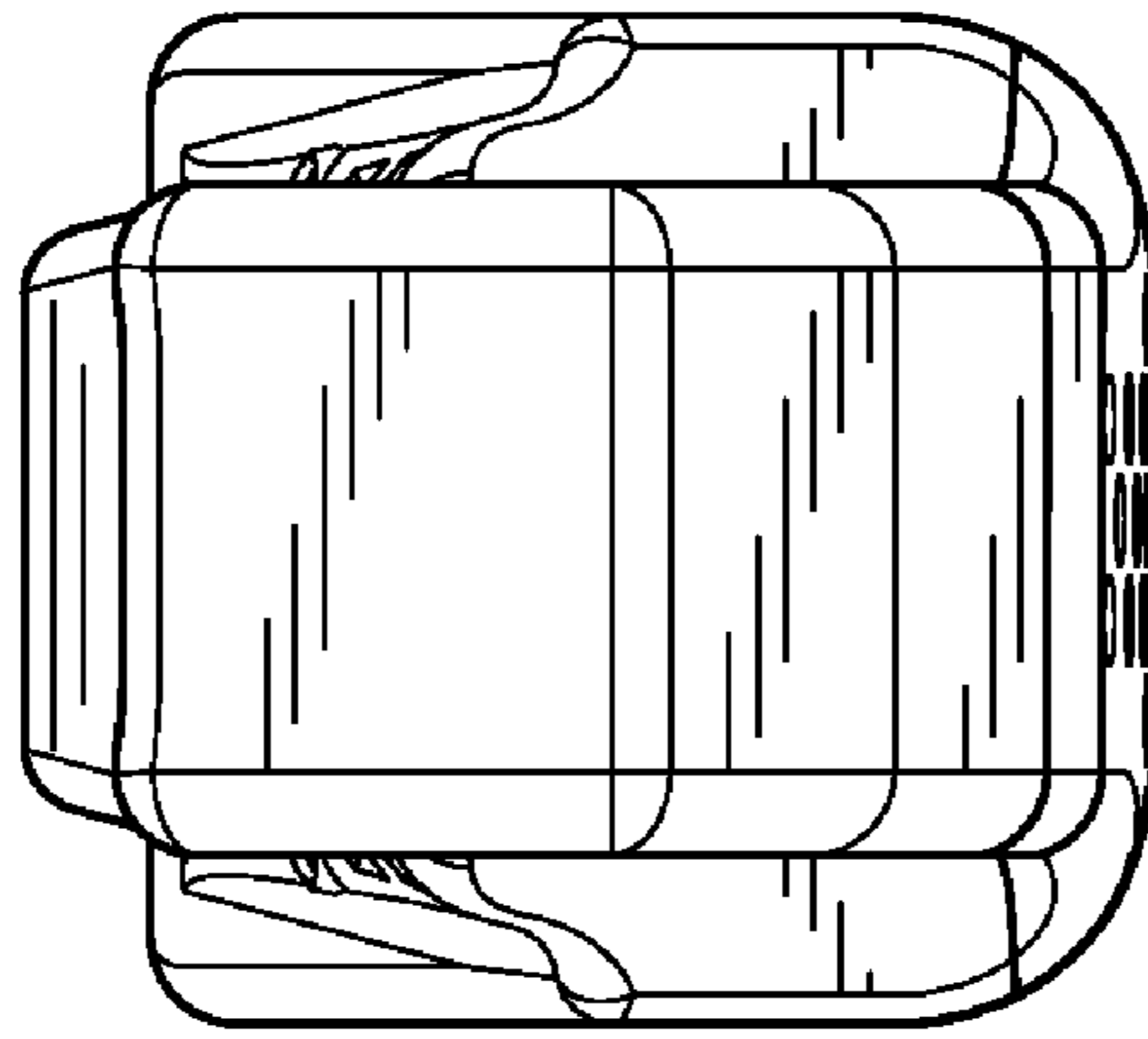

FIG. 6

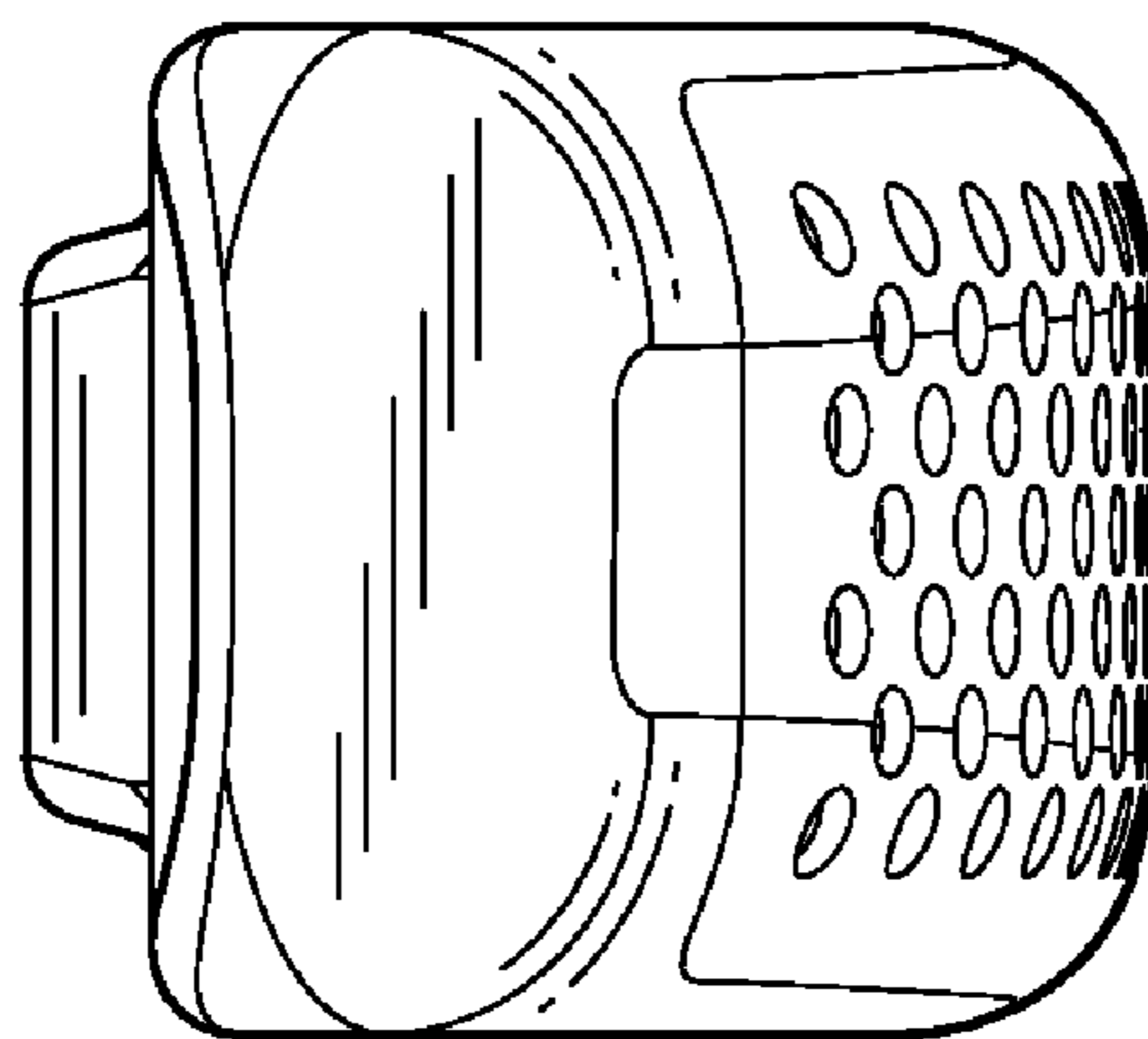

FIG. 7