



US00D623918S

(12) **United States Design Patent**
Arvinte et al.

(10) **Patent No.:** **US D623,918 S**

(45) **Date of Patent:** **** Sep. 21, 2010**

(54) **POLE HANDLE**

(75) Inventors: **Romeo Arvinte**, Laval-des-Rapides (CA); **Francois Panfili**, Berthierville (CA)

(73) Assignee: **A. Richard Tools Co./Outils A. Richard Co.**, Berthierville (Quebec) (CA)

(**) Term: **14 Years**

(21) Appl. No.: **29/341,092**

(22) Filed: **Jul. 30, 2009**

(30) **Foreign Application Priority Data**

Mar. 25, 2009 (CA) 130088

(51) **LOC (9) Cl.** **08-05**

(52) **U.S. Cl.** **D8/107**

(58) **Field of Classification Search** D8/47, D8/107, 303; D7/393, 395, 645; D32/40, D32/41, 46, 49, 52; 30/169, 340, 166 R; 16/110.1, 421, 422; 81/177.1–177.7, 489
See application file for complete search history.

(56) **References Cited**

U.S. PATENT DOCUMENTS

D130,814 S * 12/1941 Comiskey D8/303
D132,891 S * 6/1942 Chapman D8/25
D300,602 S * 4/1989 Smith, Sr. D8/303
D404,281 S * 1/1999 Milbury D8/107
6,568,299 B2 * 5/2003 Hu 81/63.2
D481,290 S * 10/2003 Thompson et al. D8/107

D493,341 S * 7/2004 Chen D8/25
D518,692 S * 4/2006 Saunders D8/25

* cited by examiner

Primary Examiner—Cathron C Brooks

Assistant Examiner—Barbara Fox

(74) *Attorney, Agent, or Firm*—Fish & Richardson P.C.

(57) **CLAIM**

The ornamental design for a pole handle, as shown and described.

DESCRIPTION

FIG. 1 is a perspective view of a pole handle showing our new design.

FIG. 2 is a front elevational view thereof.

FIG. 3 is a rear elevational view thereof.

FIG. 4 is a top plan view thereof.

FIG. 5 is a bottom plan view thereof.

FIG. 6 is a left elevational side view thereof.

FIG. 7 is a right elevational side view thereof.

FIG. 8 is a perspective view of a pole handle showing a variant of our new design.

FIG. 9 is a front elevational view thereof.

FIG. 10 is a rear elevational view thereof.

FIG. 11 is a top plan view thereof.

FIG. 12 is a bottom plan view thereof.

FIG. 13 is a left elevational side view thereof; and,

FIG. 14 is a right elevational side view thereof.

1 Claim, 14 Drawing Sheets

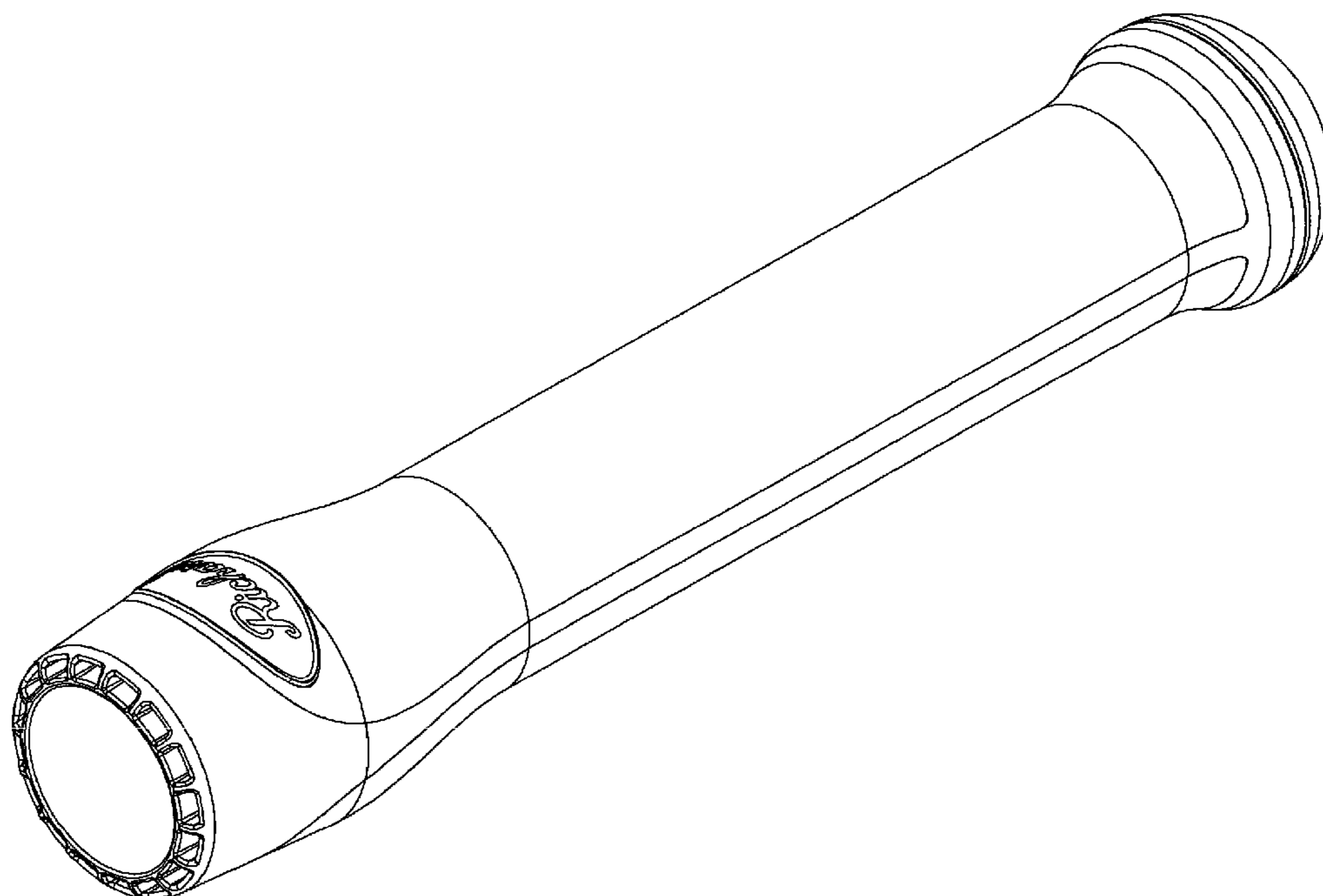

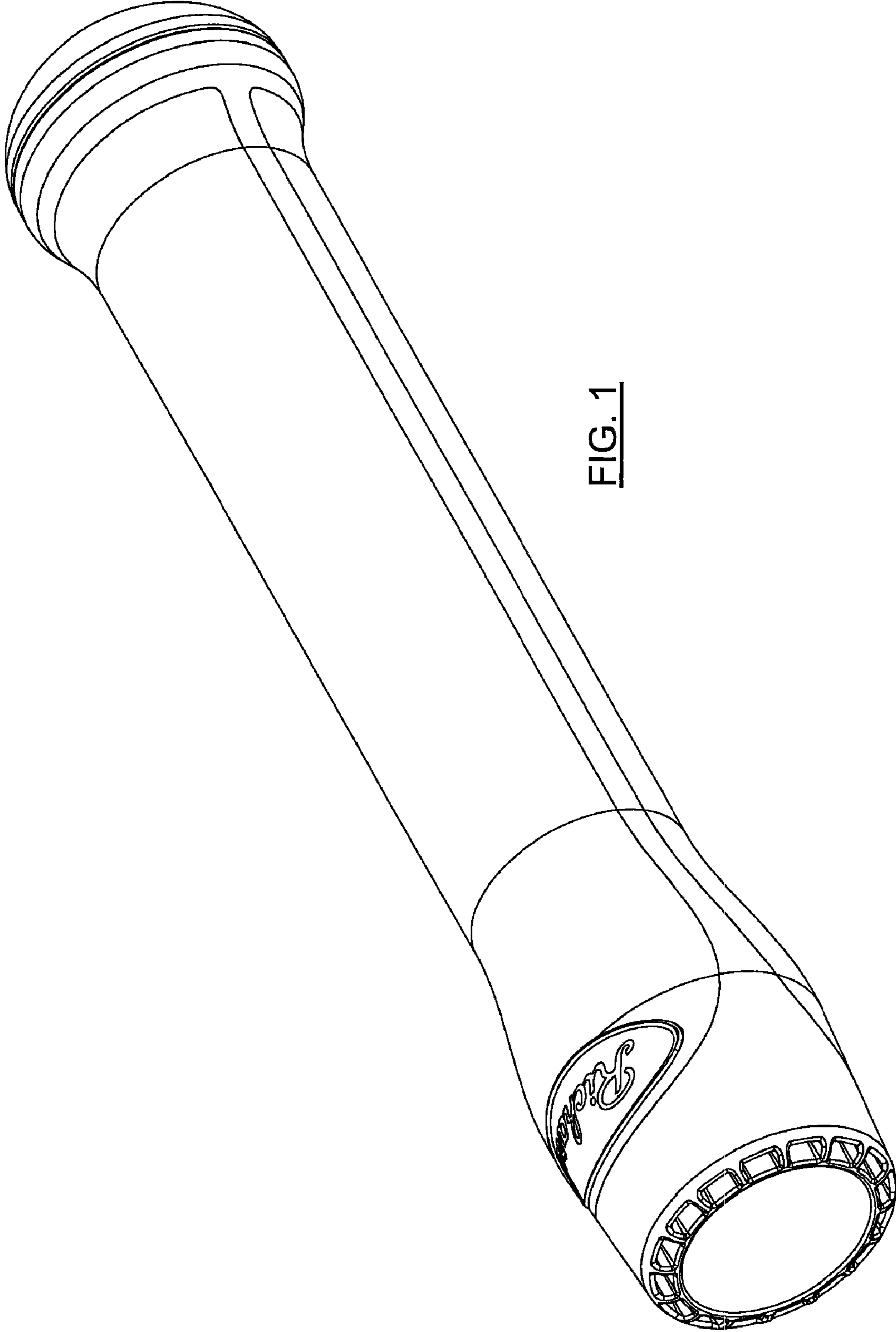

FIG. 1

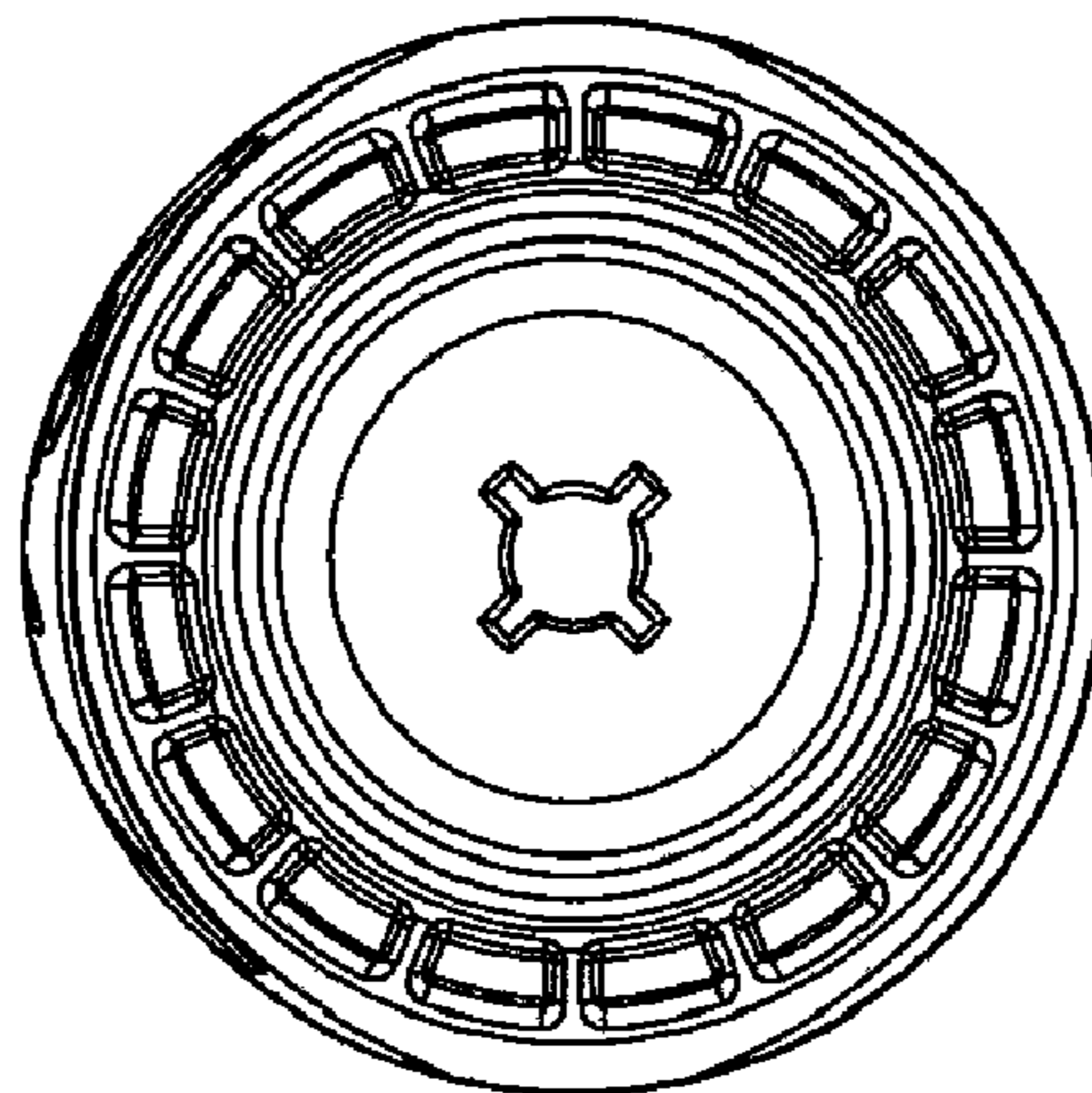

FIG. 2

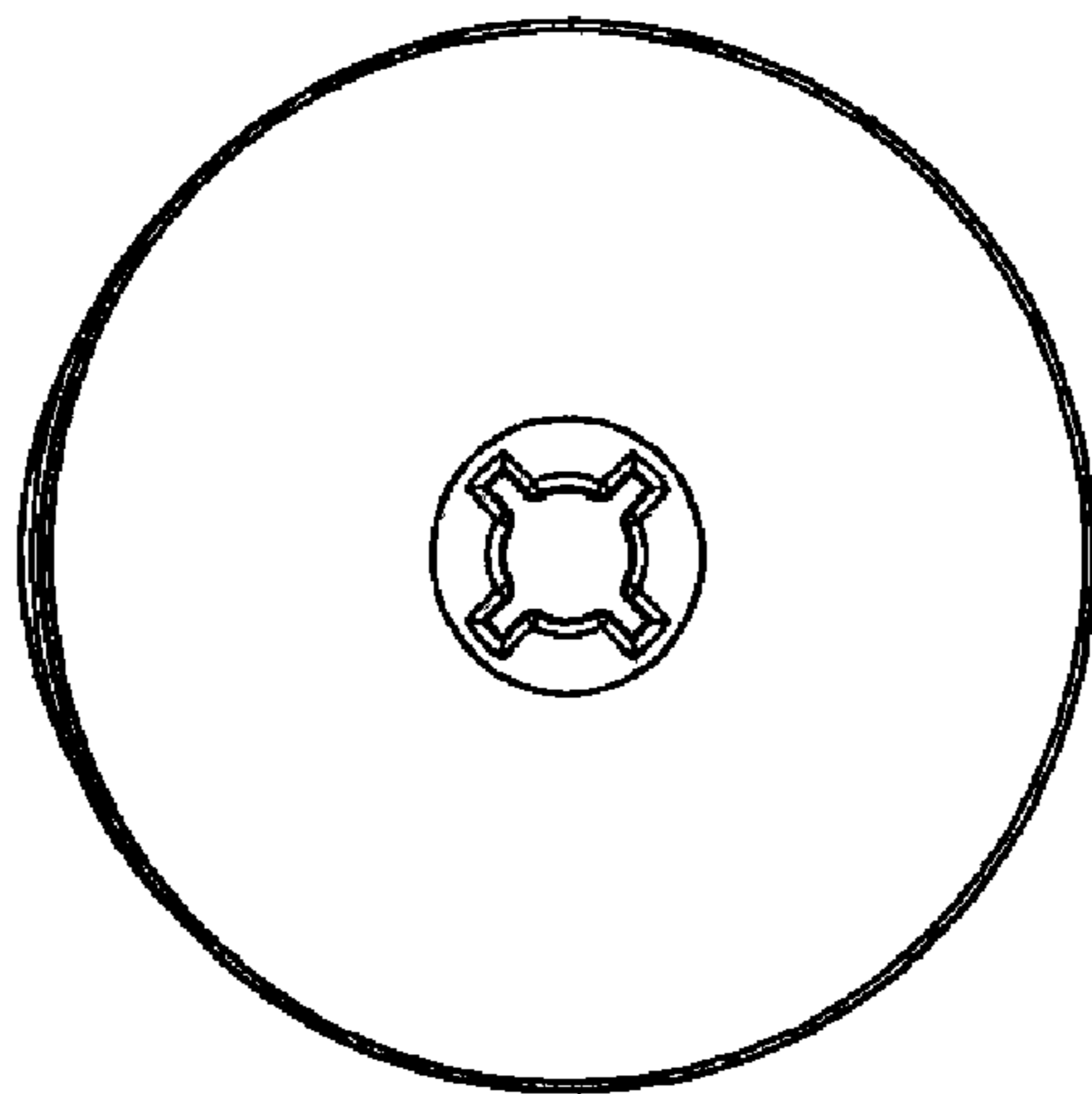

FIG. 3

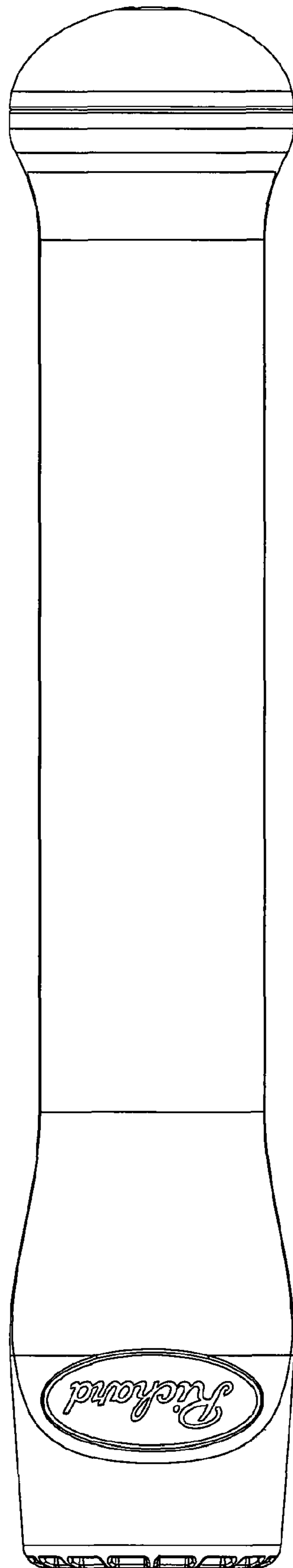

FIG. 4

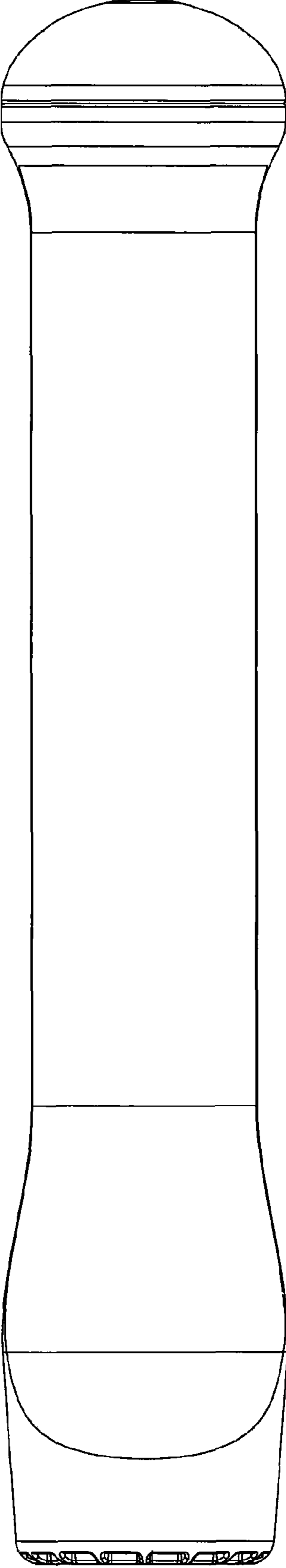

FIG. 5

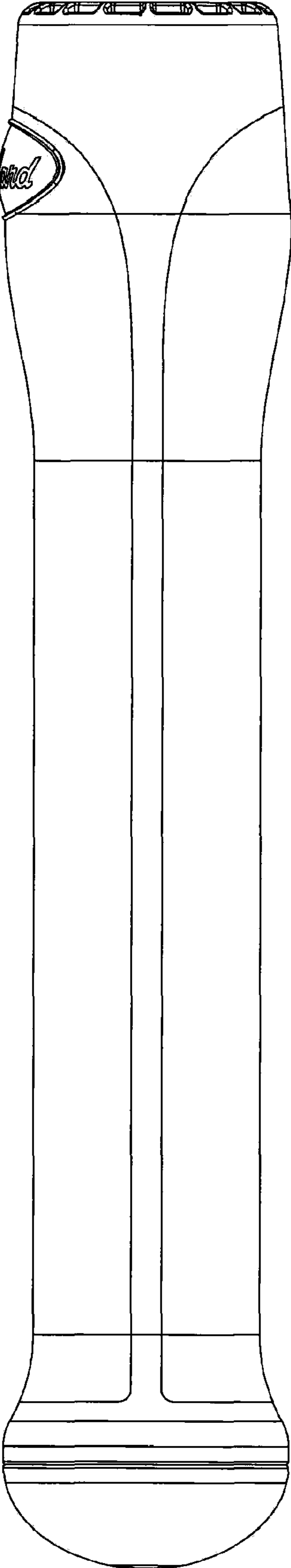

FIG. 6

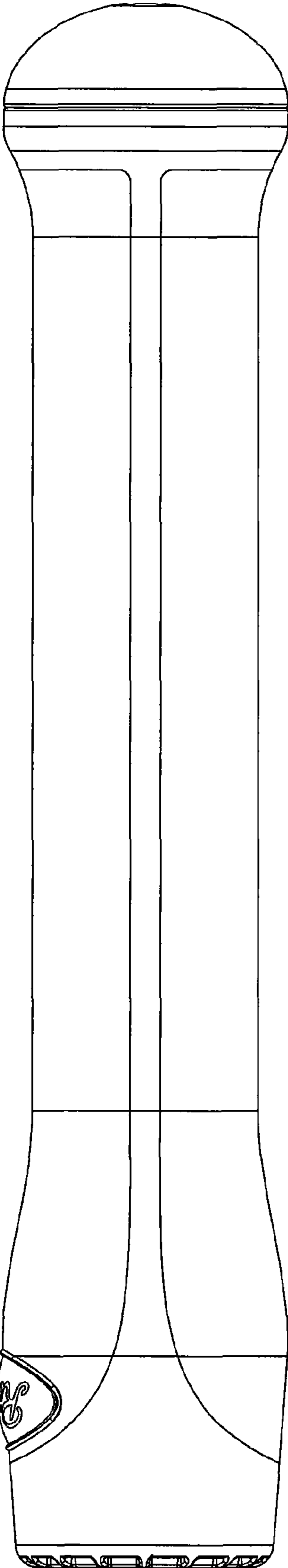

FIG. 7

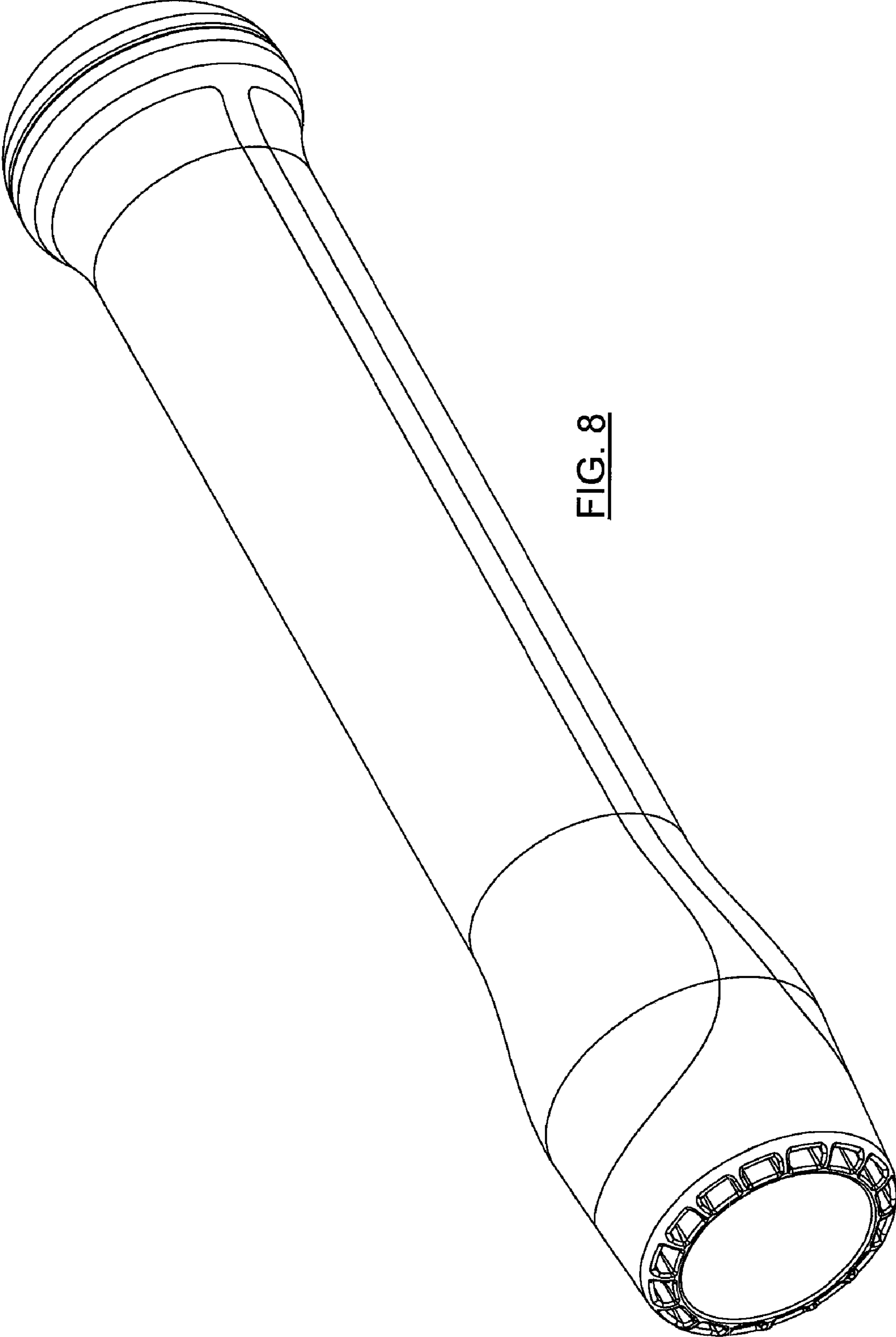

FIG. 8

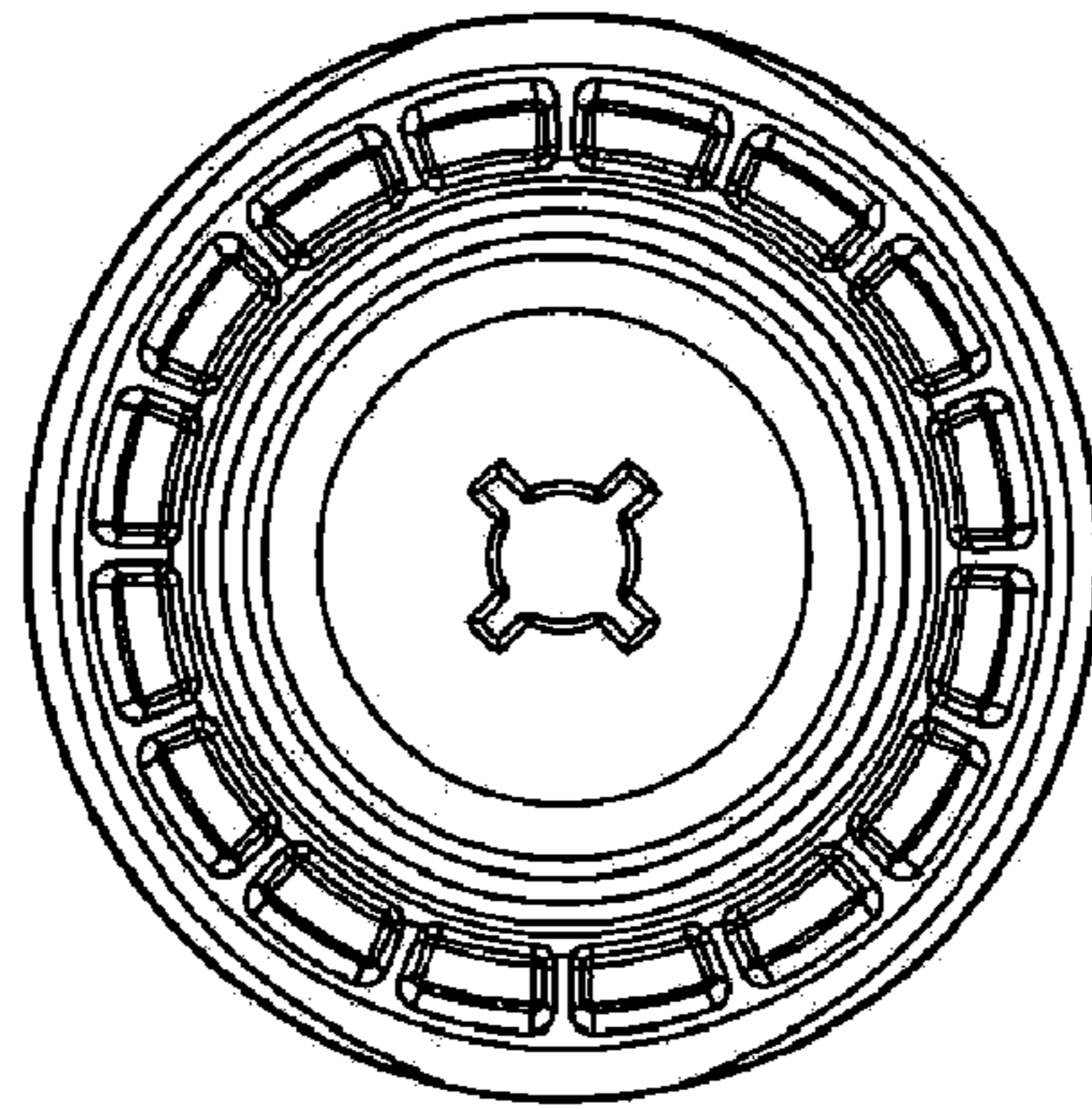

FIG. 9

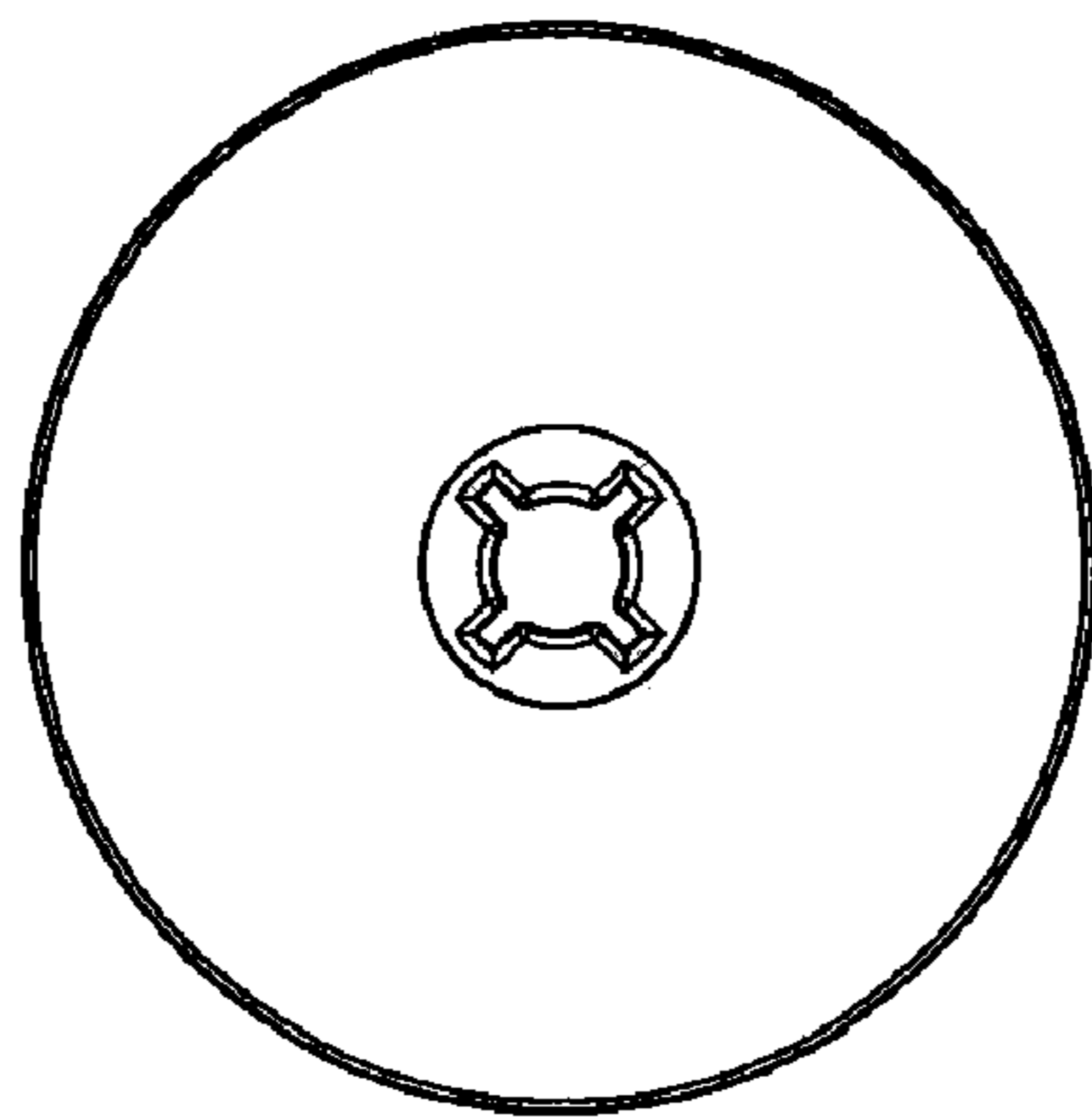

FIG. 10

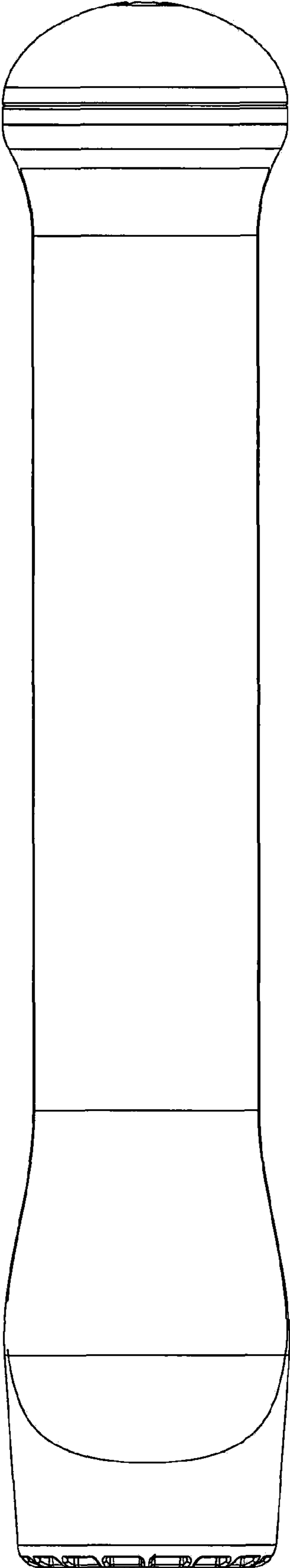

FIG. 11

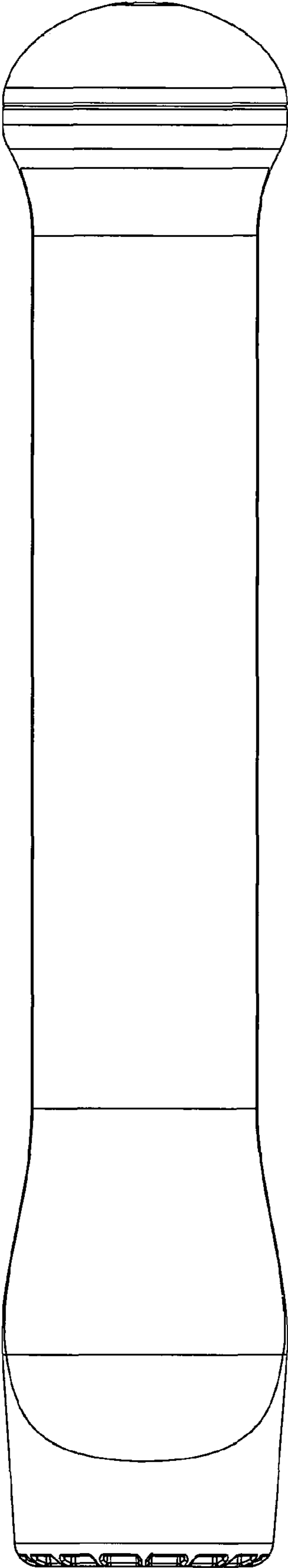

FIG. 12

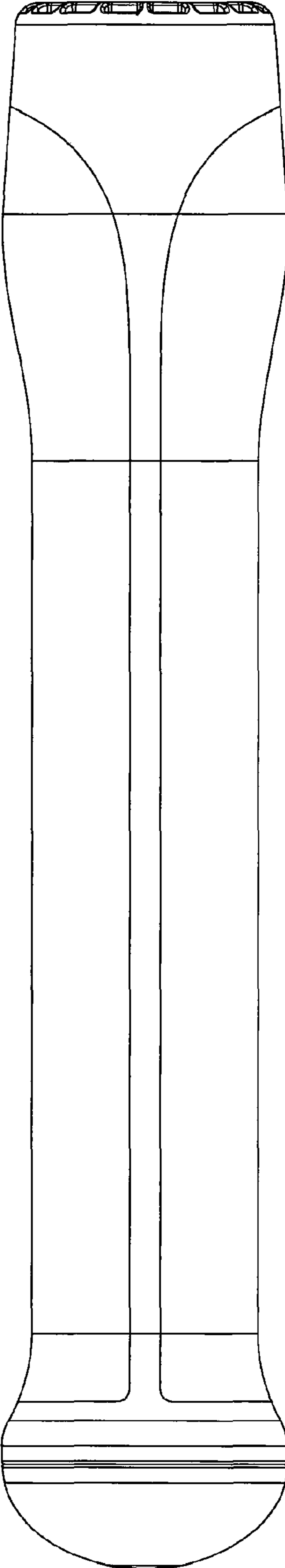

FIG. 13

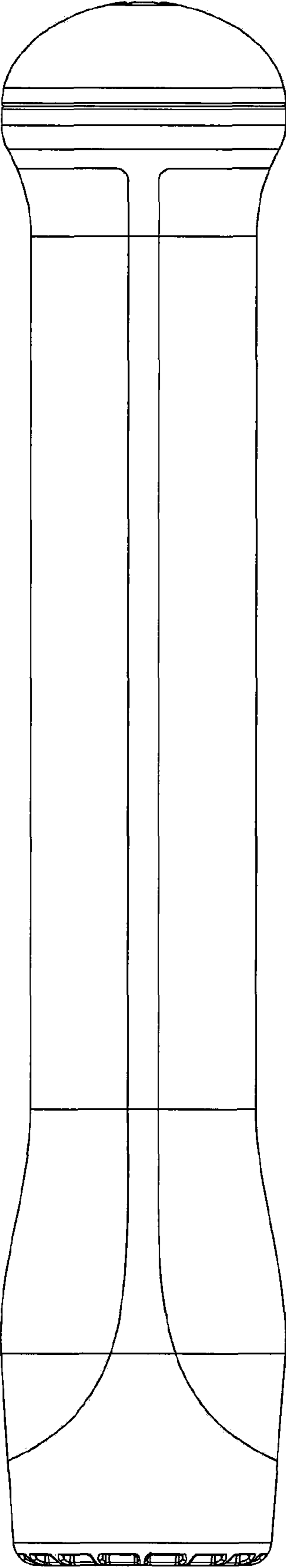

FIG. 14