



US00D623917S

(12) **United States Design Patent**
Goetz et al.

(10) **Patent No.:** **US D623,917 S**
(45) **Date of Patent:** **** Sep. 21, 2010**

(54) **SCISSORS**

(75) Inventors: **Michael H. Goetz**, Berlin, PA (US);
David W. Miller, Fairhope, PA (US)

(73) Assignee: **Gilmour, Inc.**, Newark, DE (US)

(**) Term: **14 Years**

(21) Appl. No.: **29/345,944**

(22) Filed: **Oct. 23, 2009**

(51) **LOC (9) Cl.** **08-07**

(52) **U.S. Cl.** **D8/57**

(58) **Field of Classification Search** D8/4,
D8/5, 51-58, 105, 107; D21/532; D27/195;
D28/44, 57; 30/131, 195, 229, 194, 230-235,
30/268, 350, 254-258; 7/135, 136
See application file for complete search history.

(56) **References Cited**

U.S. PATENT DOCUMENTS

2,528,326	A *	10/1950	Vosbikian et al.	30/260
D307,696	S	5/1990	Ishida et al.	
5,063,671	A *	11/1991	Huang	30/262
5,377,412	A *	1/1995	Schofield et al.	30/262
D434,285	S	11/2000	Podlesny	
D450,553	S *	11/2001	Chien	D8/57
D450,987	S *	11/2001	Chien	D8/57
D460,333	S *	7/2002	Carpenter et al.	D8/57
D469,323	S *	1/2003	Linden	D8/5
6,643,937	B1 *	11/2003	Wu	30/262
D483,239	S *	12/2003	Sprouse	D8/57
D491,775	S *	6/2004	Tomchak et al.	D8/5
D496,837	S	10/2004	Tomchak et al.	
D501,378	S	2/2005	Tatic	
D503,324	S	3/2005	Carlson et al.	
D506,906	S	7/2005	Wu	
RE39,286	E *	9/2006	Silver et al.	30/134
D536,940	S	2/2007	Peterson et al.	
D537,311	S *	2/2007	Peterson et al.	D8/57
D545,646	S	7/2007	Shan	
D547,139	S	7/2007	Shan	

D547,140	S	7/2007	Shan	
D557,094	S *	12/2007	Raia et al.	D8/53
D578,841	S	10/2008	Huang	
D580,236	S *	11/2008	Wu	D8/5
D584,122	S	1/2009	Caroca	
D595,548	S	7/2009	Lipscomb et al.	
D607,702	S	1/2010	Wu	
2003/0159292	A1 *	8/2003	Wu	30/123.3
2007/0144015	A1 *	6/2007	Peterson et al.	30/262
2008/0301951	A1 *	12/2008	Lai	30/254
2010/0107421	A1 *	5/2010	Cedar et al.	30/232

* cited by examiner

Primary Examiner—Stella M Reid

Assistant Examiner—Deanna Fluegeman

(74) *Attorney, Agent, or Firm*—Maginot, Moore & Beck

(57) **CLAIM**

The ornamental design for scissors, as shown and described.

DESCRIPTION

FIG. 1 is a perspective view of scissors showing our new design;

FIG. 2 is a left side elevational view showing the design for the scissors of FIG. 1;

FIG. 3 is a right side elevational view showing the design for the scissors of FIG. 1;

FIG. 4 is a front elevational view showing the design for the scissors of FIG. 1;

FIG. 5 is a rear elevational view showing the design for the scissors of FIG. 1;

FIG. 6 is a top elevational view showing the design for the scissors of FIG. 1; and,

FIG. 7 is a bottom elevational view showing the design for the scissors of FIG. 1.

The broken line showing of portions of the scissors is included for illustrative purposes only and forms no part of the claimed design.

1 Claim, 4 Drawing Sheets

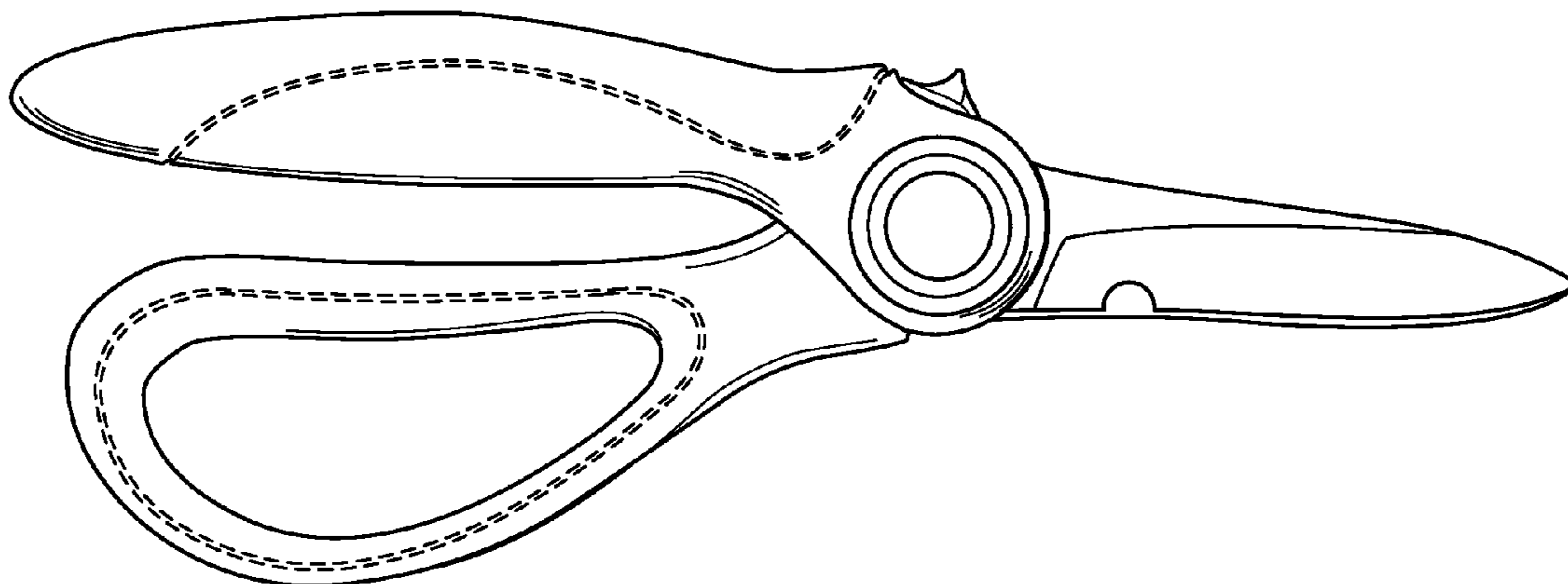

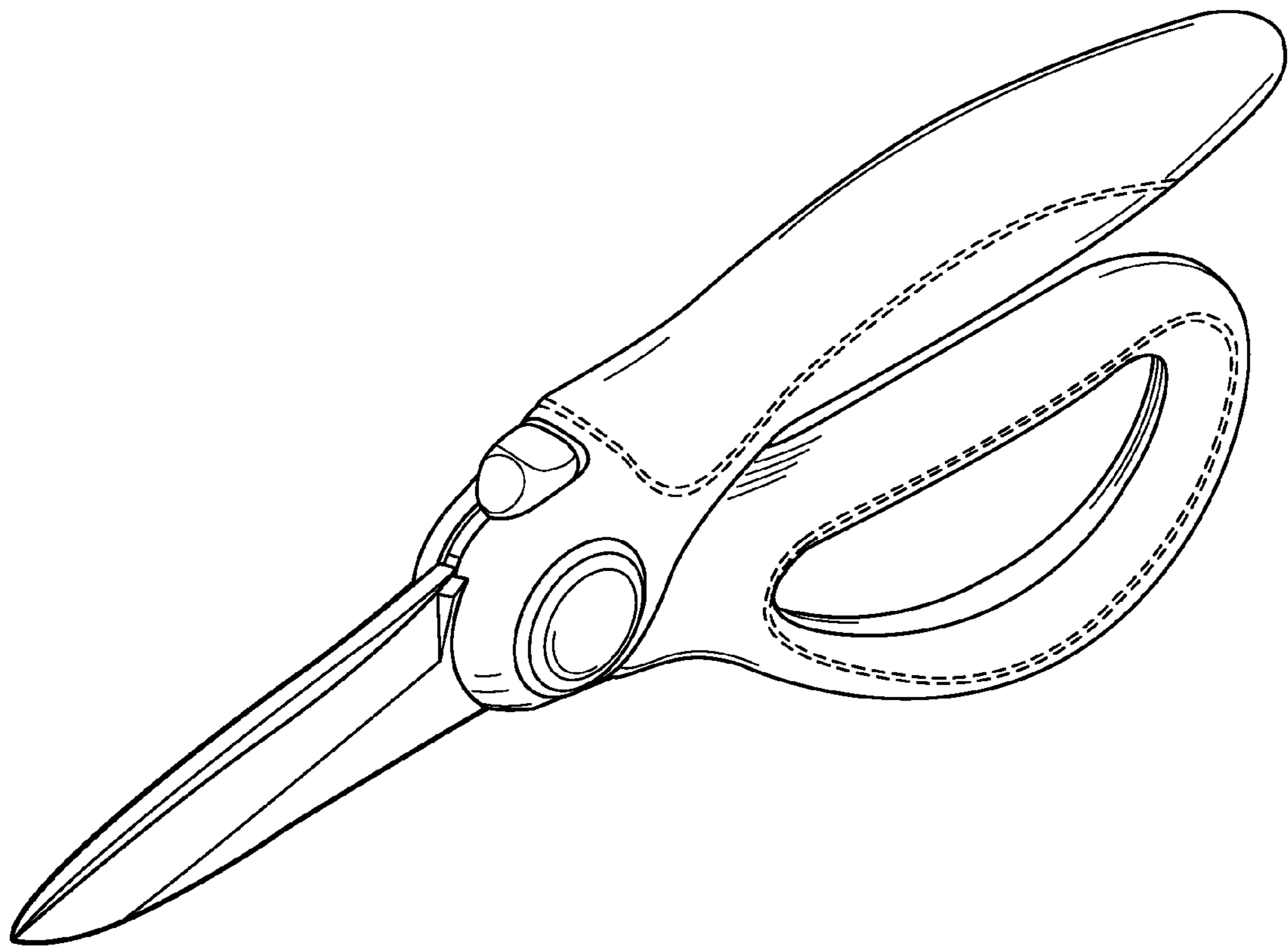

FIG. 1

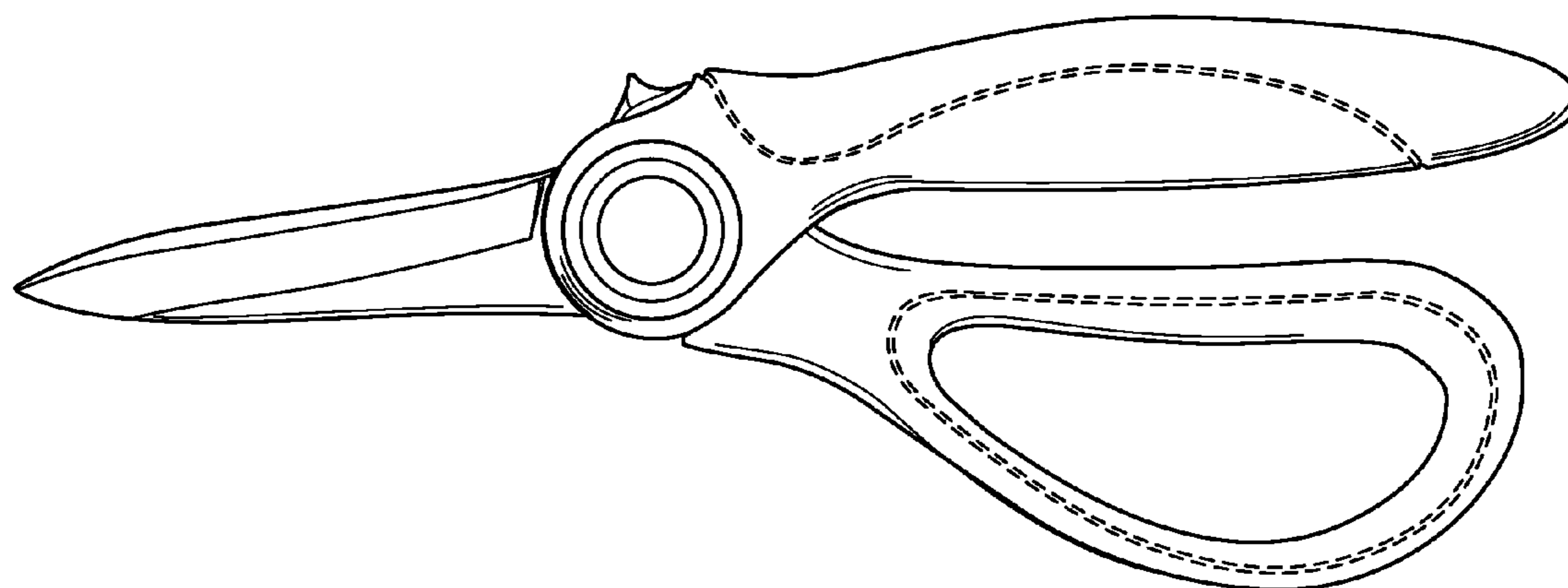

FIG. 2

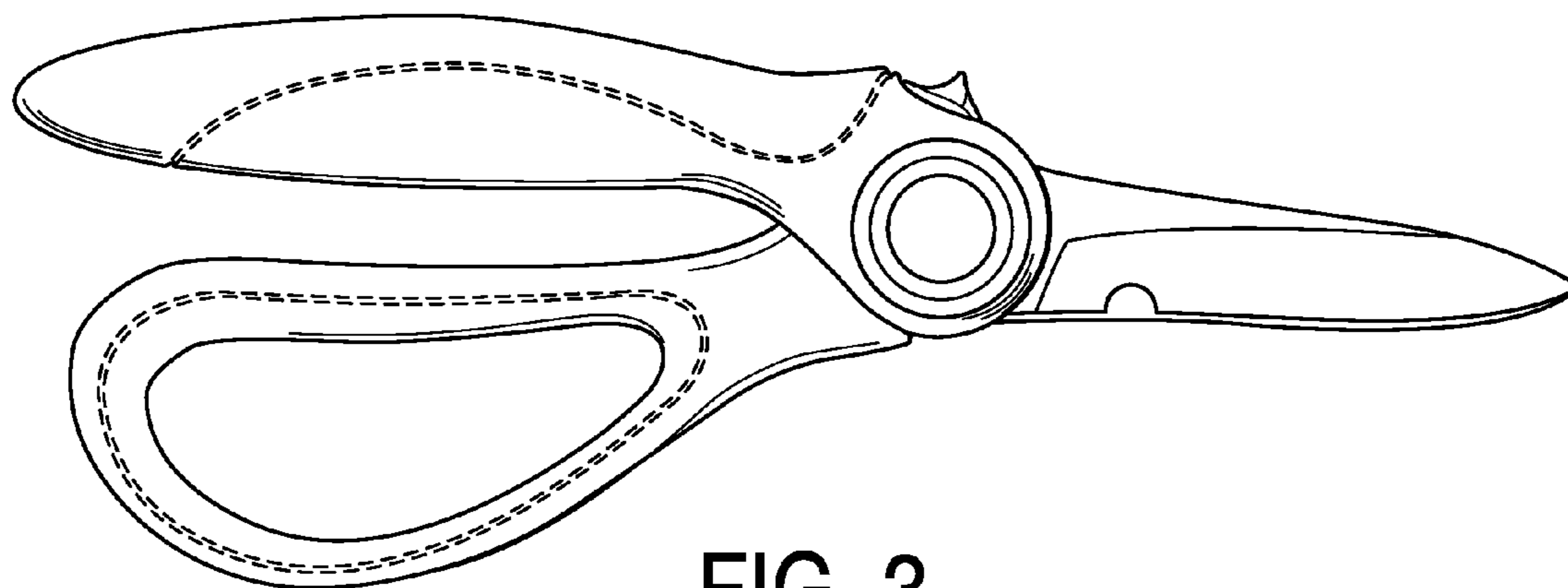

FIG. 3

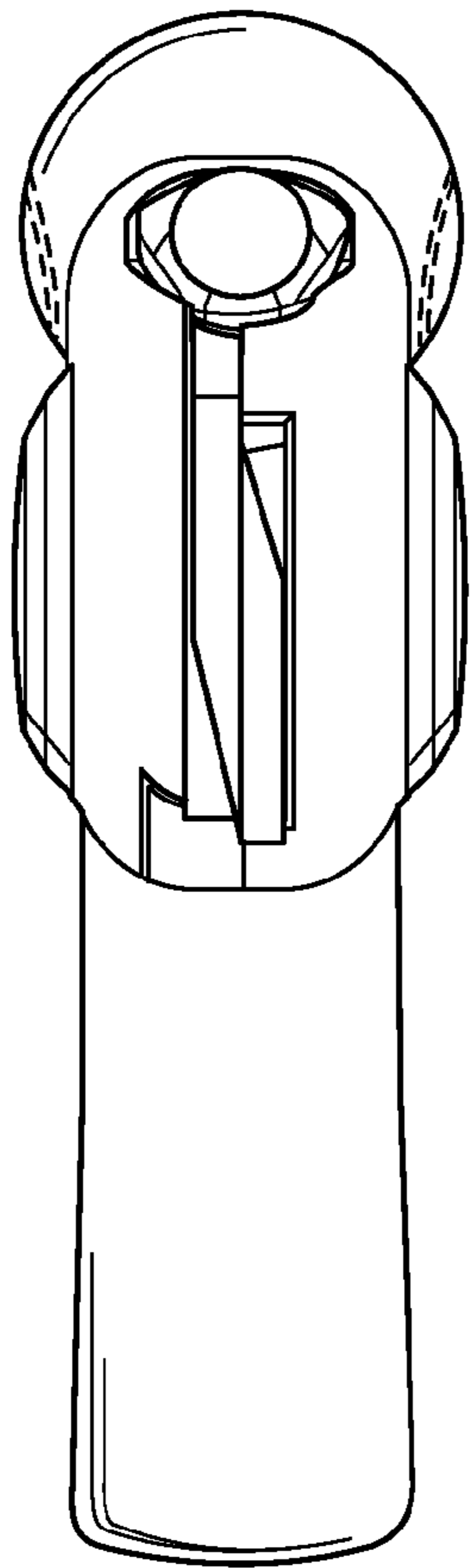

FIG. 4

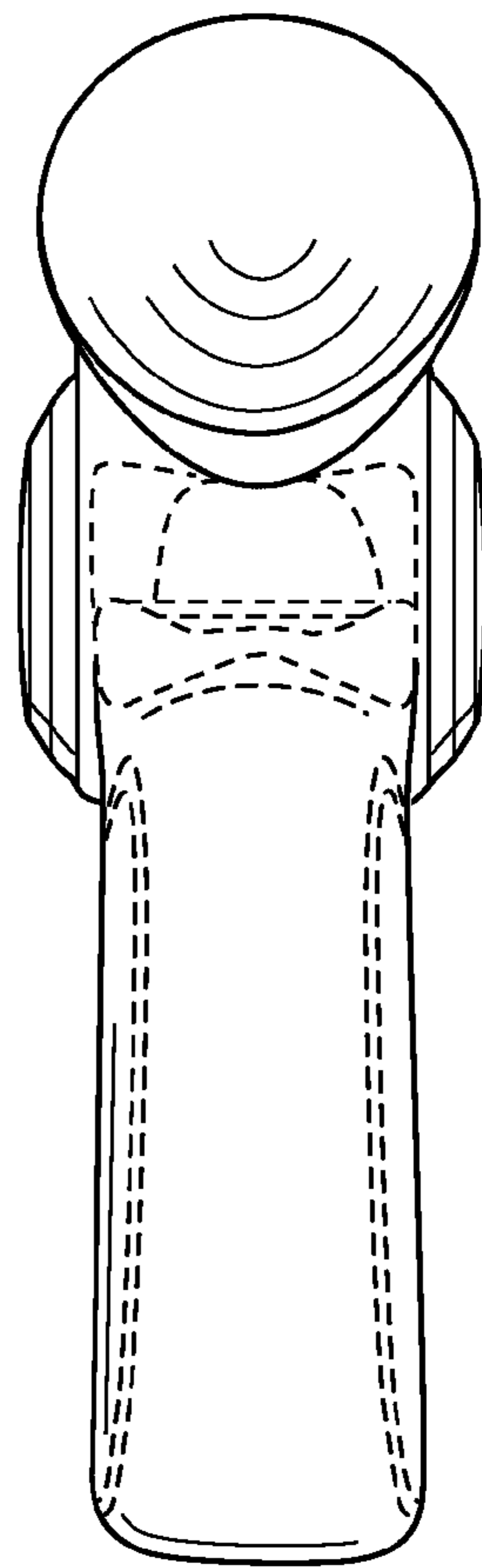

FIG. 5

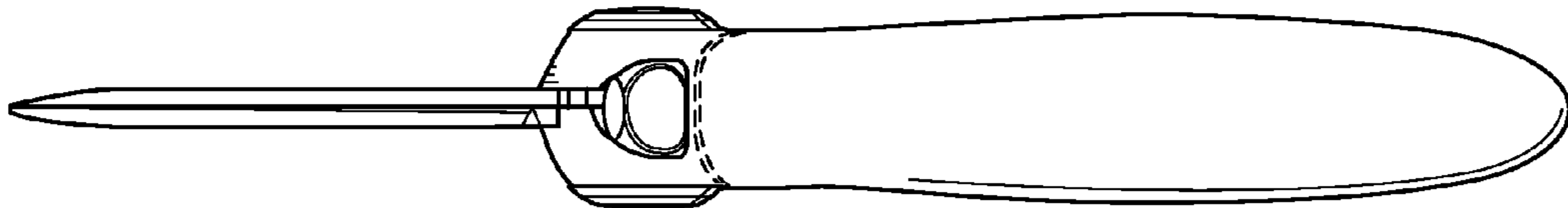

FIG. 6

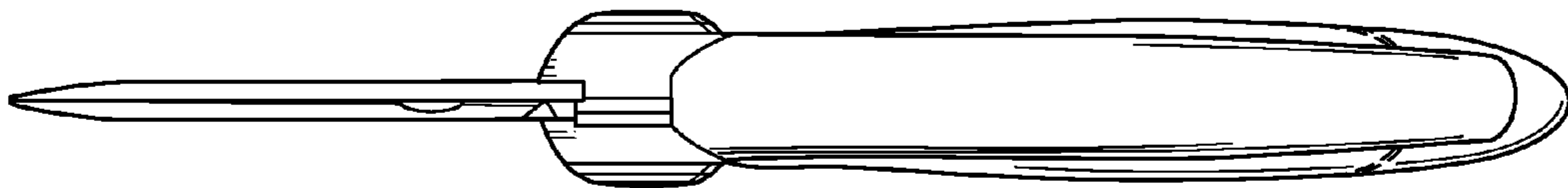

FIG. 7