



US00D623883S

(12) **United States Design Patent**  
**Wyatt**

(10) **Patent No.:** **US D623,883 S**

(45) **Date of Patent:** **\*\* Sep. 21, 2010**

(54) **TWO-PIECE FITTED LINEN FOR A LABOR AND DELIVERY MATTRESS**

2008/0115271 A1 5/2008 Wiley  
2008/0263767 A1\* 10/2008 Mooney ..... 5/490  
2008/0263768 A1 10/2008 Balasundharam

(76) Inventor: **Janet R. Wyatt**, 1405 Harris Ct.,  
Antioch, CA (US) 94509

\* cited by examiner

(\*\*) Term: **14 Years**

*Primary Examiner*—Janice E Seeger  
(74) *Attorney, Agent, or Firm*—Crossley Patent Law; Mark A. Crossley

(21) Appl. No.: **29/357,840**

(22) Filed: **Mar. 18, 2010**

(57) **CLAIM**

(51) **LOC (9) Cl.** ..... **06-09**

The ornamental design for a two-piece fitted linen for a labor and delivery mattress, as shown and described.

(52) **U.S. Cl.** ..... **D6/602; D6/601**

(58) **Field of Classification Search** ..... D6/595,  
D6/596, 601, 602, 603, 605; 5/482, 485,  
5/488–491, 494–502, 907, 632; D24/183,  
D24/184

**DESCRIPTION**

See application file for complete search history.

FIG. 1 is a top plan view of a two-piece fitted linen for a labor and delivery mattress showing my new design with a bottom section separated from a top section for clarity;

(56) **References Cited**

**U.S. PATENT DOCUMENTS**

3,222,694	A *	12/1965	Schick	.....	5/653
4,703,530	A	11/1987	Gusman		
4,736,477	A *	4/1988	Moore	.....	5/648
D330,990	S *	11/1992	Barnes	.....	D6/603
D383,028	S	9/1997	Pierce		
6,041,456	A	3/2000	Pharr		
7,475,439	B1 *	1/2009	Cox et al.	.....	5/632
7,487,561	B2	2/2009	Ho		
2003/0037374	A1	2/2003	Ciaglia et al.		

FIG. 2 is a bottom plan view thereof;

FIG. 3 is a front elevation view thereof;

FIG. 4 is a rear elevation view thereof;

FIG. 5 is a right elevation view thereof, the opposite side being a mirror image of the shown; and,

FIG. 6 is an isometric view thereof.

The broken lines in the drawings depict environmental subject matter only and form no part of the claimed design.

**1 Claim, 5 Drawing Sheets**

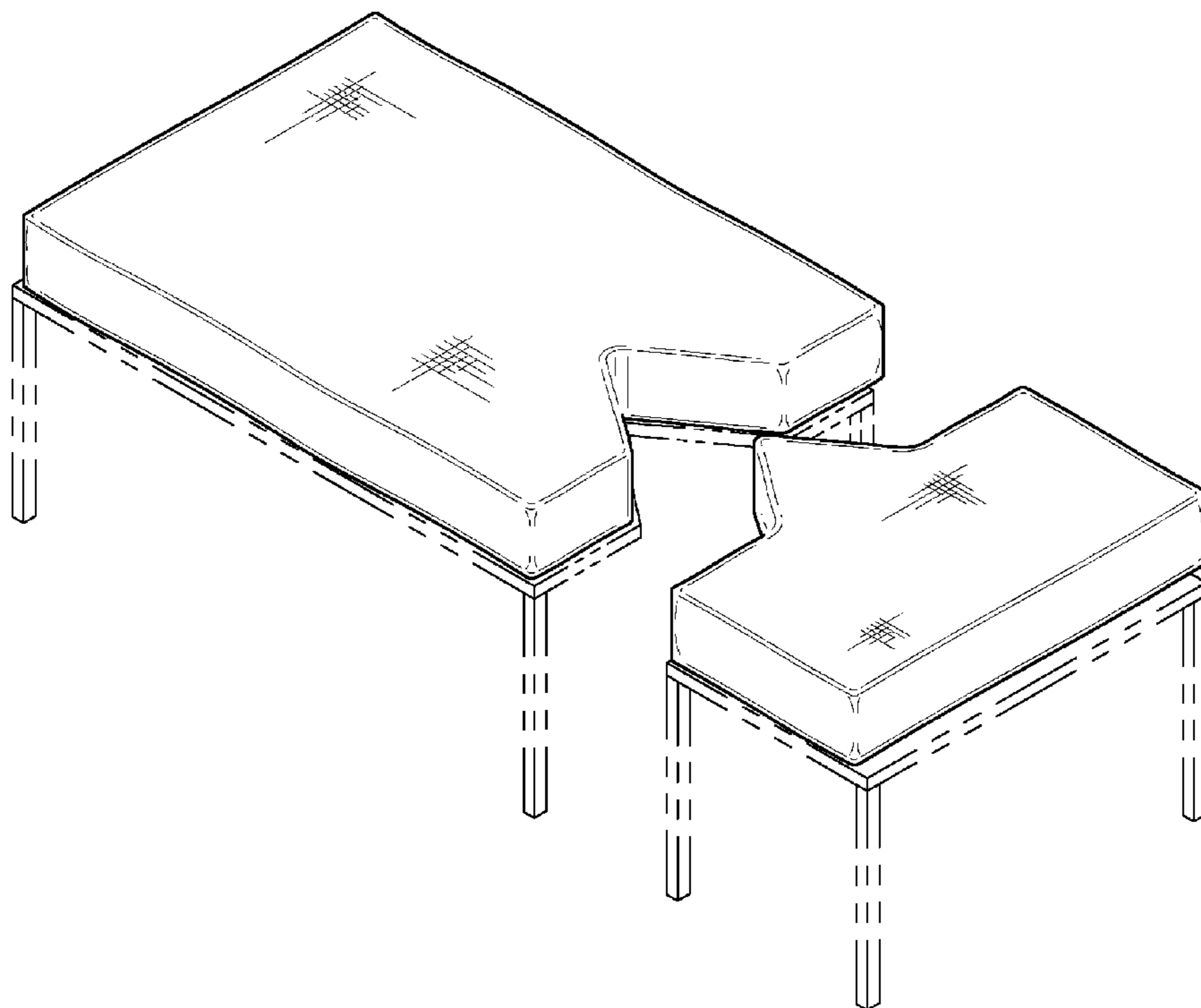

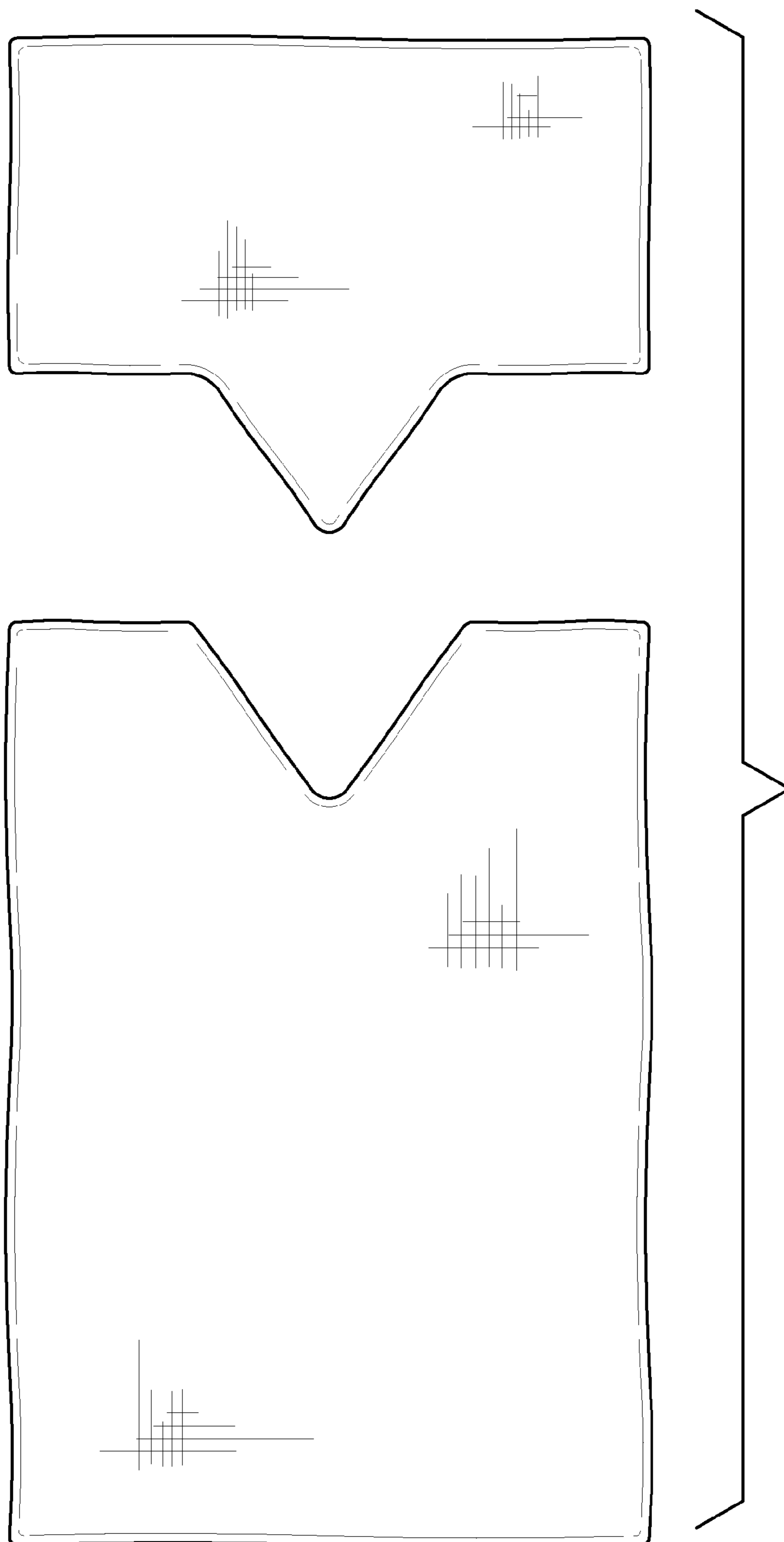

FIG. 1

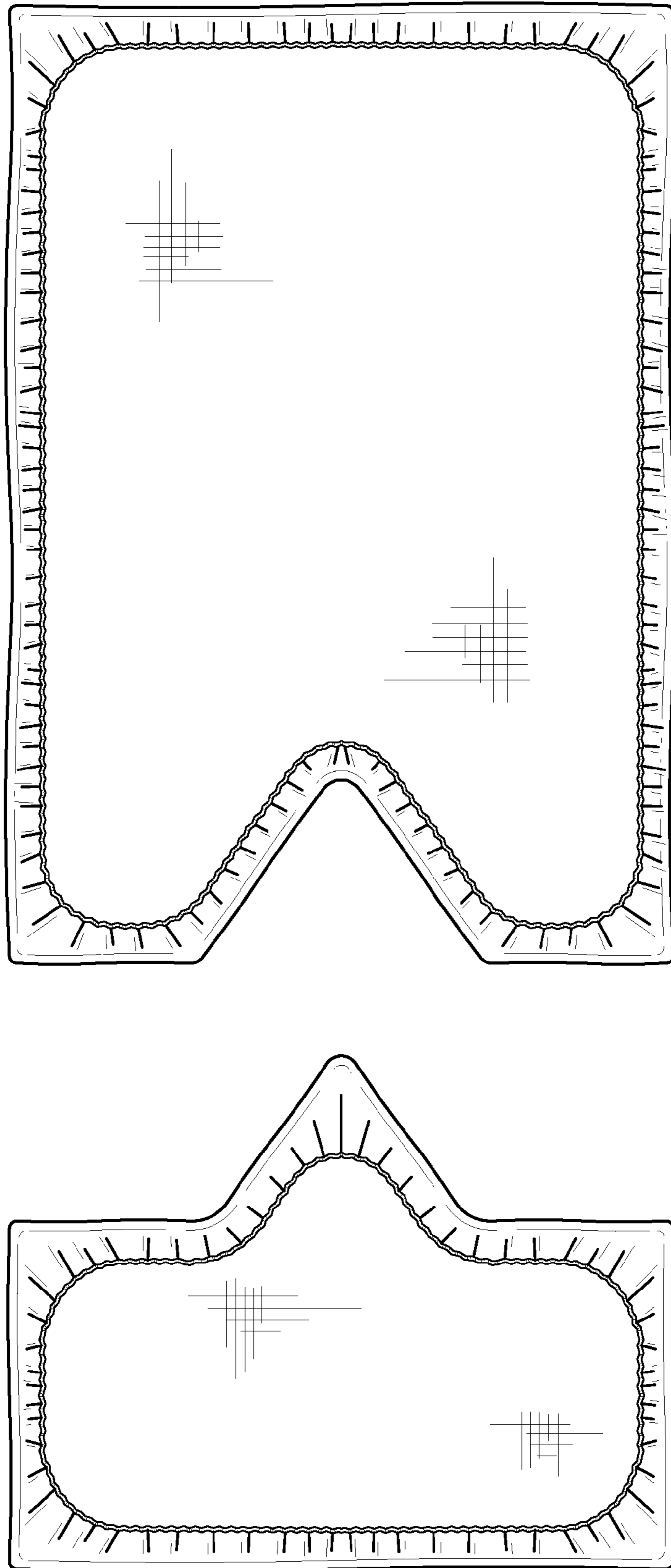

FIG. 2

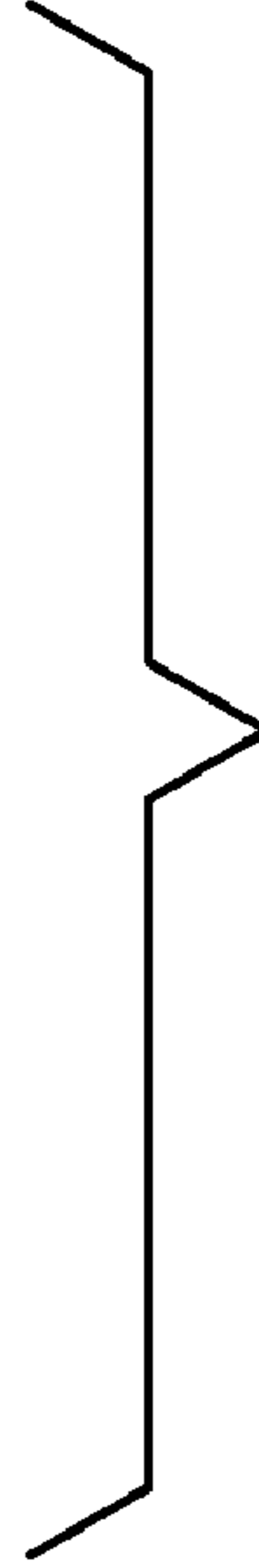
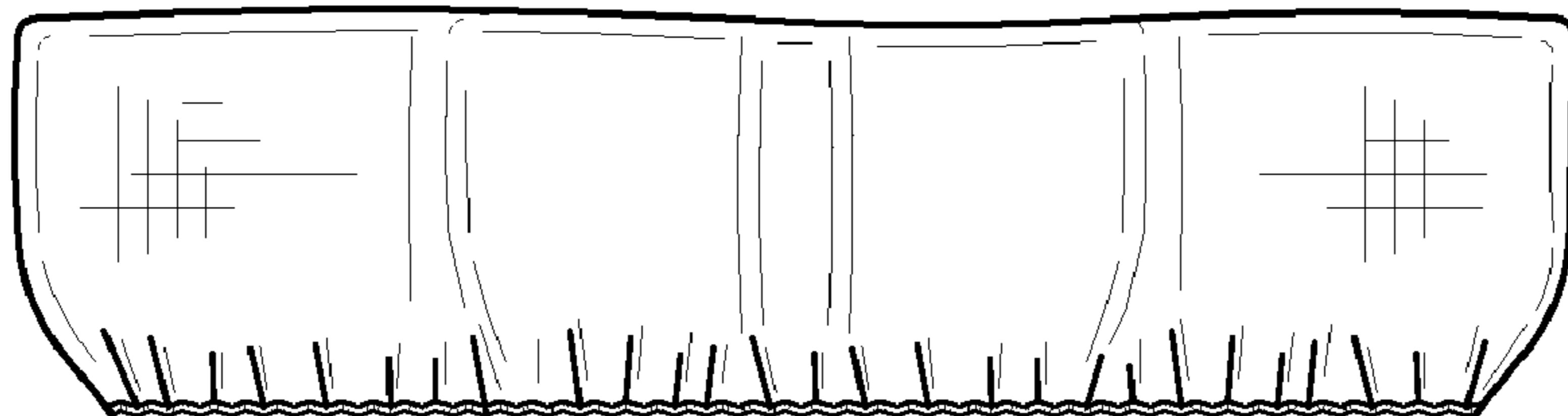
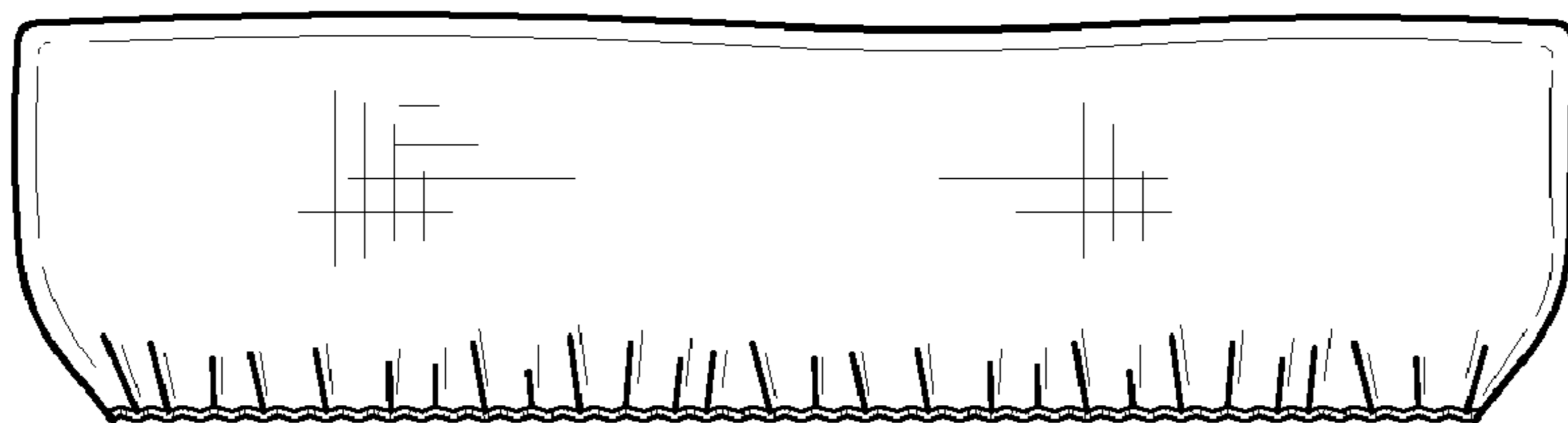
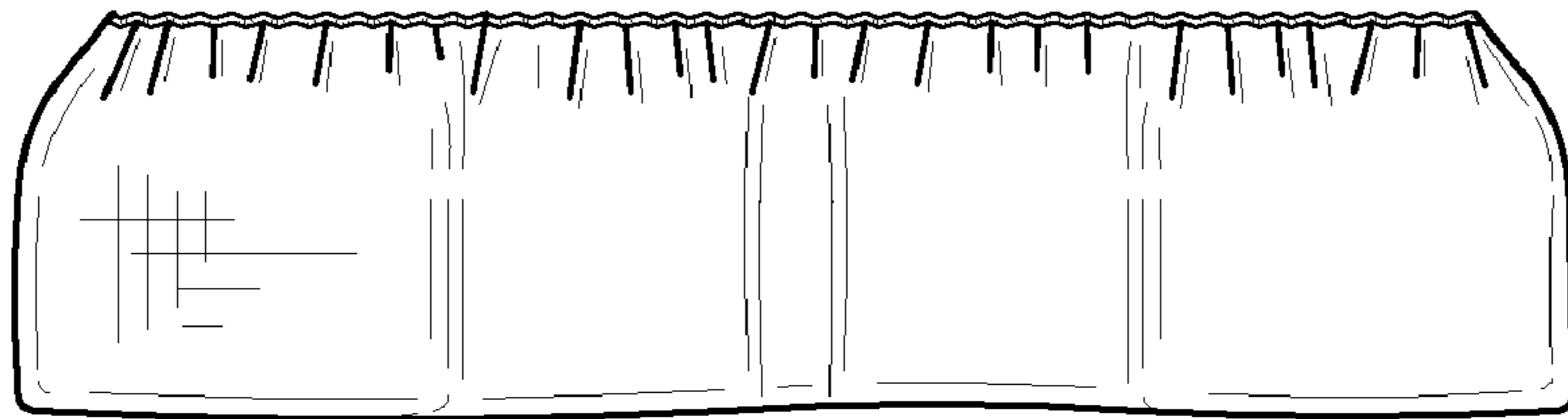
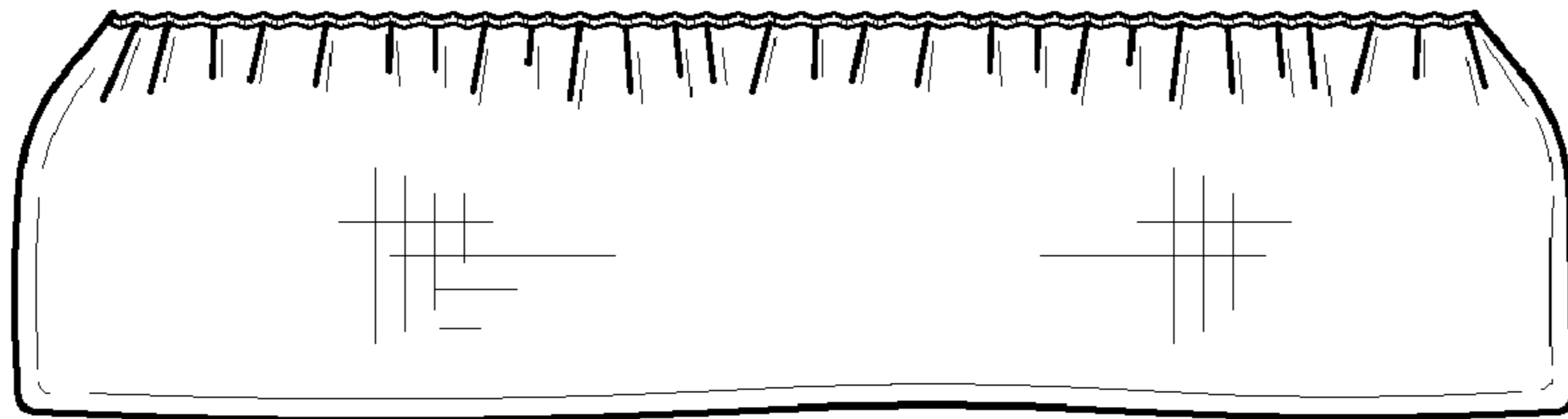

FIG. 4

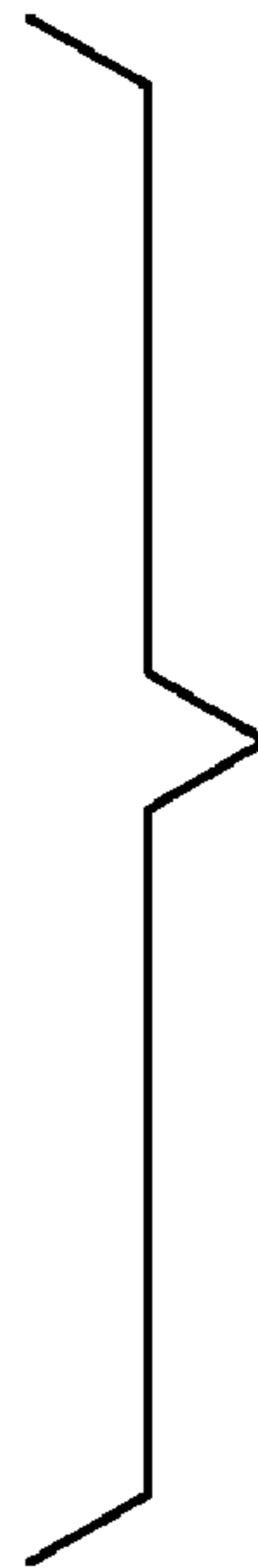

FIG. 3

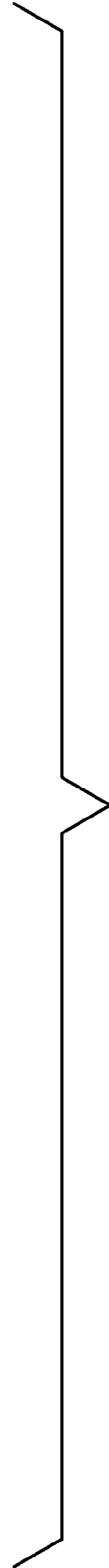
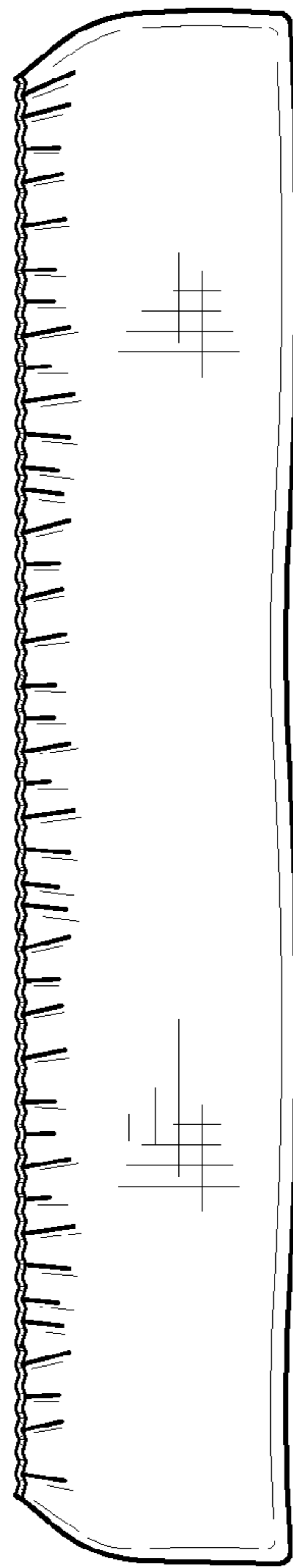
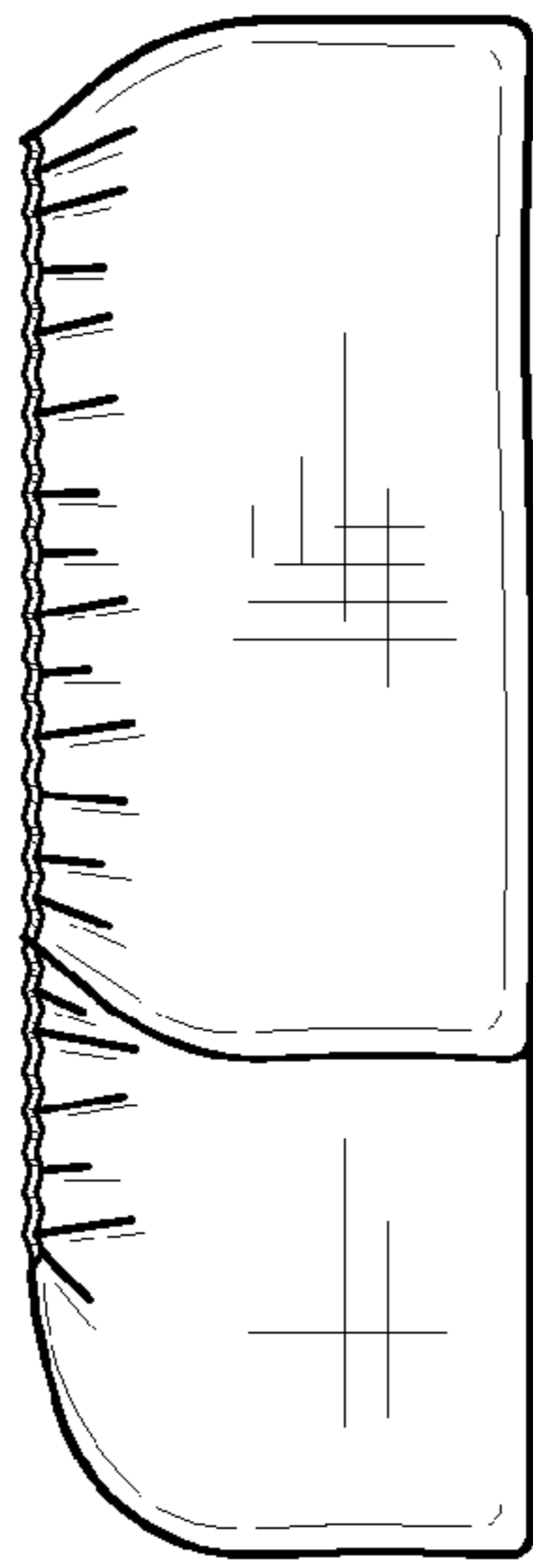

FIG. 5

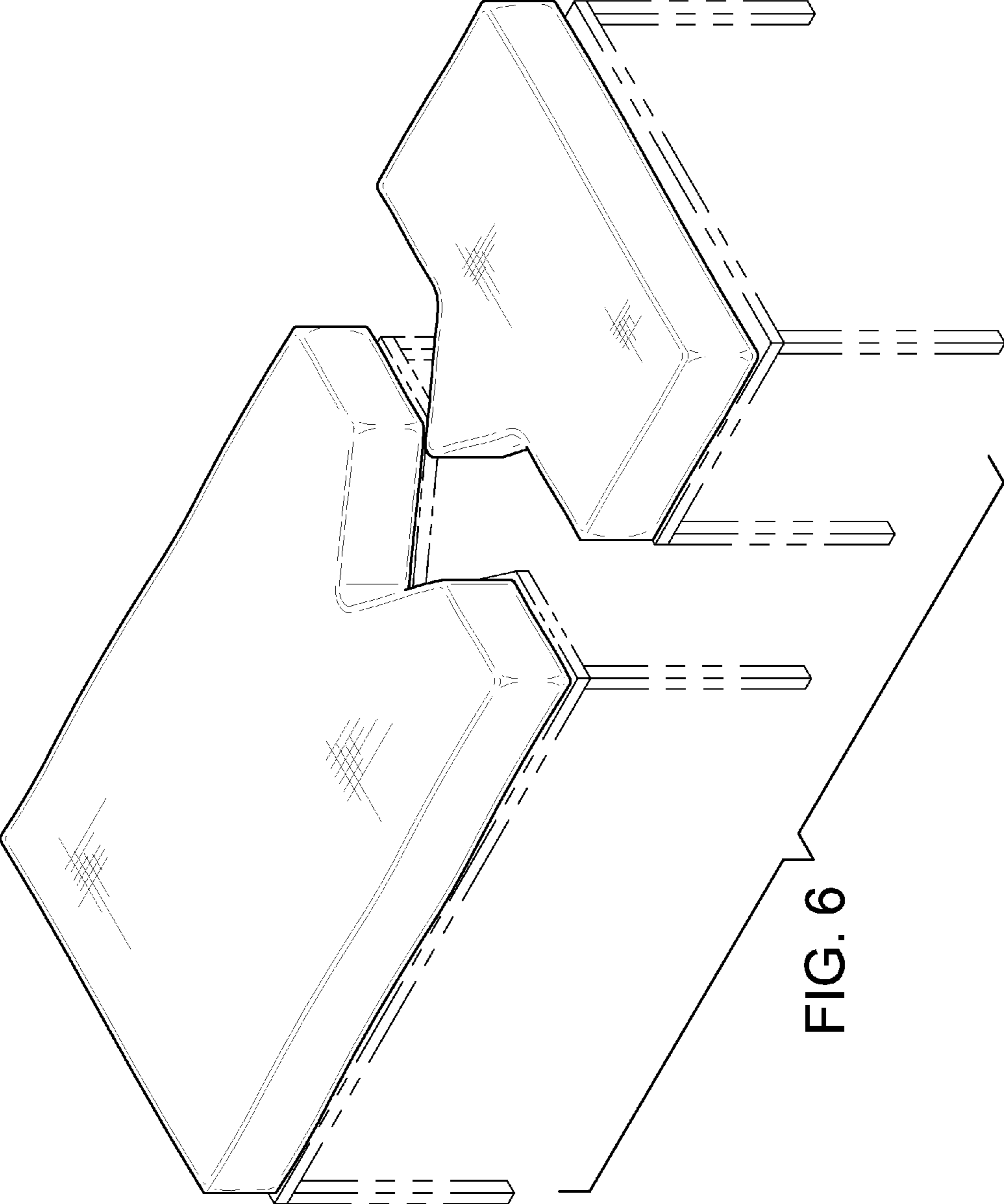

FIG. 6