



US00D623816S

(12) **United States Design Patent**
Pardo et al.

(10) **Patent No.:** **US D623,816 S**

(45) **Date of Patent:** **** Sep. 14, 2010**

(54) **IRON**

(75) Inventors: **Fernando Pardo**, Moorpark, CA (US);
Bianca Fleischer, Santa Monica, CA (US)

(73) Assignee: **Sunbeam Products, Inc.**, Boca Raton, FL (US)

(**) Term: **14 Years**

(21) Appl. No.: **29/355,638**

(22) Filed: **Feb. 11, 2010**

(51) **LOC (9) Cl.** **07-05**

(52) **U.S. Cl.** **D32/70**

(58) **Field of Classification Search** D32/73,
D32/72, 71, 70, 69, 68, 35; 392/404; 38/97,
38/96, 93, 88, 77.9, 77.83, 77.82, 77.81,
38/77.8, 77.7, 77.6, 77.5, 77.3, 77.1; 219/251,
219/245

See application file for complete search history.

(56) **References Cited**

U.S. PATENT DOCUMENTS

D167,096 S *	6/1952	Perl	D32/69
D173,308 S *	10/1954	Jepson et al.	D32/69
2,725,453 A *	11/1955	Haller	219/254
2,792,652 A *	5/1957	Dawson	38/82
D182,922 S *	5/1958	Rawson, Jr. et al.	D32/69
D205,903 S *	10/1966	Marshall et al.	D32/69
3,308,566 A *	3/1967	Jepson et al.	38/77.7
3,672,080 A *	6/1972	Murphy et al.	38/90
D283,934 S *	5/1986	Tsuji	D32/69
D286,095 S *	10/1986	Van Asten	D32/69

D300,479 S *	3/1989	Paulin	D32/69
D317,519 S *	6/1991	Van Surksun	D32/70
5,349,160 A *	9/1994	Hazan et al.	219/250
D371,878 S *	7/1996	Muller	D32/69
D381,151 S *	7/1997	Lin	D32/69
D381,152 S *	7/1997	Lin	D32/69
D389,968 S *	1/1998	Sham	D32/70
D418,649 S *	1/2000	Stutzer et al.	D32/70
D488,275 S *	4/2004	Gudefin	D32/70
D552,318 S *	10/2007	Leslie et al.	D32/70
D590,562 S *	4/2009	Garman et al.	D32/69
D610,763 S *	2/2010	Massip et al.	D32/69

* cited by examiner

Primary Examiner—Austin Murphy

(74) *Attorney, Agent, or Firm*—Seth M. Blum

(57) **CLAIM**

The ornamental design for a iron, shown and described.

DESCRIPTION

FIG. 1 is a top front left perspective view of the iron showing the new design;

FIG. 2 is a front elevation view thereof;

FIG. 3 is a back elevation view thereof;

FIG. 4 is a right side elevation view thereof;

FIG. 5 is a left side elevation view thereof;

FIG. 6 is a top plan view thereof; and,

FIG. 7 is a bottom plan view thereof.

The broken lines in the drawings are for illustrative purposes only and form no part of the claimed design.

1 Claim, 3 Drawing Sheets

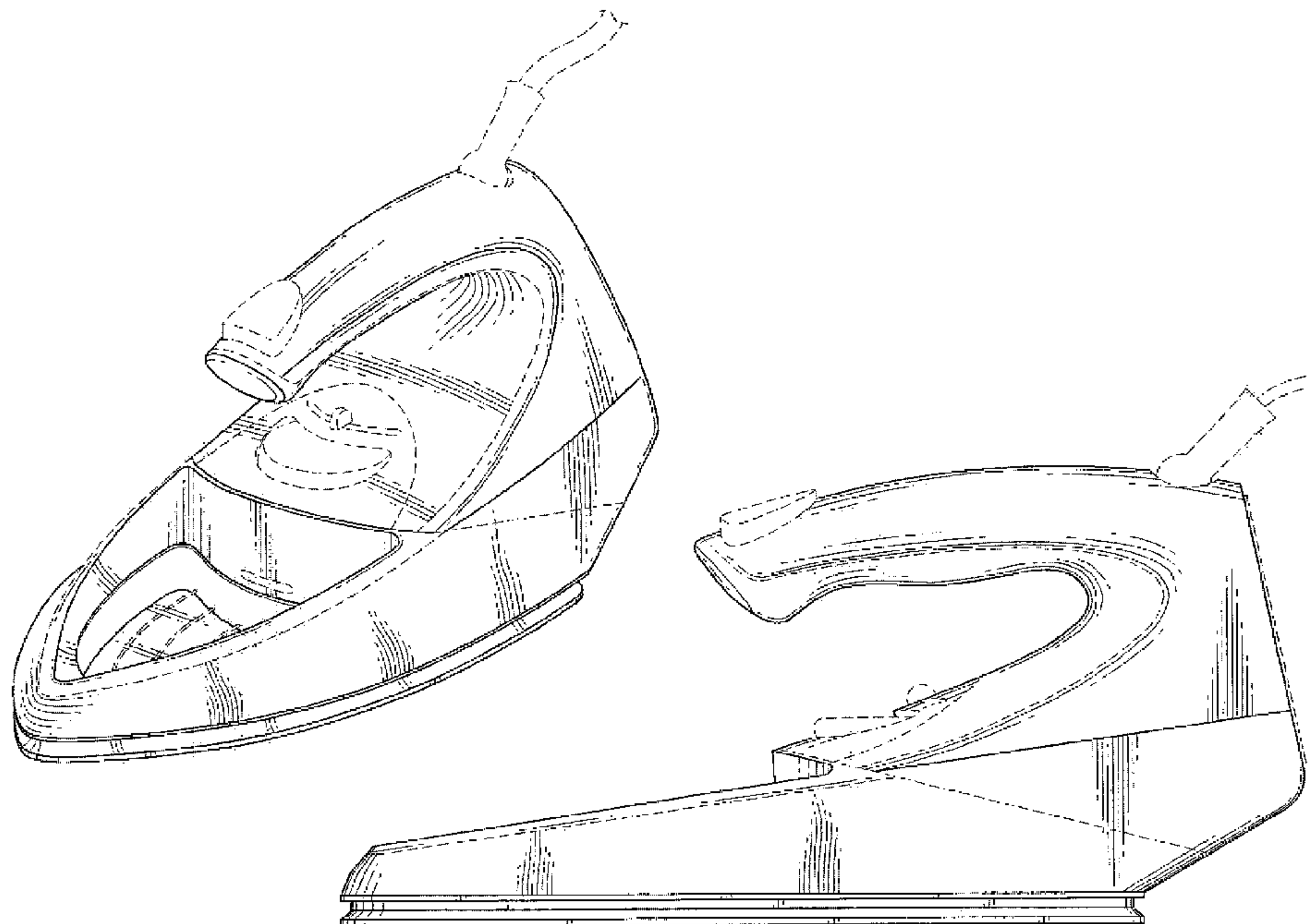

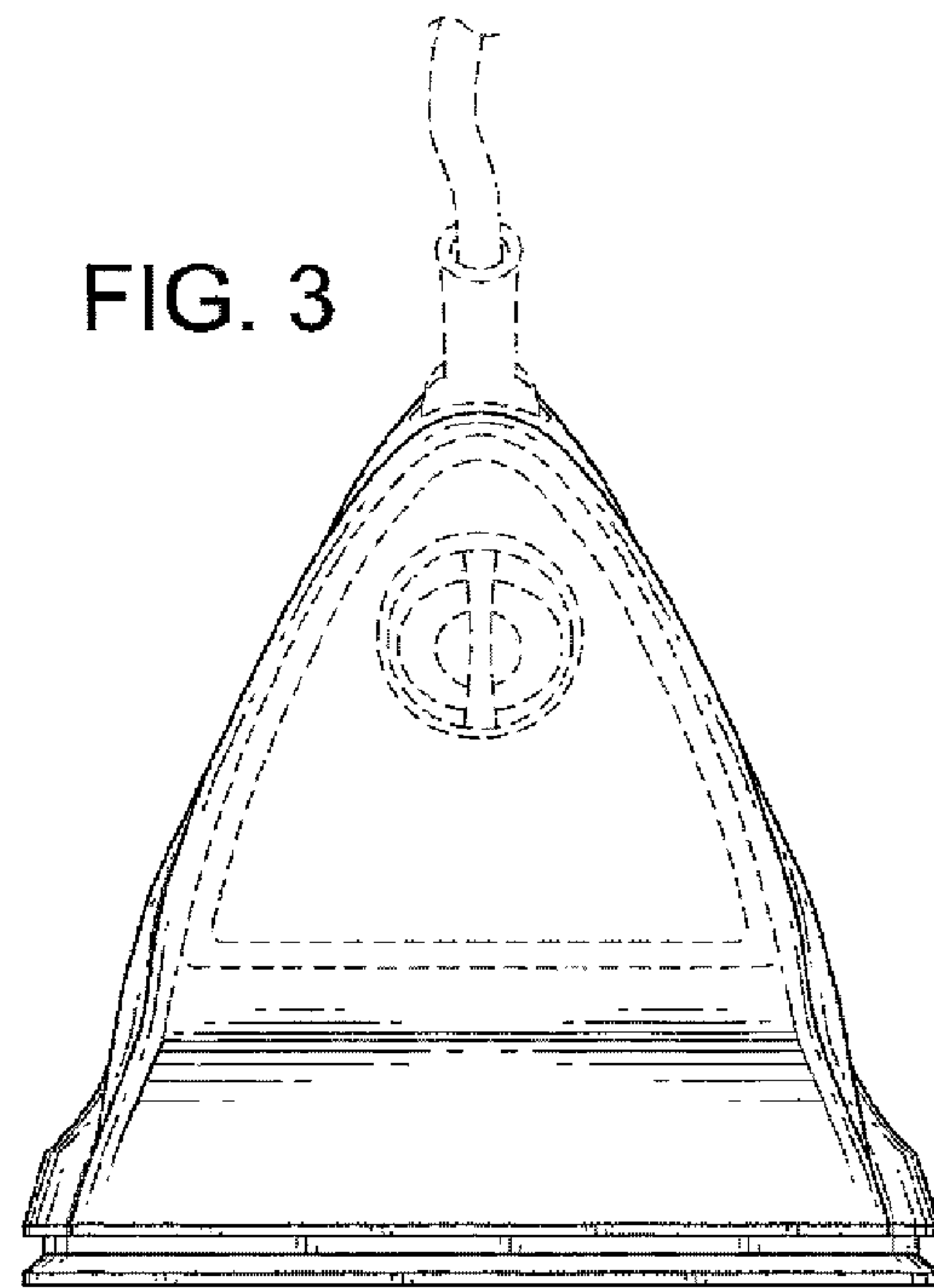
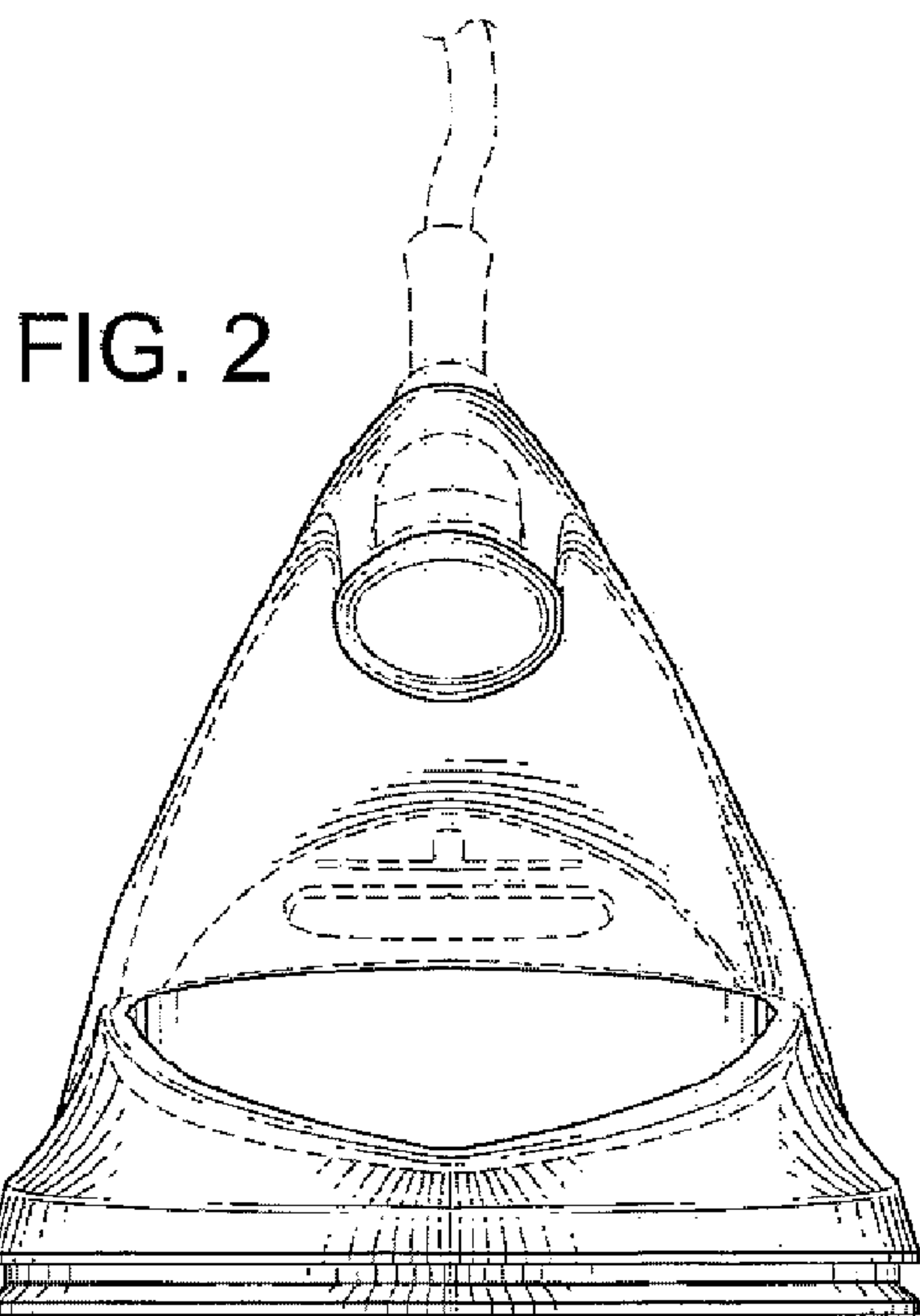
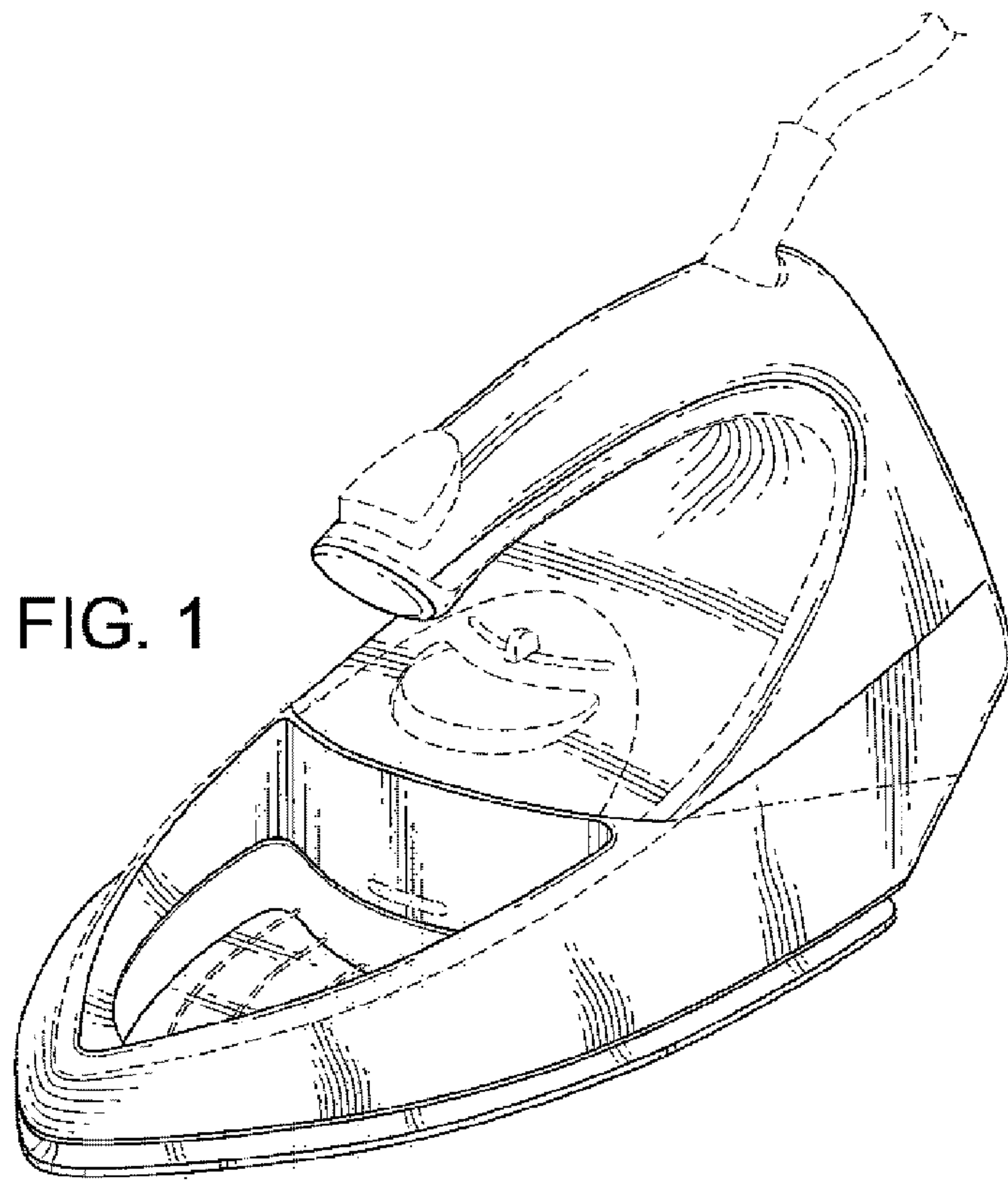

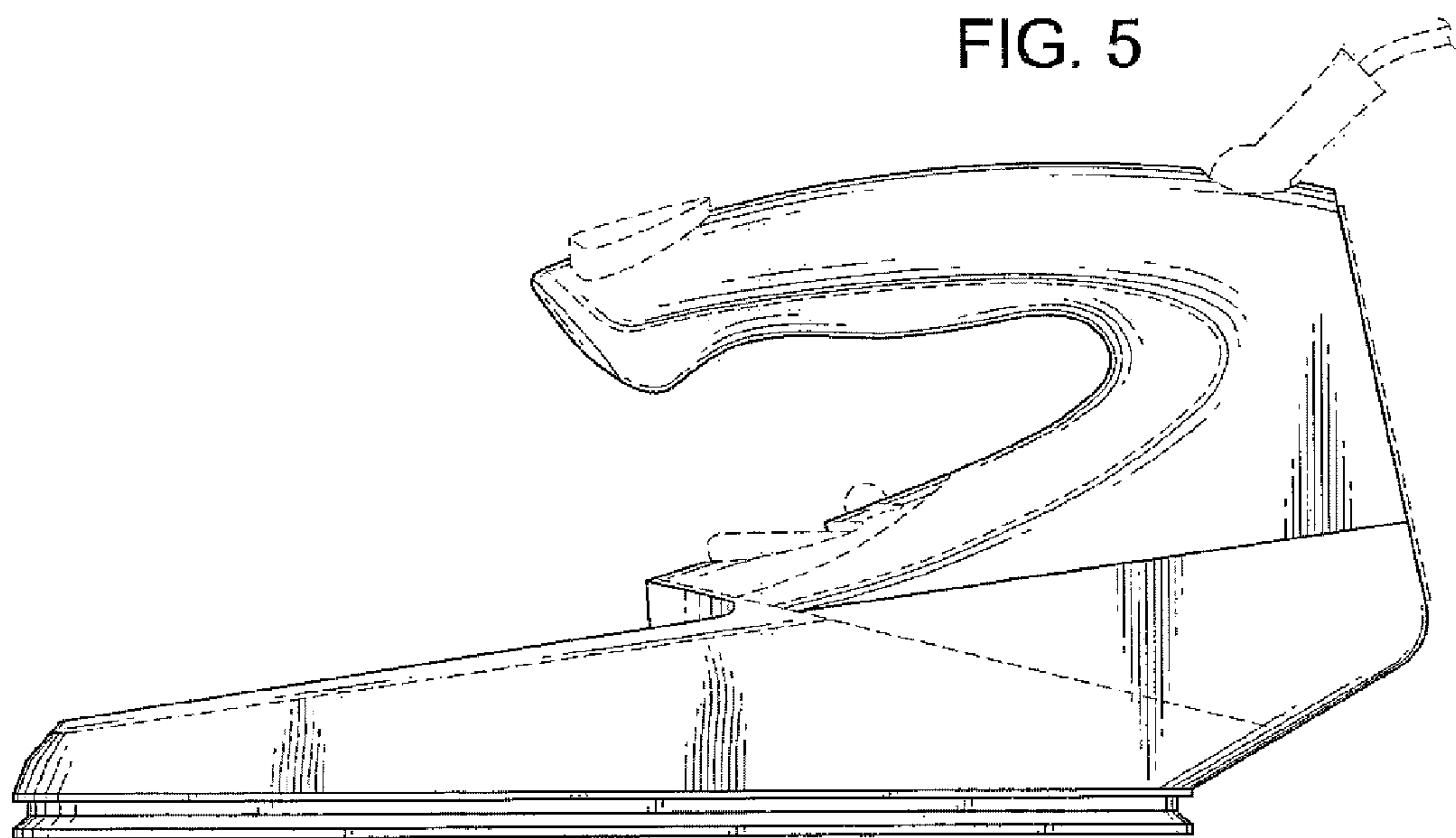
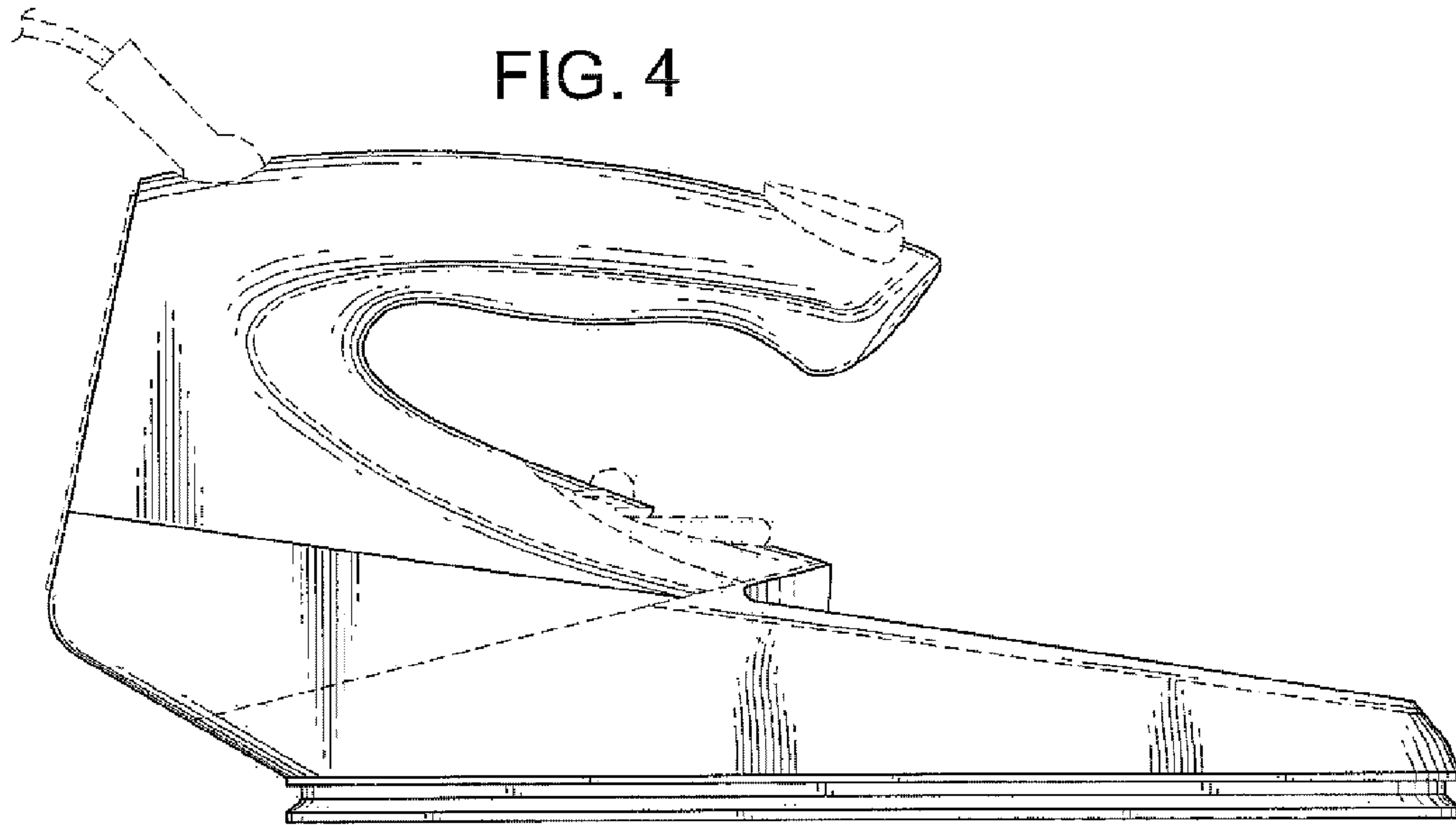

FIG. 6

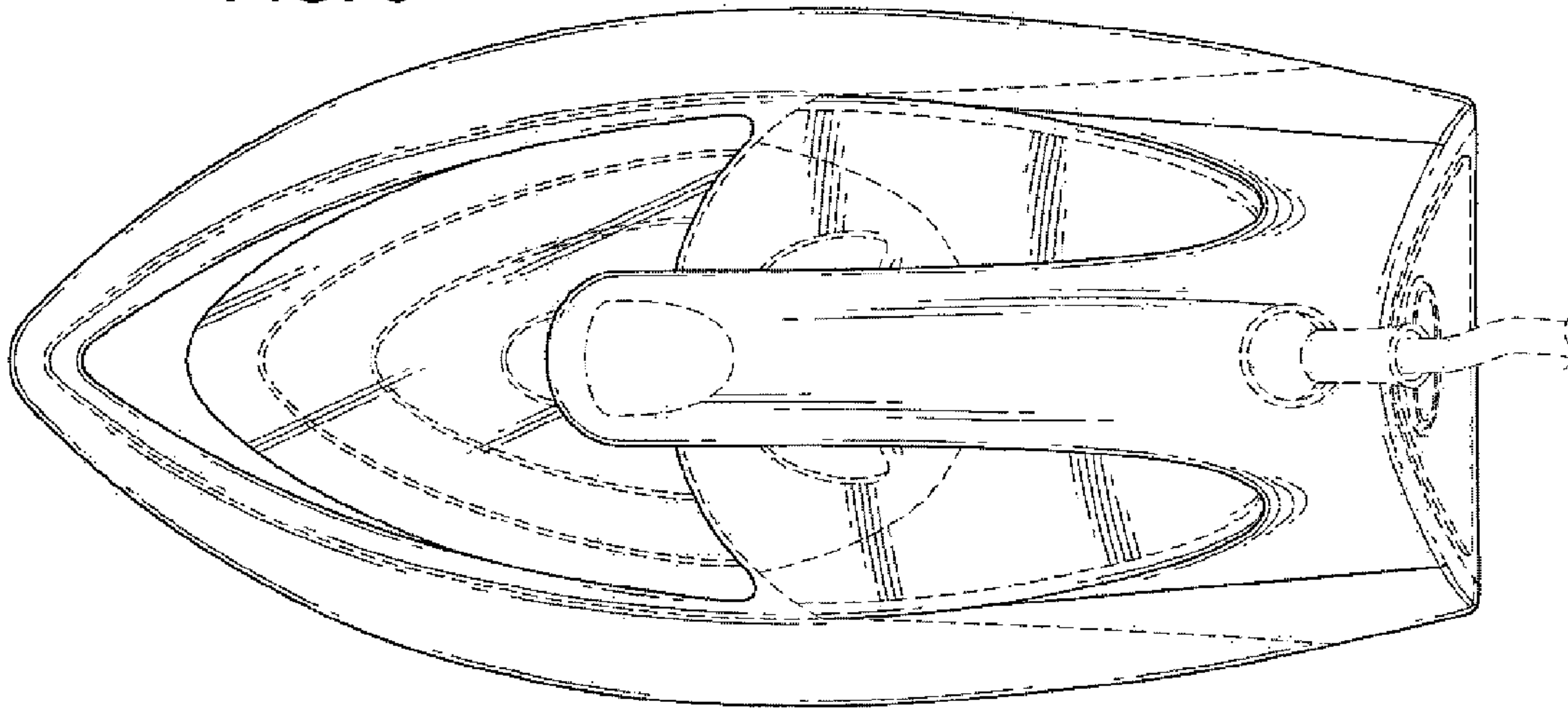

FIG. 7

