



US00D623815S

(12) **United States Design Patent**  
**Weaver**

(10) **Patent No.:** **US D623,815 S**

(45) **Date of Patent:** **\*\* Sep. 14, 2010**

(54) **MOP ROLLER**

(75) Inventor: **Jace A. Weaver**, Gilbertsville, PA (US)

(73) Assignee: **Quickie Manufacturing Corporation**,  
Cinnaminson, NJ (US)

(\*\*) Term: **14 Years**

(21) Appl. No.: **29/356,479**

(22) Filed: **Feb. 26, 2010**

(51) **LOC (9) Cl.** ..... **04-01**

(52) **U.S. Cl.** ..... **D32/50**

(58) **Field of Classification Search** ..... D32/35,  
D32/40, 50-52; D4/199; 15/104.94, 119.1,  
15/150, 209.1, 223-224, 228, 231, 244.1,  
15/244.4, 229.1, 229.9, 119.2; 401/132,  
401/138-140

See application file for complete search history.

(56) **References Cited**

**U.S. PATENT DOCUMENTS**

2,218,862	A *	10/1940	Vredenburg	.....	15/209.1
3,406,420	A *	10/1968	Siemund	.....	15/209.1
D232,617	S *	9/1974	Albrecht	.....	D32/50
4,391,014	A *	7/1983	Pitzen	.....	15/231
4,852,203	A *	8/1989	LaBelle	.....	15/244.1
D440,770	S *	4/2001	Chen	.....	D32/40
D441,200	S *	5/2001	Chen	.....	D32/52
6,785,927	B2 *	9/2004	Lesley et al.	.....	15/119.1
D586,966	S *	2/2009	Nobile et al.	.....	D32/50

D590,115 S \* 4/2009 Zach et al. .... D32/40  
2007/0000082 A1 \* 1/2007 Picard et al. .... 15/209.1

\* cited by examiner

*Primary Examiner*—T. Chase Nelson

(74) *Attorney, Agent, or Firm*—Wildman, Harrold, Allen &  
Dixon LLP

(57) **CLAIM**

I claim the ornamental design for a mop roller, as shown and described.

**DESCRIPTION**

FIG. 1 is a top front perspective view of a mop roller shown in an exemplary environment such as, for example, a mop.

FIG. 2 is a bottom front perspective view of the mop roller shown in FIG. 1.

FIG. 3 is a bottom view of the mop roller shown in FIG. 1.

FIG. 4 is a top view of the mop roller shown in FIG. 1.

FIG. 5 is a rear view of the mop roller shown in FIG. 1.

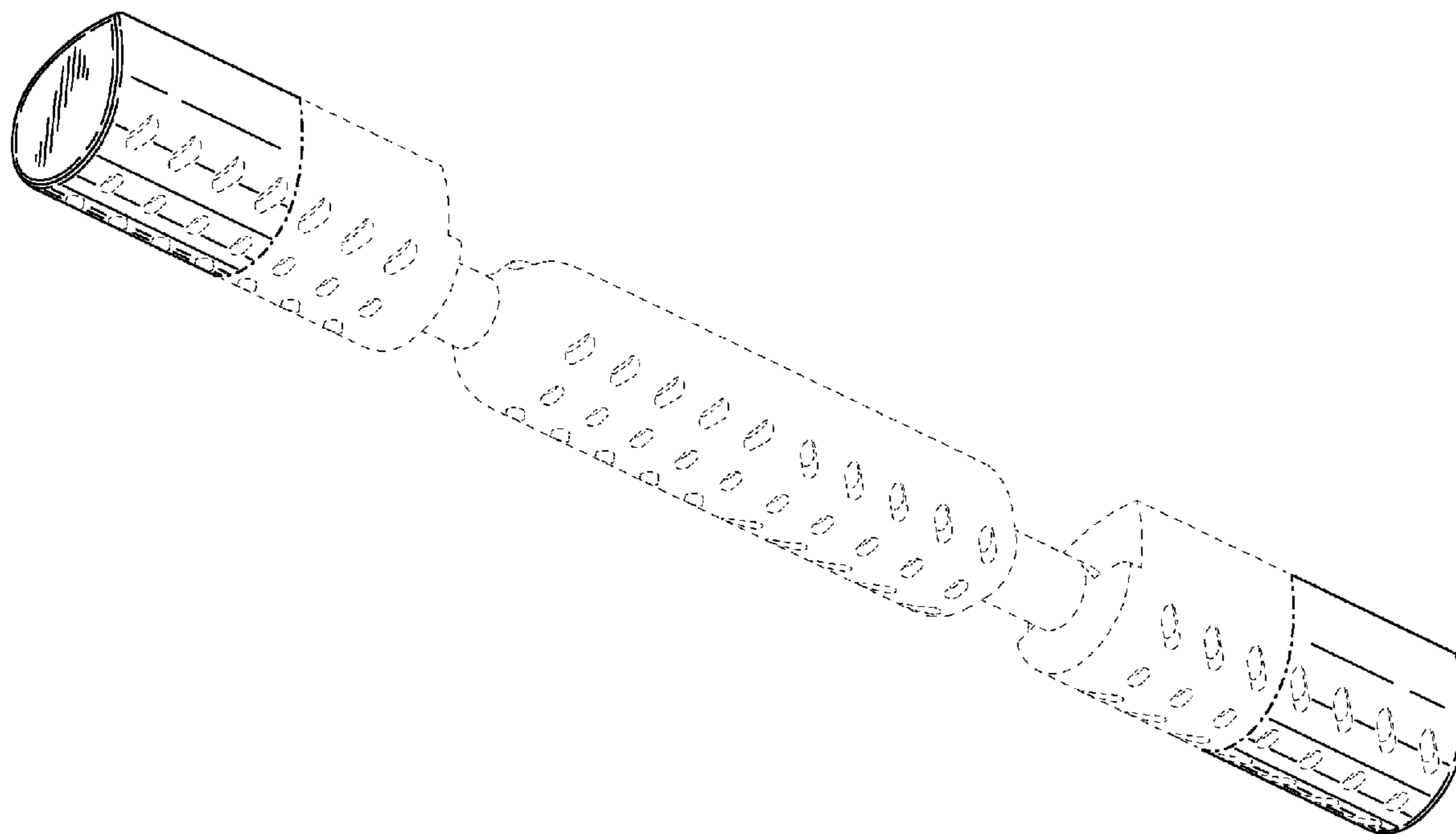
FIG. 6 is a front view of the mop roller shown in FIG. 1.

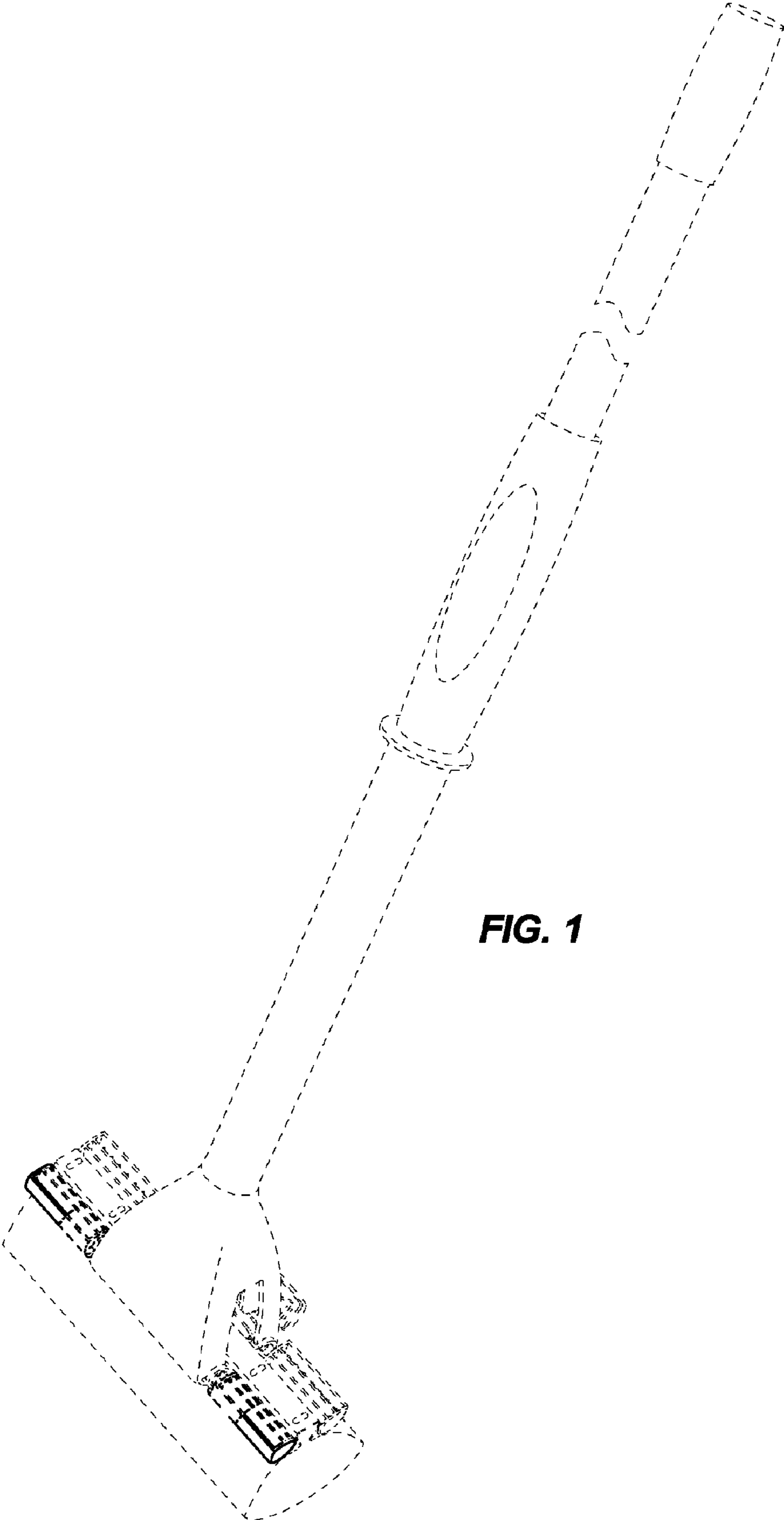
FIG. 7 is a left side view of the mop roller shown in FIG. 1; and,

FIG. 8 is a right side view of the mop roller shown in FIG. 1.

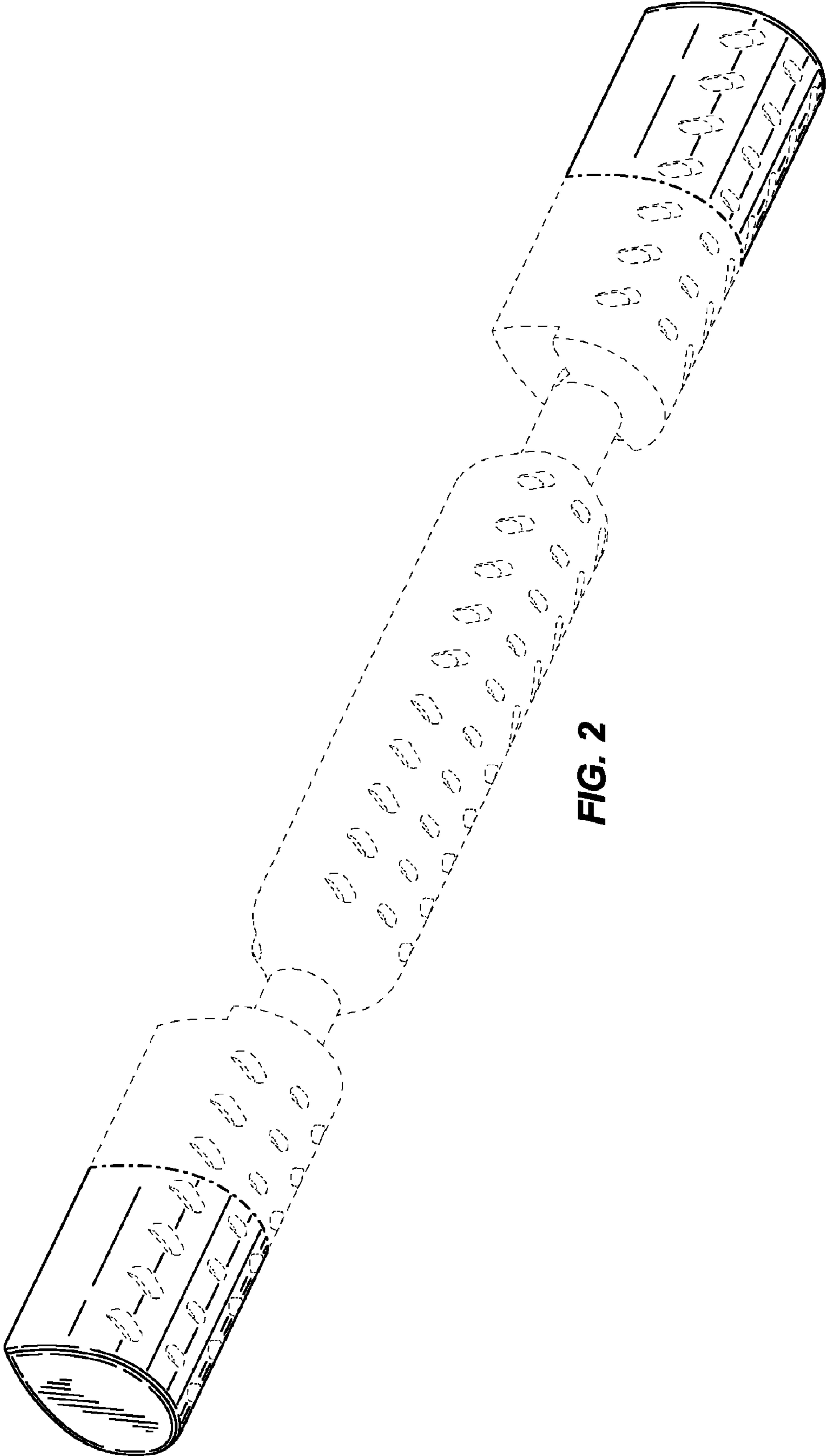
The portions of the mop roller and the environment shown in broken lines are for illustrative purposes only and form no part of the claimed design.

**1 Claim, 5 Drawing Sheets**

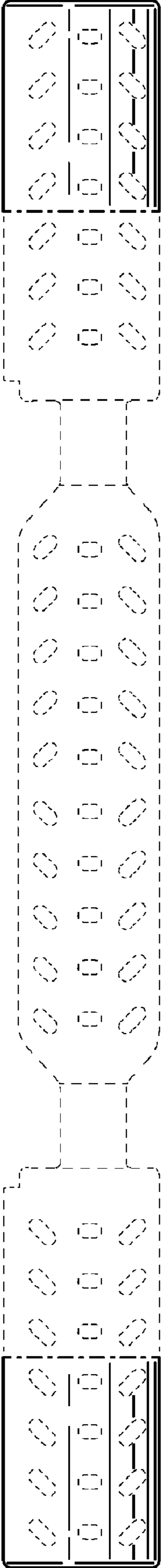




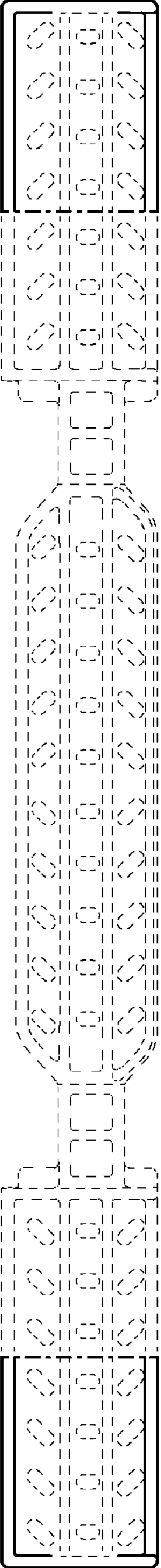
**FIG. 1**



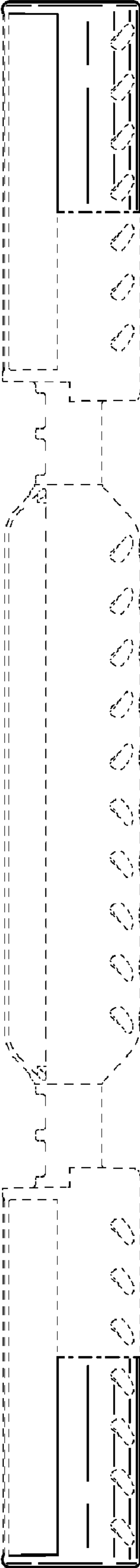
**FIG. 2**



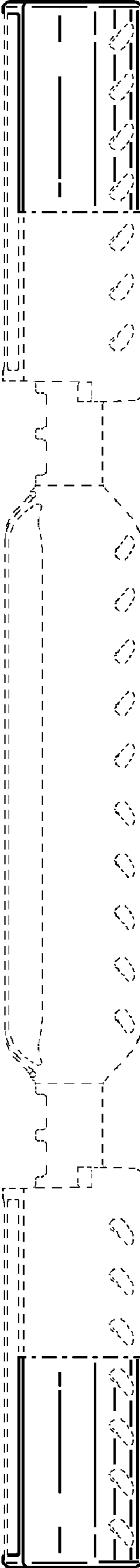
**FIG. 3**



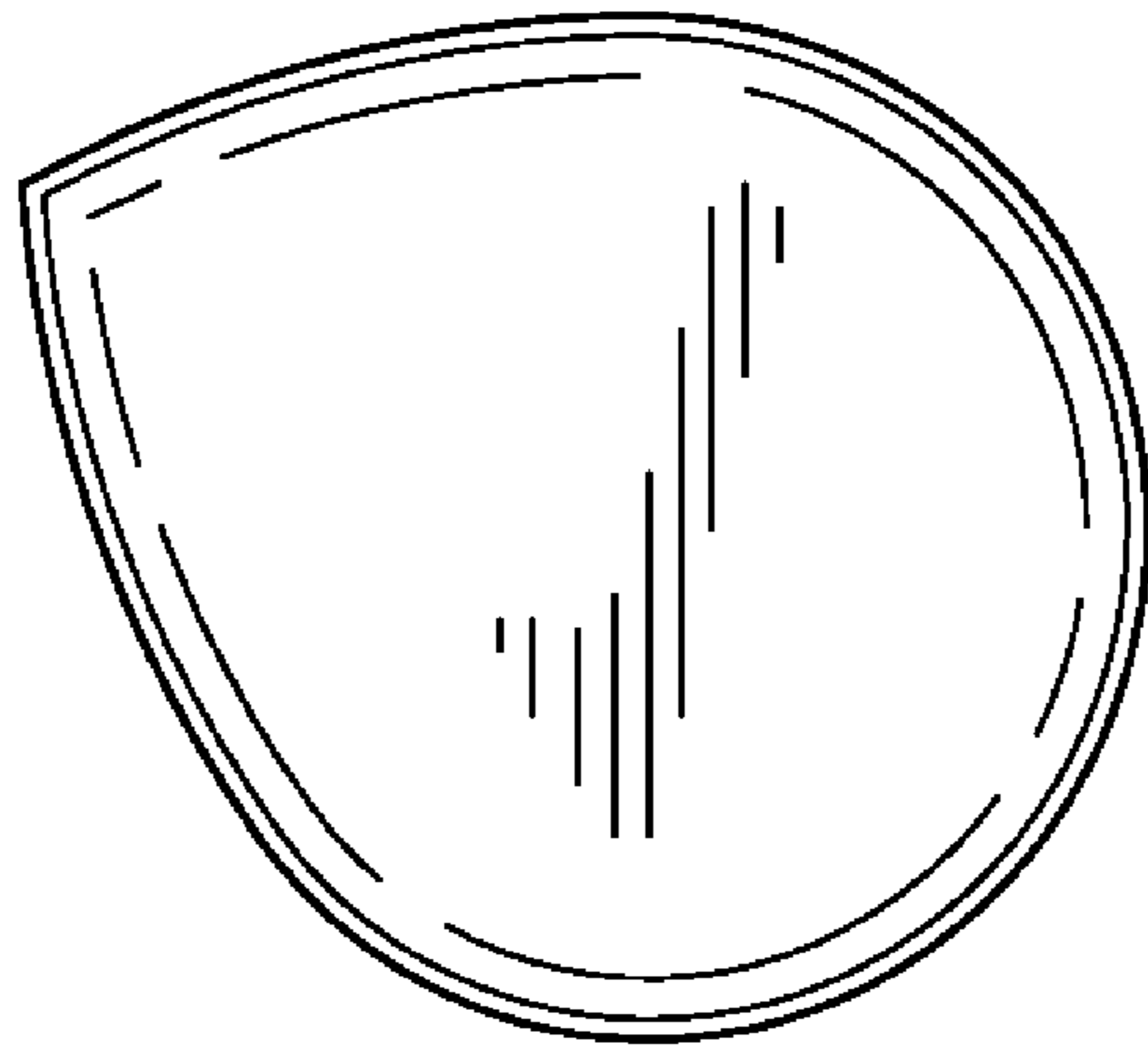
**FIG. 4**



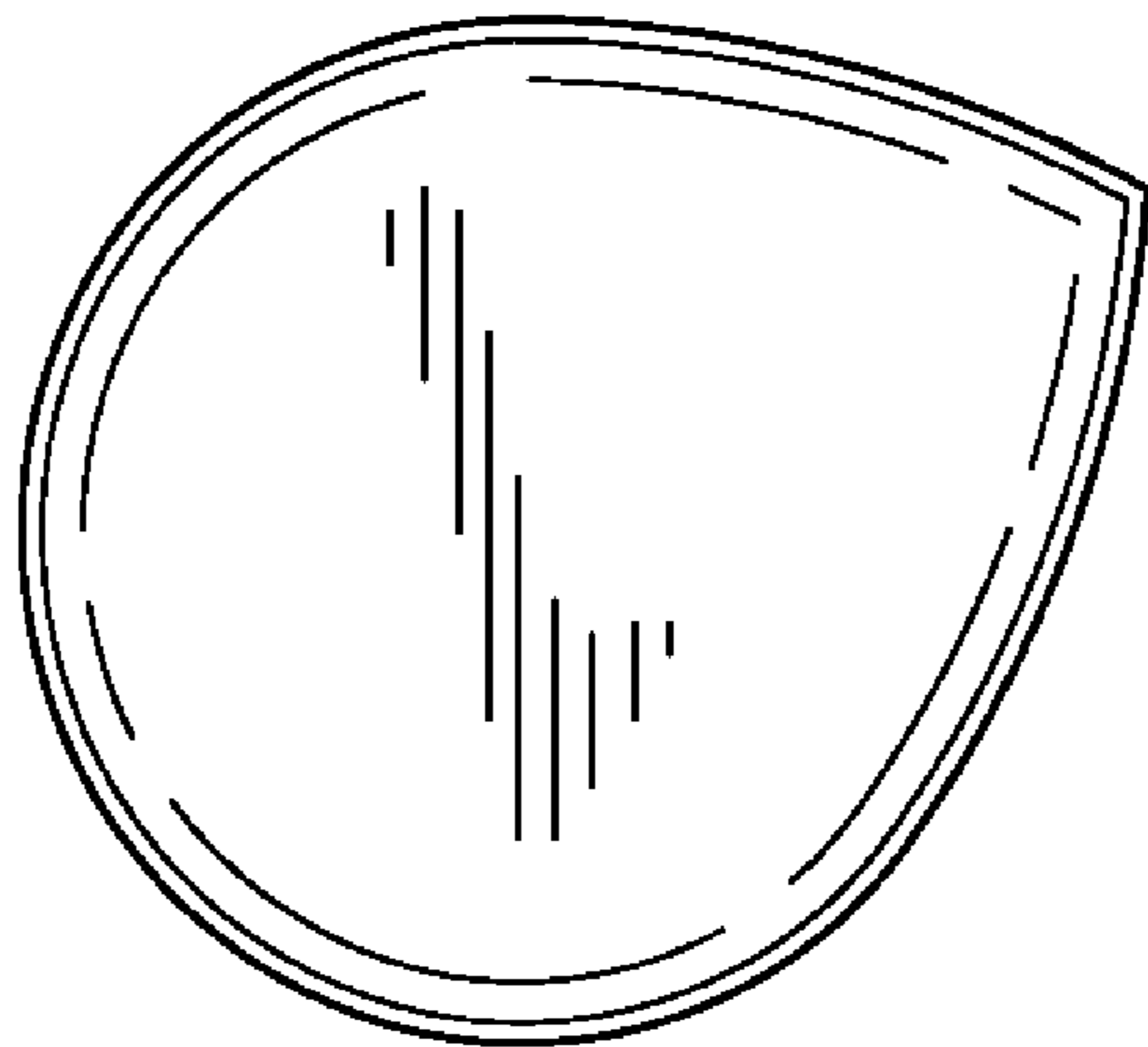
**FIG. 5**



**FIG. 6**



**FIG. 7**



**FIG. 8**