



US00D623722S

(12) **United States Design Patent**
Tinius

(10) **Patent No.:** **US D623,722 S**

(45) **Date of Patent:** **** Sep. 14, 2010**

(54) **SPRAYER**

(75) Inventor: **Michael Tinius**, Ulm (DE)

(73) Assignee: **Andreas Stihl AG Co. KG**, Waiblingen (DE)

(**) Term: **14 Years**

(21) Appl. No.: **29/346,272**

(22) Filed: **Oct. 29, 2009**

(30) **Foreign Application Priority Data**

May 4, 2009 (EM) 001133607-0002

(51) **LOC (9) Cl.** **23-01**

(52) **U.S. Cl.** **D23/225**

(58) **Field of Classification Search** D23/213,
D23/202, 225; 239/152-154, 146; D8/2
See application file for complete search history.

(56) **References Cited**

U.S. PATENT DOCUMENTS

D181,095 S * 10/1957 Geary D8/2

D200,473 S * 3/1965 Sawyer D23/225

5,240,186 A * 8/1993 Dobbins et al. 239/690.1

6,688,538 B2 * 2/2004 Nemoto et al. 239/152

6,729,558 B1 * 5/2004 Seenauth 239/152

6,769,628 B1 * 8/2004 Vaage et al. 239/152

7,619,813 B2 * 11/2009 Maeda et al. 359/341.42

* cited by examiner

Primary Examiner—Robin V Webster

(74) *Attorney, Agent, or Firm*—McGuireWoods LLP

(57) **CLAIM**

I claim the ornamental design for a sprayer, as shown and described.

DESCRIPTION

FIG. 1 is a right side perspective view of the sprayer;
FIG. 2 is a rear view of the sprayer shown in FIG. 1;
FIG. 3 is a front view of the sprayer shown in FIG. 1;
FIG. 4 is a top view of the sprayer shown in FIG. 1;
FIG. 5 is a bottom view of the sprayer shown in FIG. 1;
FIG. 6 is a right side view of the sprayer shown in FIG. 1; and,
FIG. 7 is a left side view of the sprayer shown in FIG. 1.

1 Claim, 7 Drawing Sheets

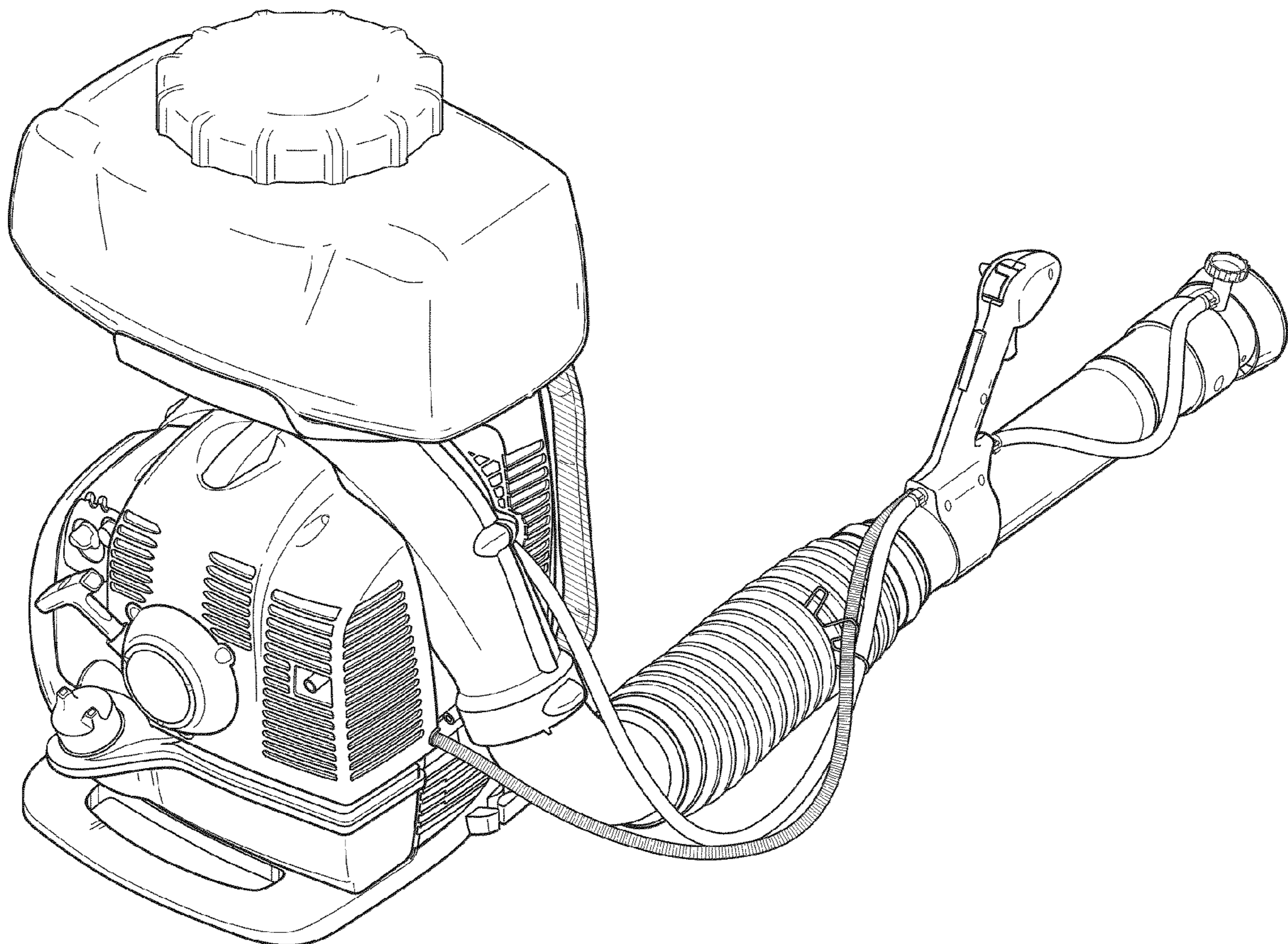

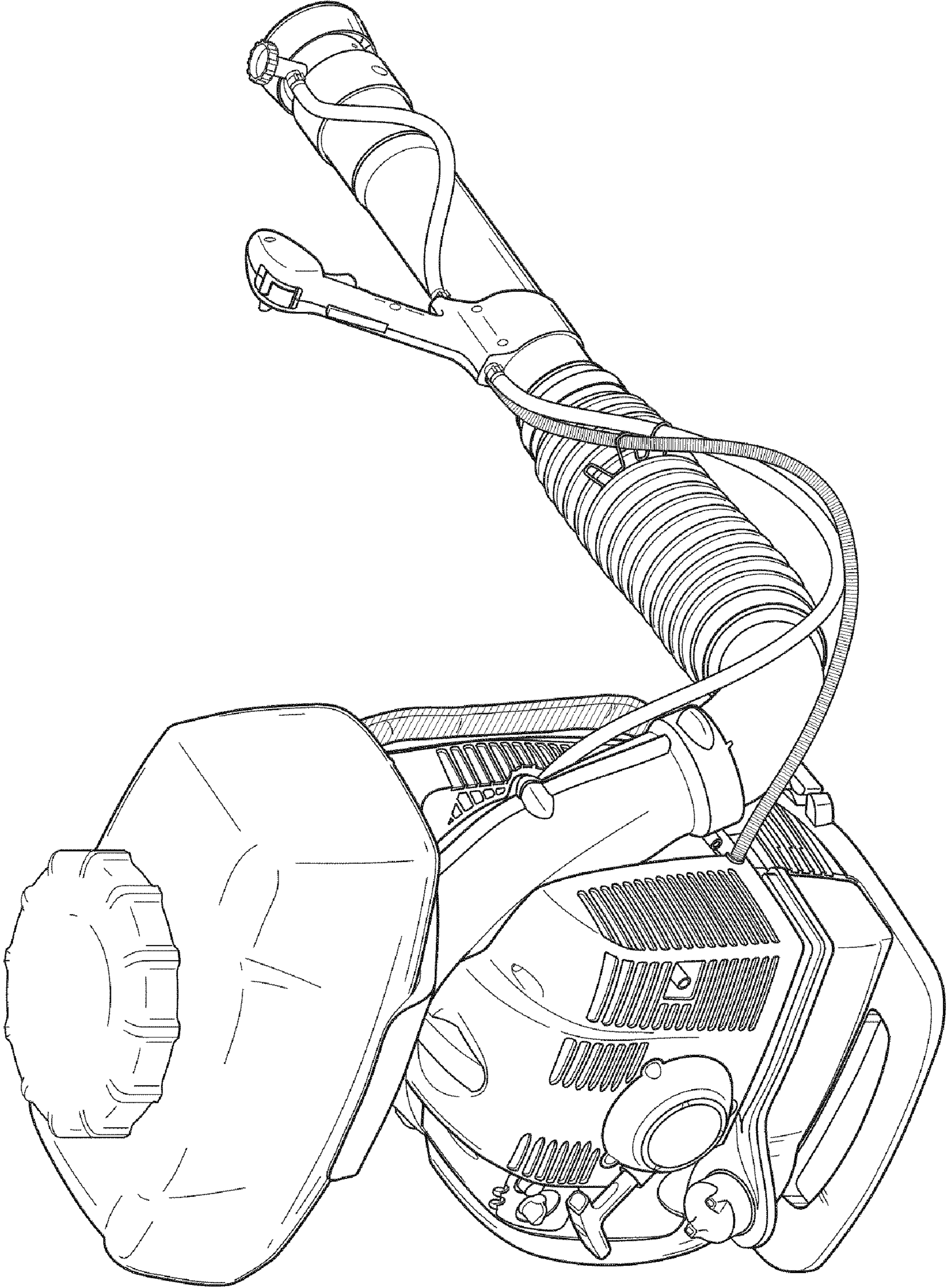

FIG. 1

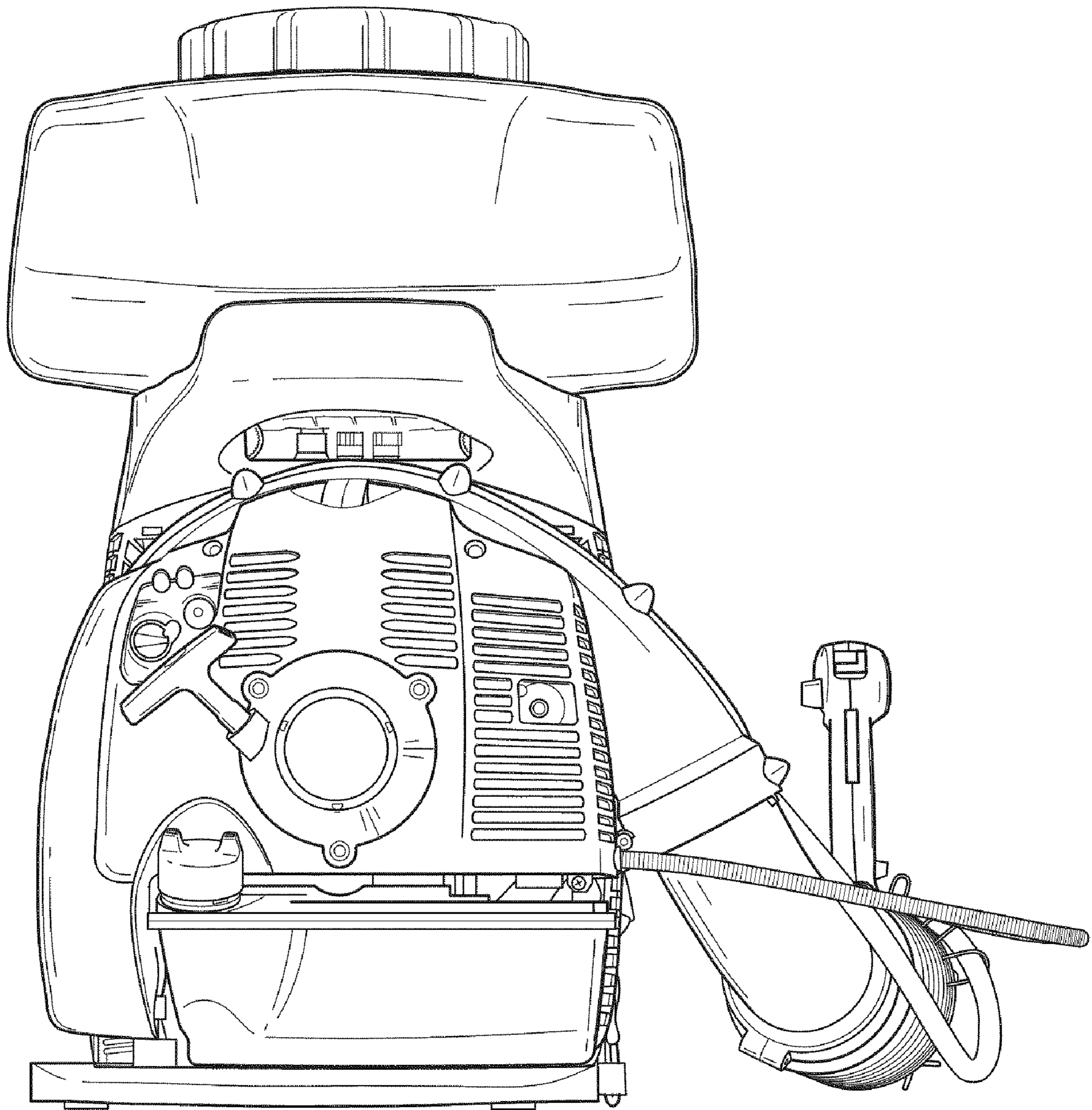

FIG. 2

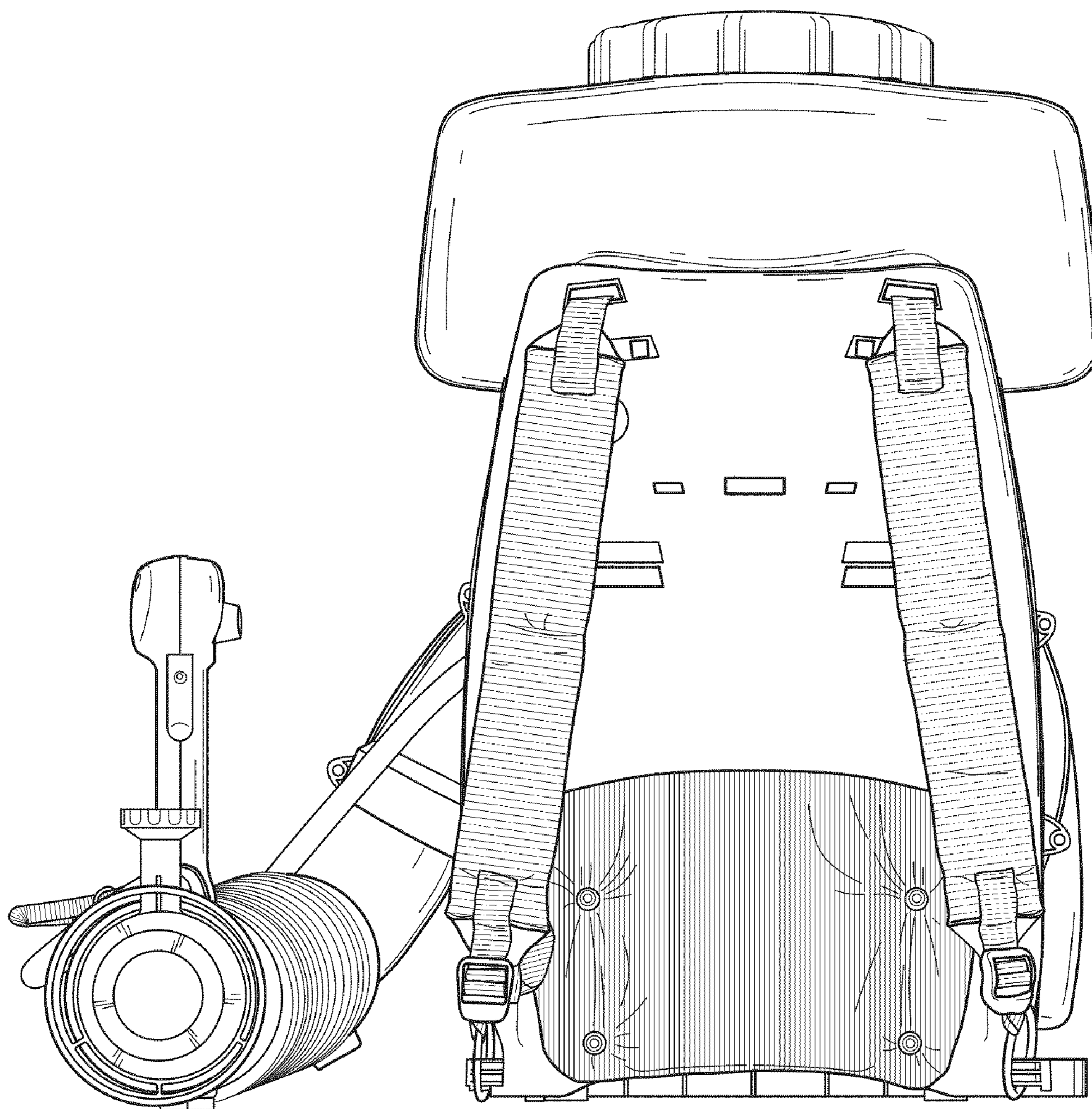

FIG. 3

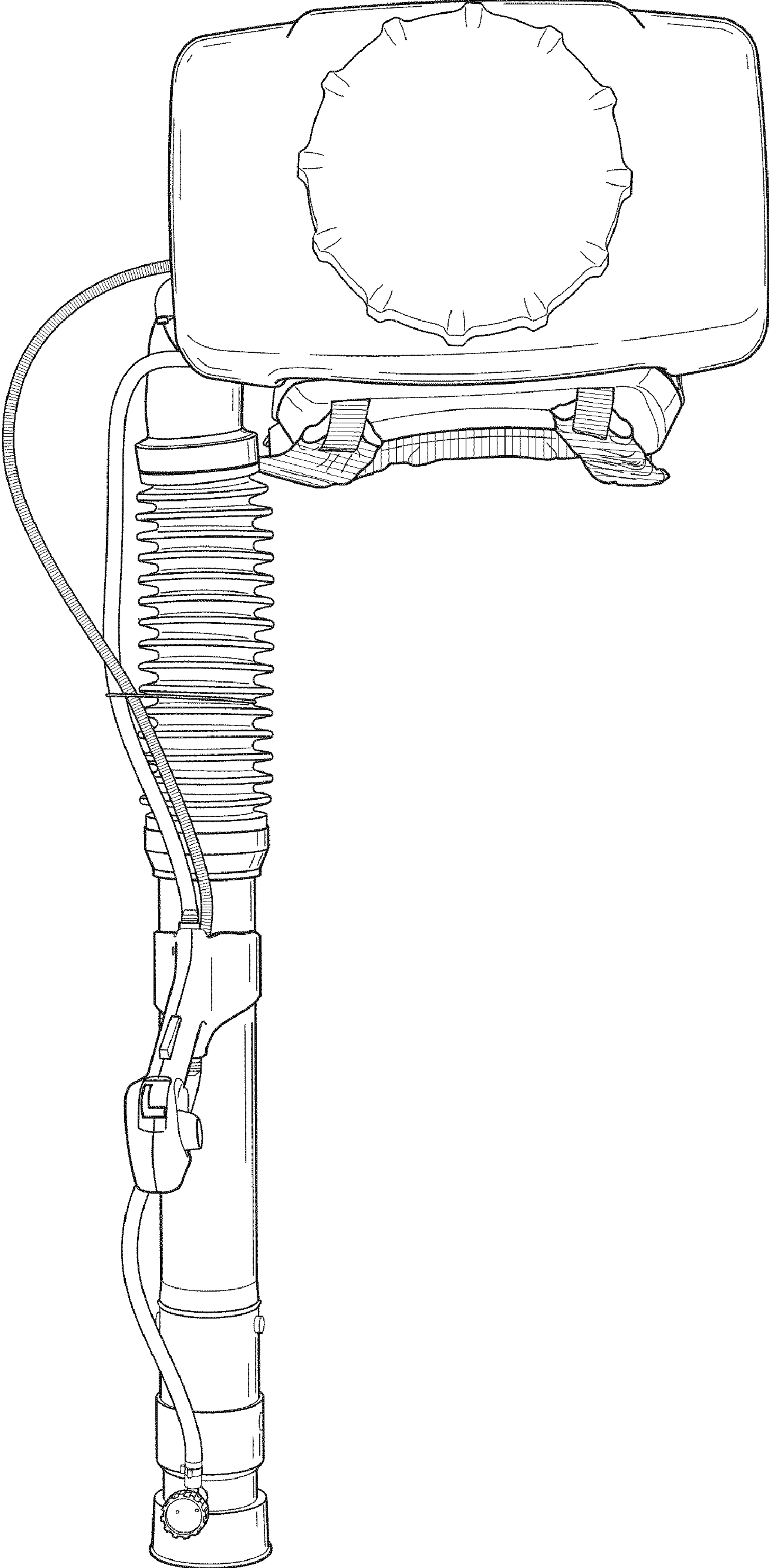

FIG. 4

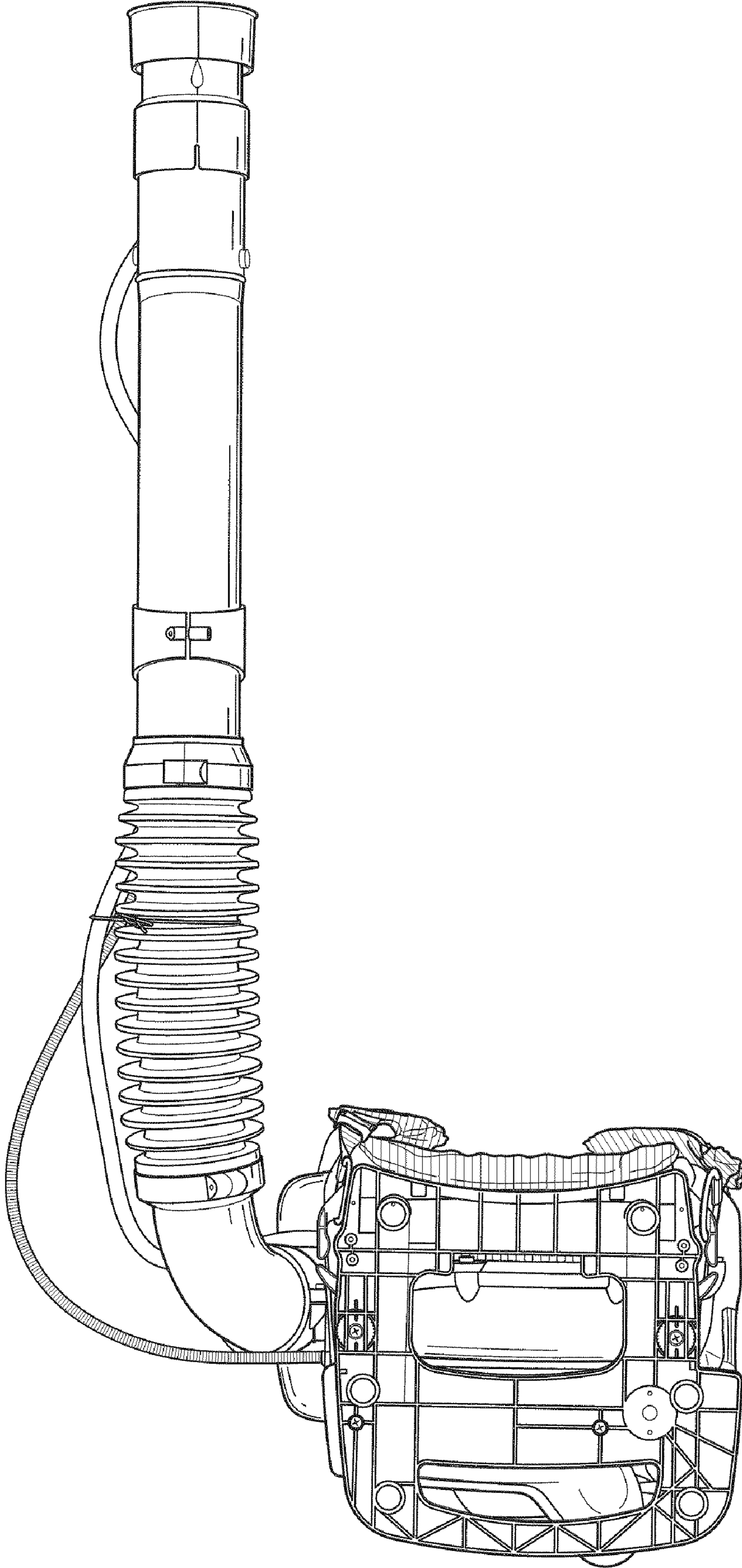

FIG. 5

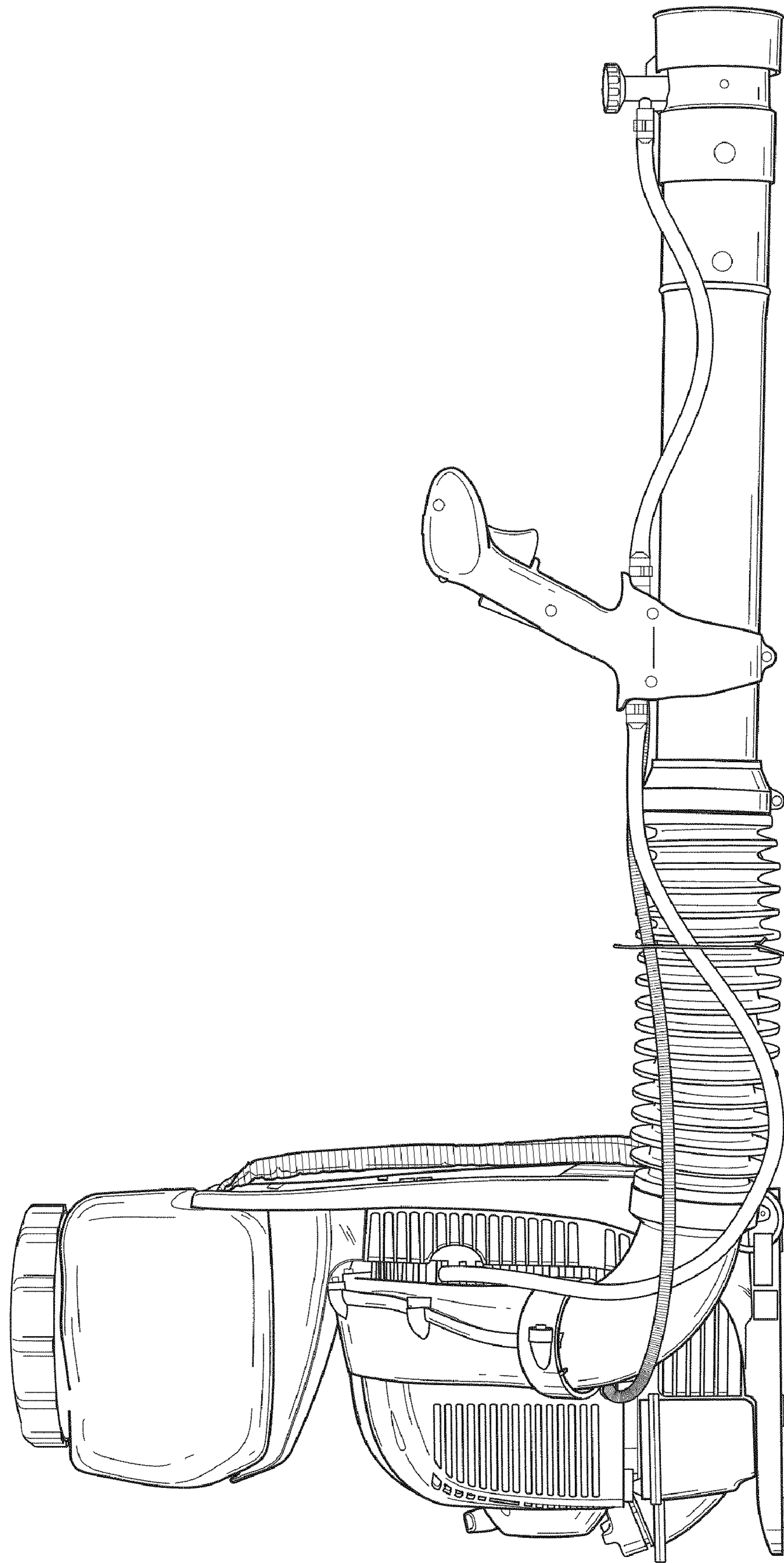

FIG. 6

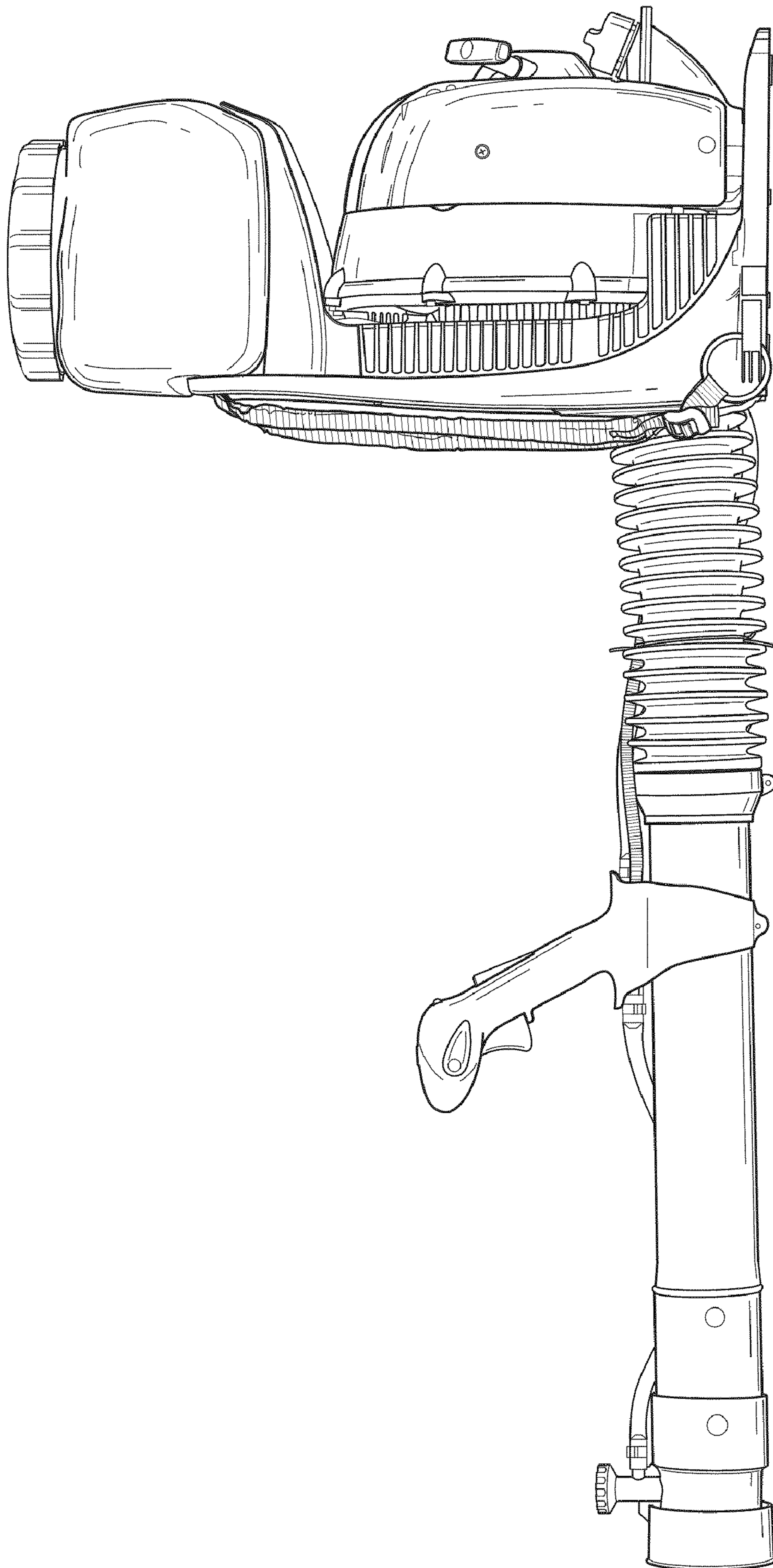

FIG. 7