



US00D623615S

(12) **United States Design Patent**
Kuramashi et al.

(10) **Patent No.:** **US D623,615 S**
(45) **Date of Patent:** **** Sep. 14, 2010**

(54) **TELEVISION RECEIVER**

(75) Inventors: **Yu Kuramashi**, Kanagawa-ken (JP);
Hideto Shimizu, Tokyo (JP); **Tatsuya**
Honda, Kanagawa-ken (JP)

(73) Assignee: **Kabushiki Kaisha Toshiba** (JP)

(**) Term: **14 Years**

(21) Appl. No.: **29/325,257**

(22) Filed: **Sep. 29, 2008**

(30) **Foreign Application Priority Data**

Jul. 16, 2008 (JP) 2008-018366

(51) **LOC (9) Cl.** **14-03**

(52) **U.S. Cl.** **D14/126**

(58) **Field of Classification Search** D14/125-134,
D14/239, 371, 136, 374-377, 440, 450, 448,
D14/336, 342; 312/7.2; 348/836, 838, 180,
348/184, 325, 739; 341/12; 248/917-924,
248/465; 345/104, 133, 156, 168, 87, 173;
720/605, 669, 600, 655; 369/99, 197; 455/344,
455/347; D21/329, 515, 577, 622, 333, 433,
D21/448, 452, 450, 331; D6/477, 479, 300;
273/148 B; 446/484, 175, 356; D10/15,
D10/26

See application file for complete search history.

(56) **References Cited**

U.S. PATENT DOCUMENTS

D505,403 S * 5/2005 Kita D14/126
D532,759 S * 11/2006 Park D14/126

D557,227 S * 12/2007 Isshiki D14/126
D563,916 S * 3/2008 Shimizu et al. D14/126
D565,518 S * 4/2008 Tu D14/126
D576,122 S * 9/2008 Suzuki et al. D14/126
D580,896 S * 11/2008 Niitsu D14/126
D587,665 S * 3/2009 Isshiki D14/126
D607,426 S * 1/2010 Yang D14/126
D612,820 S * 3/2010 Jeong et al. D14/126

FOREIGN PATENT DOCUMENTS

JP D1263132 2/2006
JP D1301312 5/2007

* cited by examiner

Primary Examiner—Raphael Barkai

(74) *Attorney, Agent, or Firm*—Banner & Witcoff, Ltd.

(57) **CLAIM**

The ornamental design for a television receiver, as shown and described.

DESCRIPTION

FIG. 1 is a top, front and right side perspective view of a television receiver showing our new design,

FIG. 2 is a front elevational view thereof,

FIG. 3 is a top plan view thereof,

FIG. 4 is a left side elevational view thereof,

FIG. 5 is a right side elevational view thereof,

FIG. 6 is a bottom plan view thereof,

FIG. 7 is a rear elevational view thereof; and,

FIG. 8 is an enlarged view of the portion labeled 8 in FIG. 2.

1 Claim, 3 Drawing Sheets

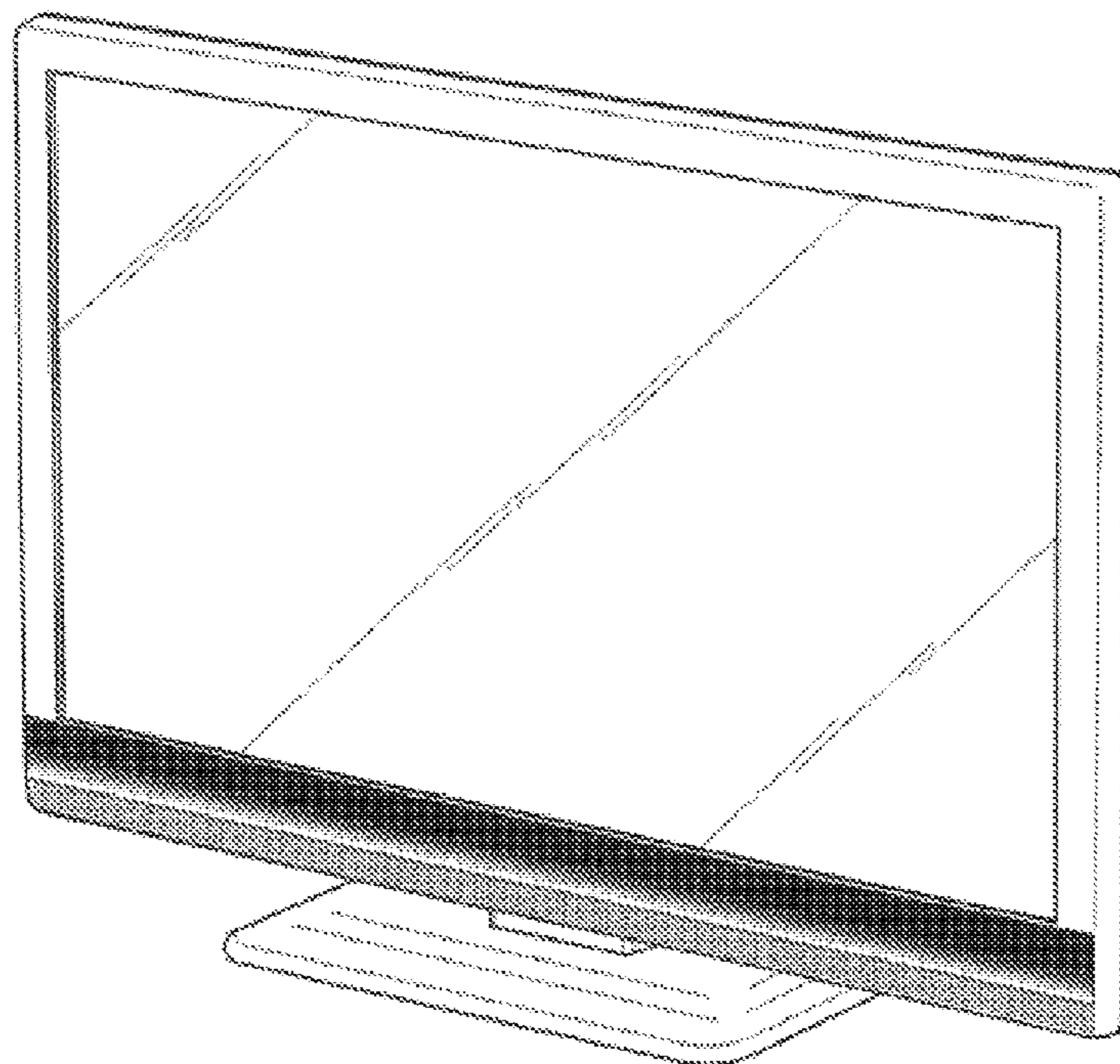

FIG. 1

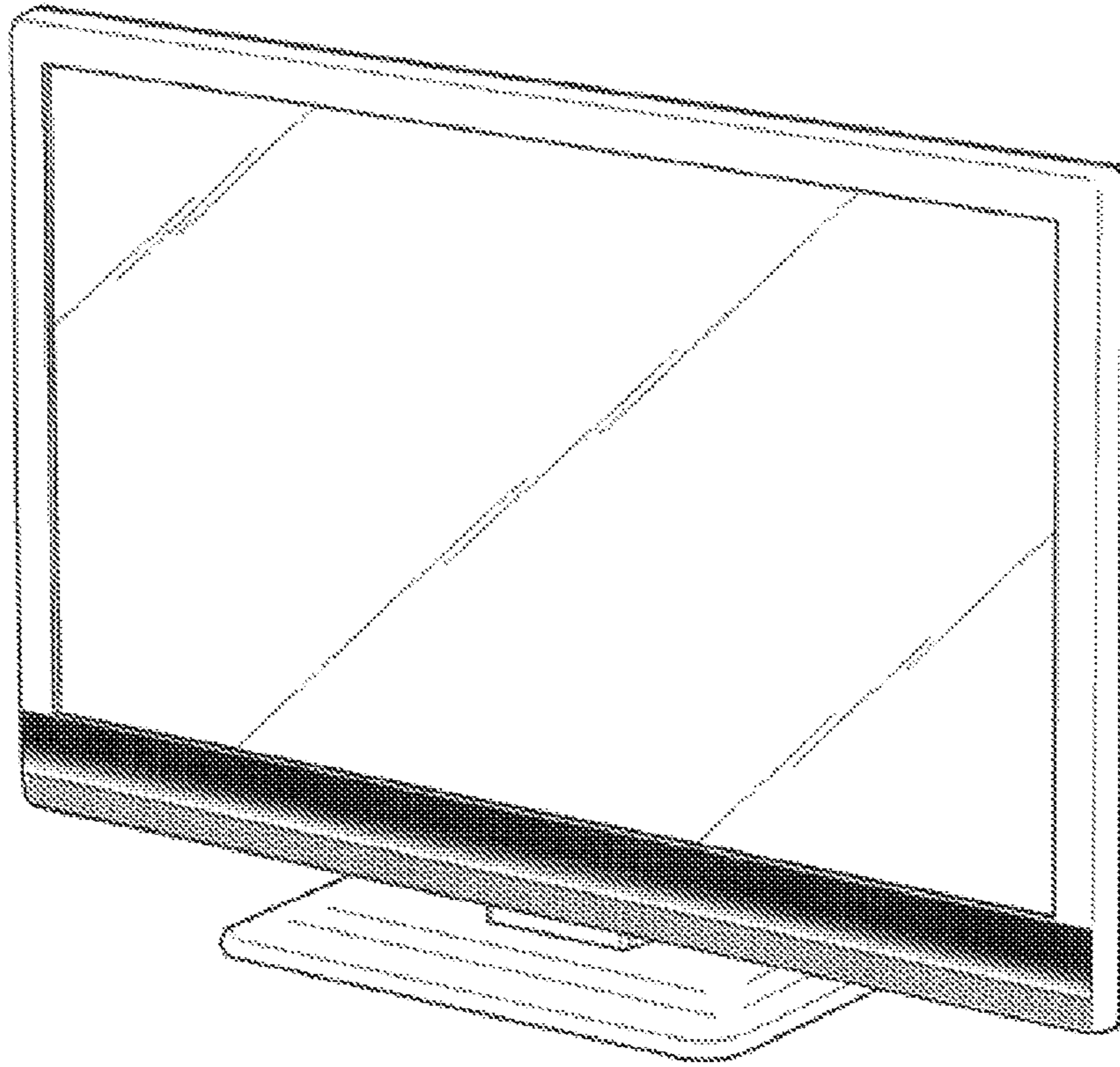

FIG. 2

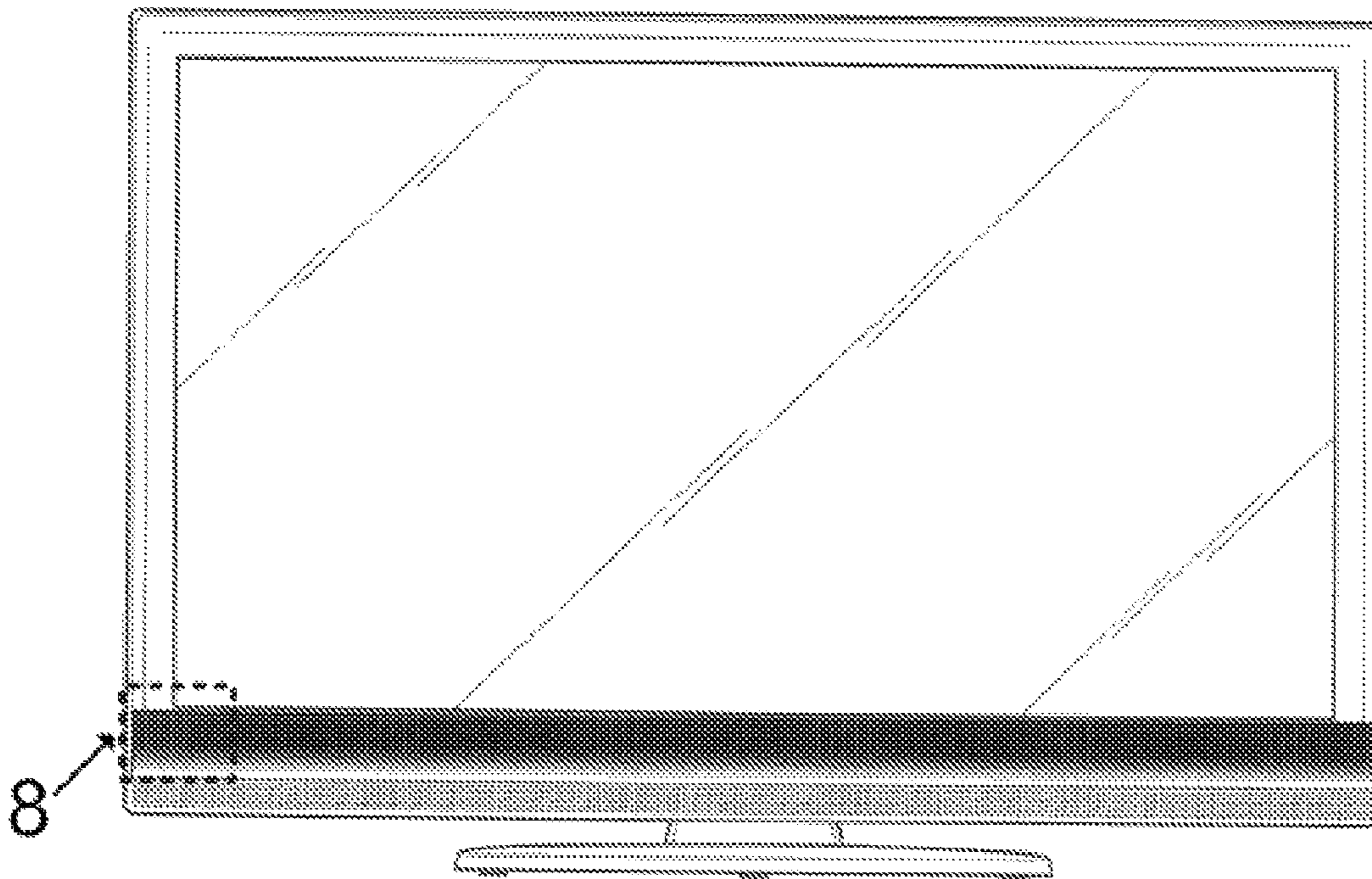

FIG. 3

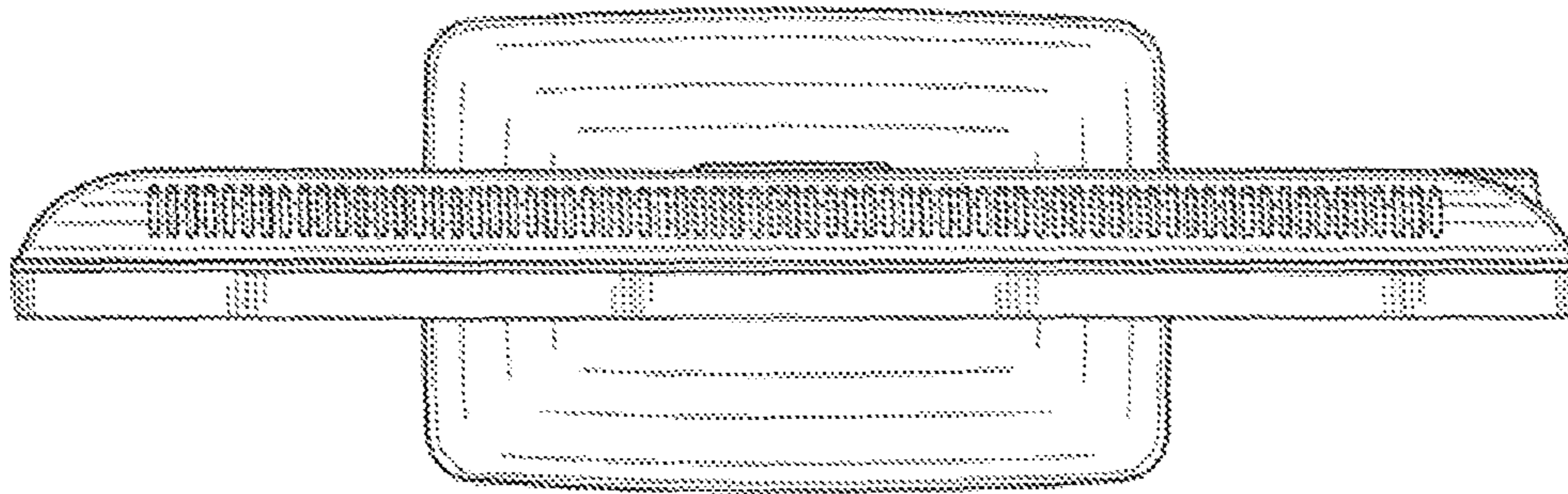

FIG. 4

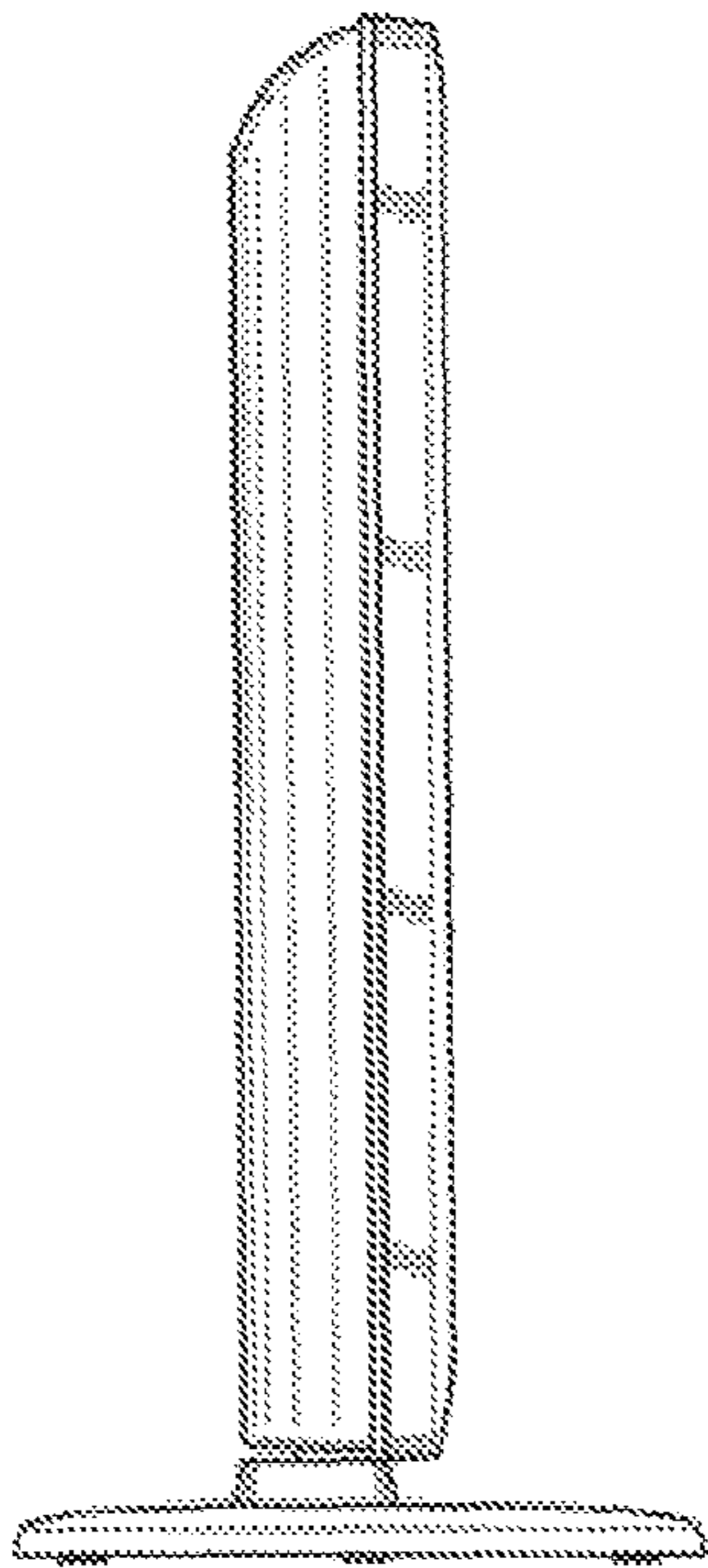

FIG. 5

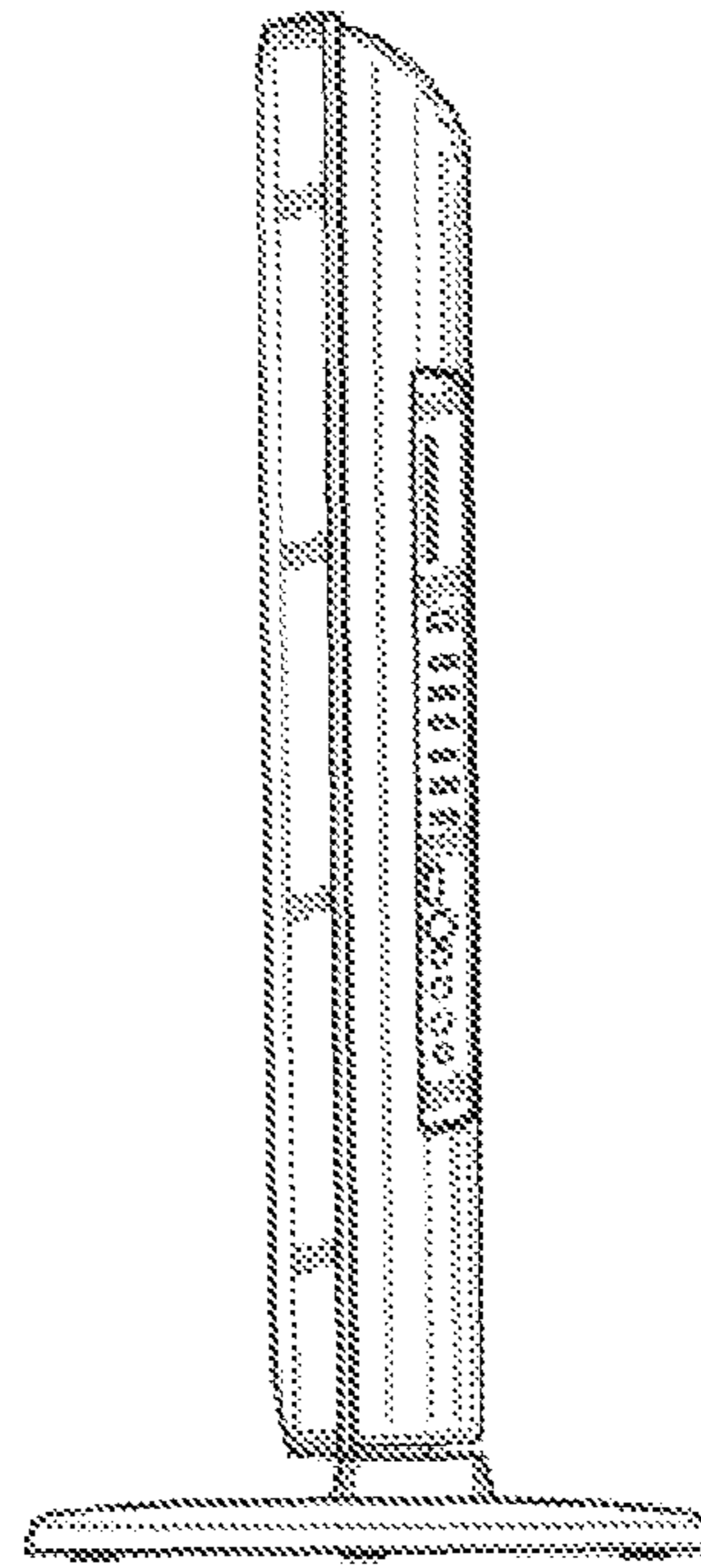

FIG. 6

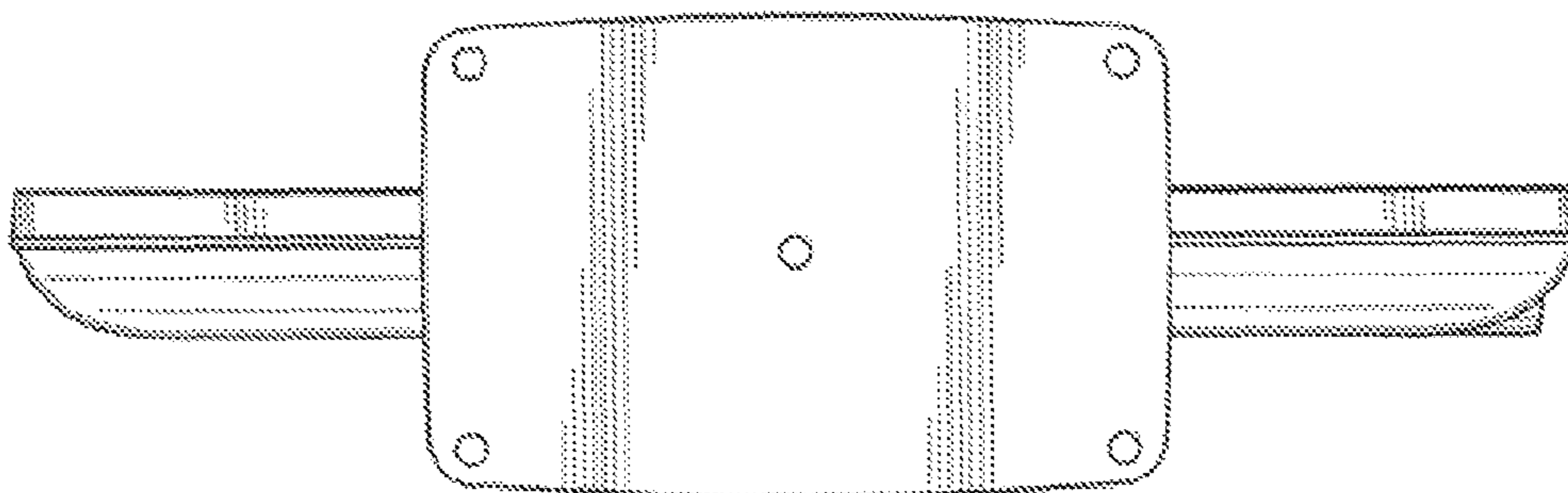

FIG. 7

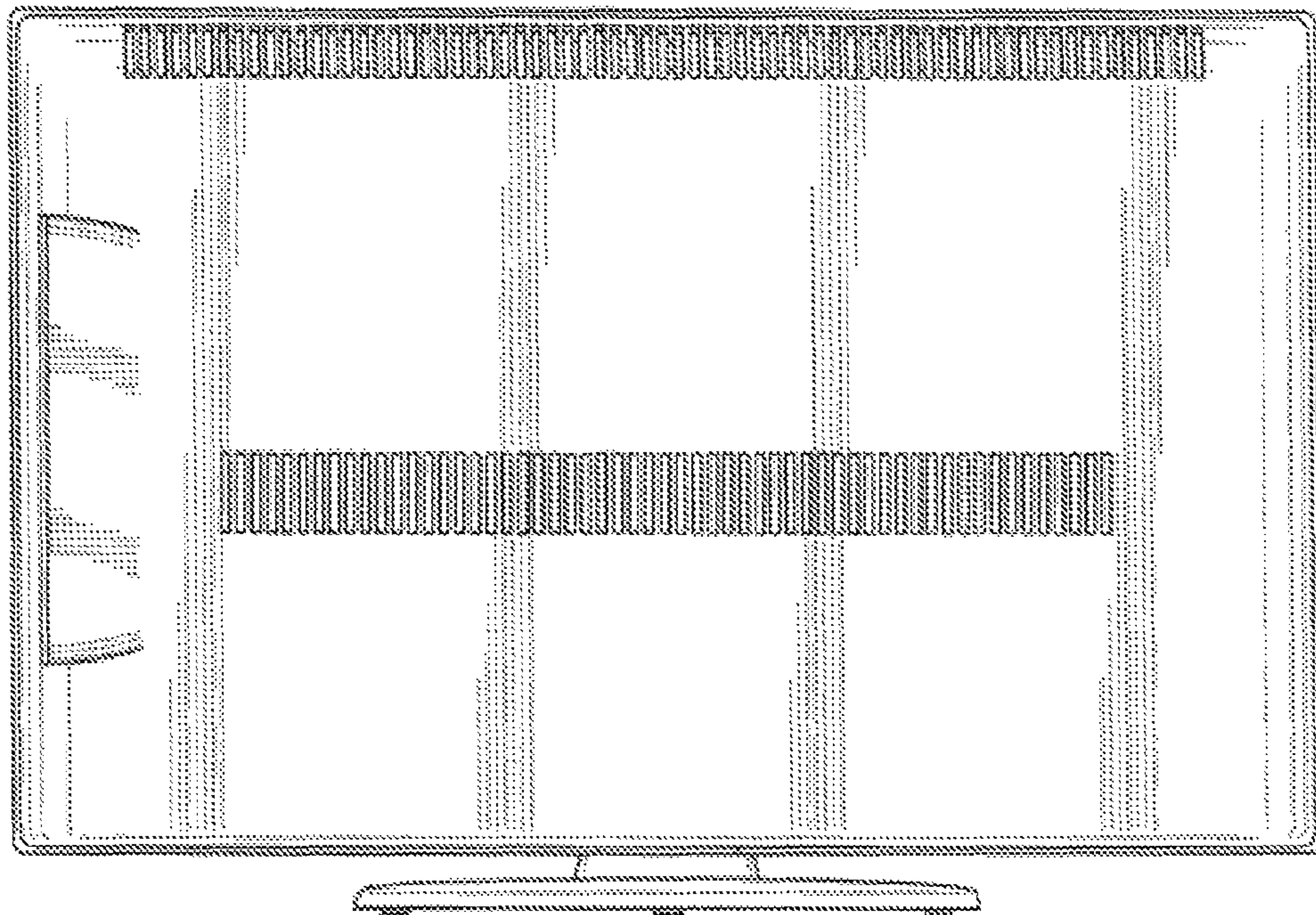

FIG. 8

