



US00D623295S

(12) **United States Design Patent**
Rhoades et al.

(10) **Patent No.:** **US D623,295 S**
(45) **Date of Patent:** **** Sep. 7, 2010**

(54) **HANDHELD SKIN CARE TOOL**

(75) Inventors: **Dean Rhoades**, Beverly Hills, CA (US);
Robert Radi, Los Angeles, CA (US);
Kimber Maderazzo, Pacific Palisades,
CA (US)

(73) Assignee: **Guthy-Renker LLC**, Santa Monica, CA
(US)

(**) Term: **14 Years**

(21) Appl. No.: **29/346,592**

(22) Filed: **Nov. 3, 2009**

Related U.S. Application Data

(62) Division of application No. 29/289,072, filed on Jul. 5,
2007, now Pat. No. Des. 608,002.

(51) **LOC (9) Cl.** **24-02**

(52) **U.S. Cl.** **D24/146; D24/133; D24/147**

(58) **Field of Classification Search** **D24/133,**
D24/146-147, 200, 214, 215; D28/57-59,
D28/62; 132/75.6, 76.4; 606/85, 131-133
See application file for complete search history.

(56) **References Cited**

U.S. PATENT DOCUMENTS

3,467,080	A	9/1969	McNair	
D226,043	S *	1/1973	Wolff D24/214
3,968,789	A	7/1976	Simoncini	
D269,377	S *	6/1983	Mackay et al. D24/214
5,662,593	A	9/1997	Tillman et al.	
5,925,002	A	7/1999	Wollman	

(Continued)

Primary Examiner—Ian Simmons

Assistant Examiner—Wan Laymon

(74) *Attorney, Agent, or Firm*—Cislo & Thomas, LLP

(57) **CLAIM**

The ornamental design for a handheld skin care tool, as shown and described.

DESCRIPTION

FIG. 1 is a perspective view of the handheld skin care tool;
FIG. 2 is a top view of the handheld skin care tool shown in
FIG. 1;

FIG. 3 is a bottom view of the handheld skin care tool shown
in FIG. 1;

FIG. 4 is a front view of the handheld skin care tool shown in
FIG. 1;

FIG. 5 is a side view of the handheld skin care tool shown in
FIG. 1;

FIG. 6 is another side view of the handheld skin care tool
shown in FIG. 1;

FIG. 7 is a rear view of the handheld skin care tool shown in
FIG. 1;

FIG. 8 is a perspective view of another embodiment of the
handheld skin care tool;

FIG. 9 is a front view of the handheld skin care tool shown in
FIG. 8;

FIG. 10 is a side view of the handheld skin care tool shown in
FIG. 8;

FIG. 11 is another perspective view of the handheld skin care
tool shown in FIG. 8;

FIG. 12 is a side view of another embodiment of the handheld
skin care tool;

FIG. 13 is another side view of the handheld skin care tool
shown in FIG. 12;

FIG. 14 is top view of the handheld skin care tool shown in
FIG. 12; and,

FIG. 15 is a bottom view of the handheld skin care tool shown
in FIG. 12.

The broken lines in the drawings are for illustrative purposes
only and form no part of the claimed design.

1 Claim, 6 Drawing Sheets

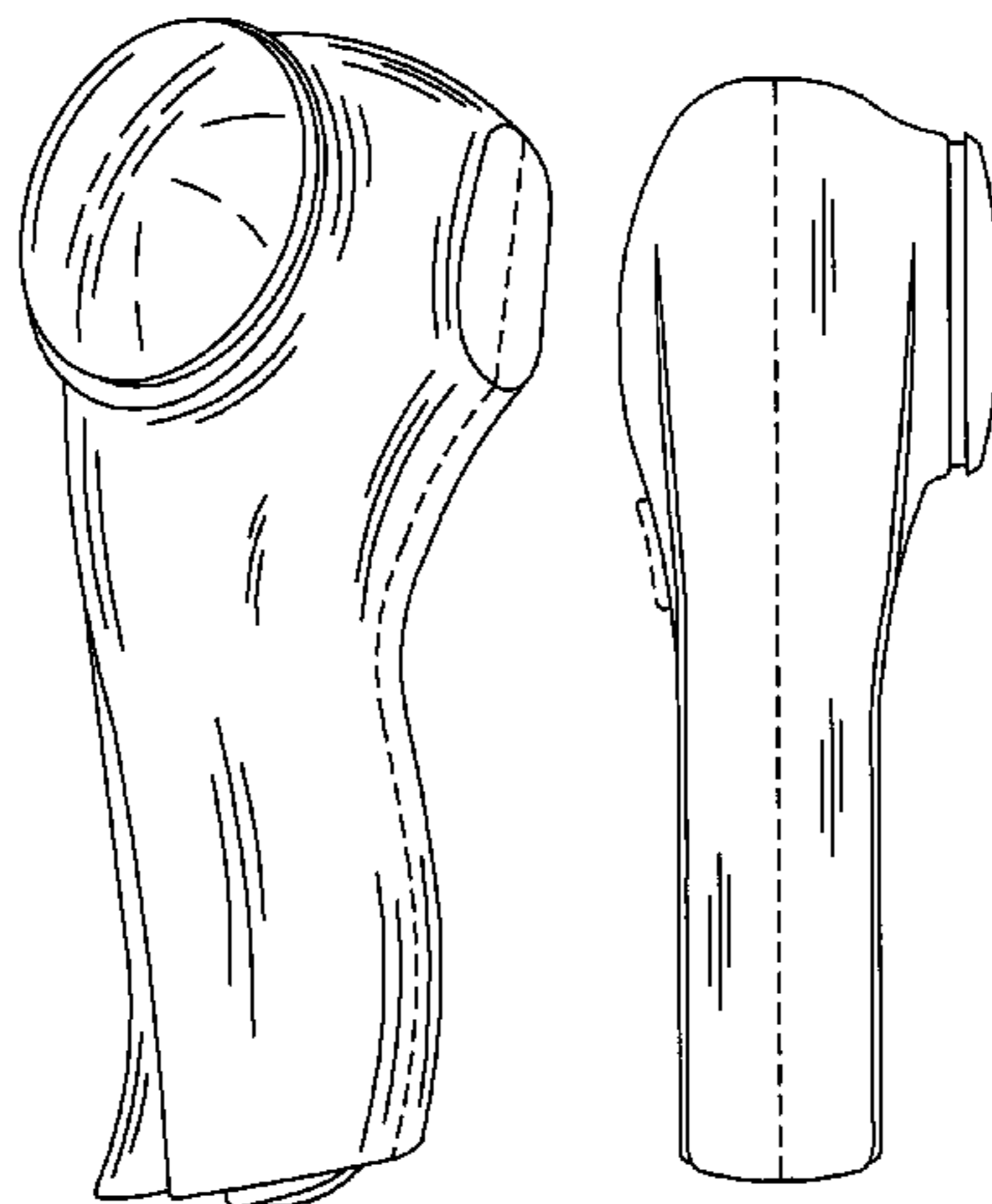

US D623,295 S

Page 2

U.S. PATENT DOCUMENTS

D414,582 S *	9/1999	Hwang	D24/214	D510,138 S *	9/2005	Kim	D24/133
6,312,397 B1 *	11/2001	Gebhard	601/15	D533,943 S *	12/2006	Chen	D24/146
6,652,888 B2 *	11/2003	Rhoades	606/131	D550,842 S *	9/2007	Koch et al.	D24/146
D500,168 S	12/2004	Ho			D561,343 S *	2/2008	Liang	D24/215
D500,854 S *	1/2005	Eichel	D24/146	7,572,238 B2 *	8/2009	Rhoades	601/73
					D608,002 S *	1/2010	Rhoades et al.	D24/146

* cited by examiner

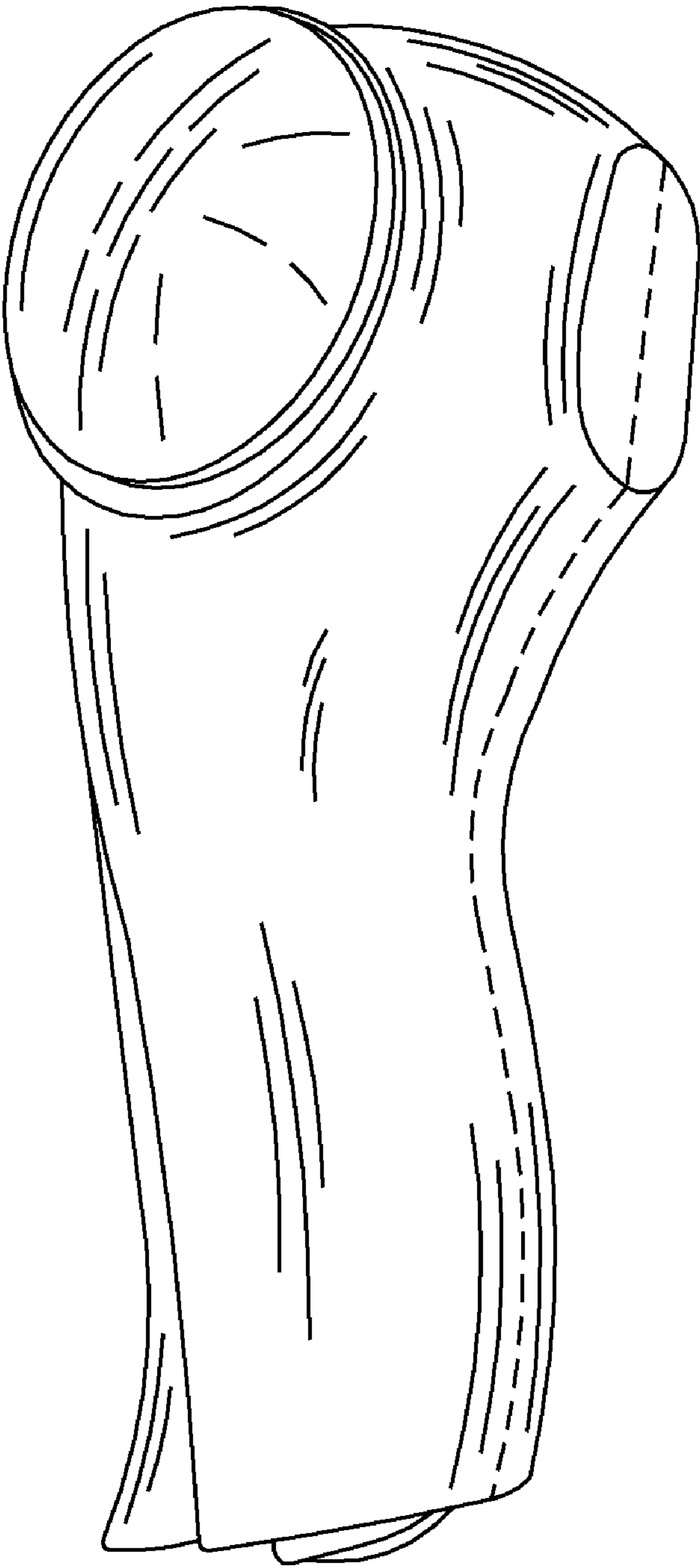

FIG. 1

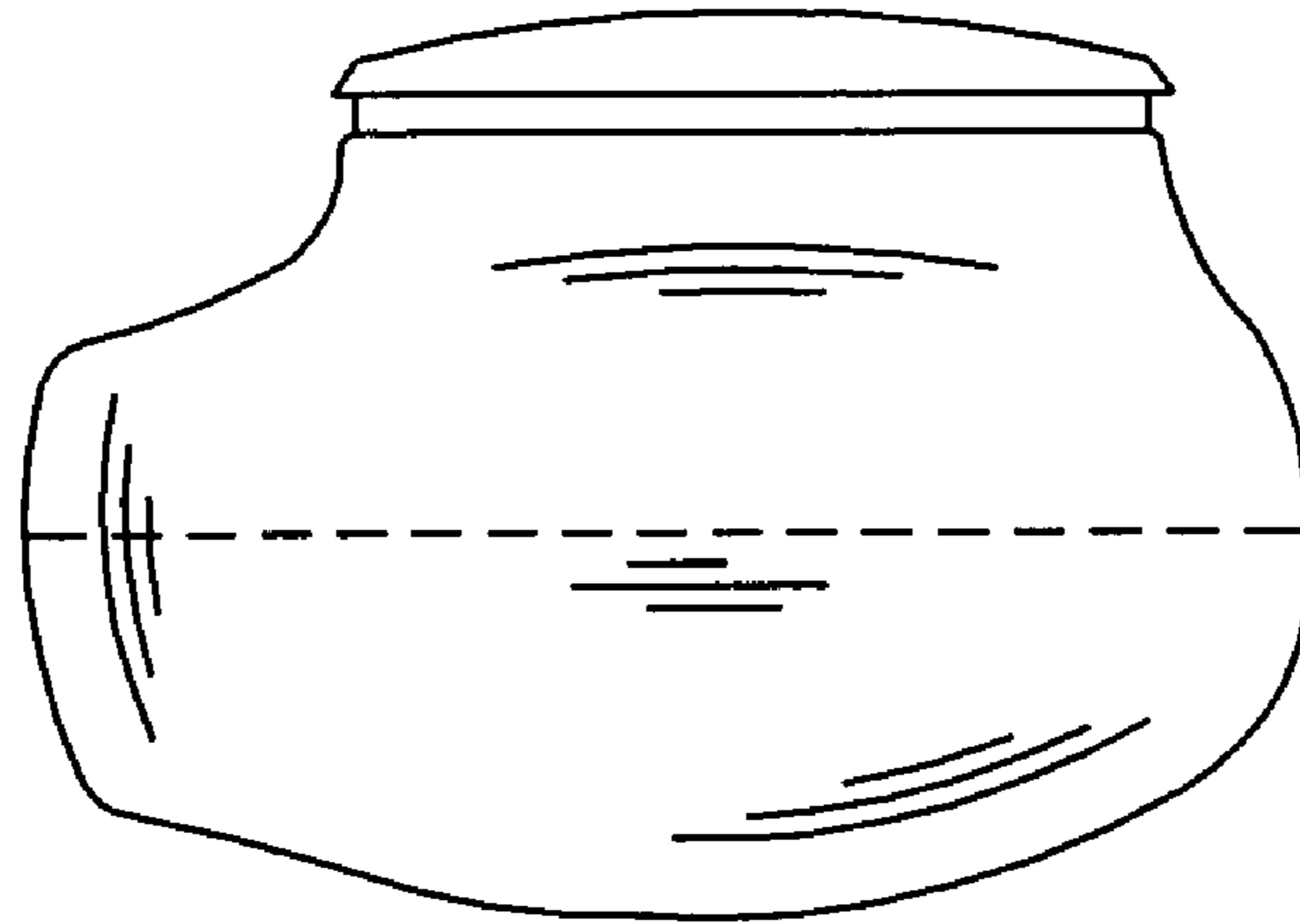

FIG. 2

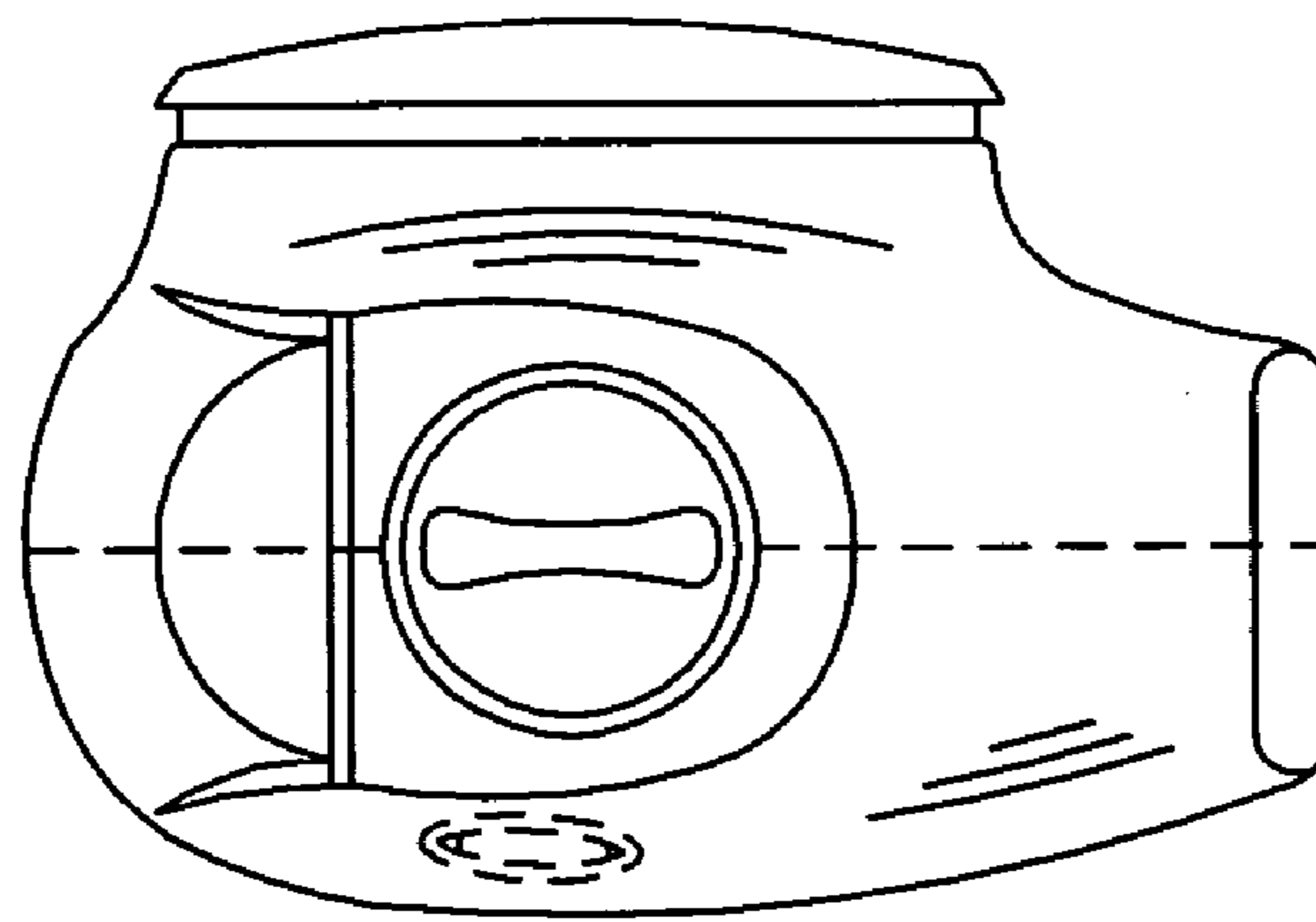

FIG. 3

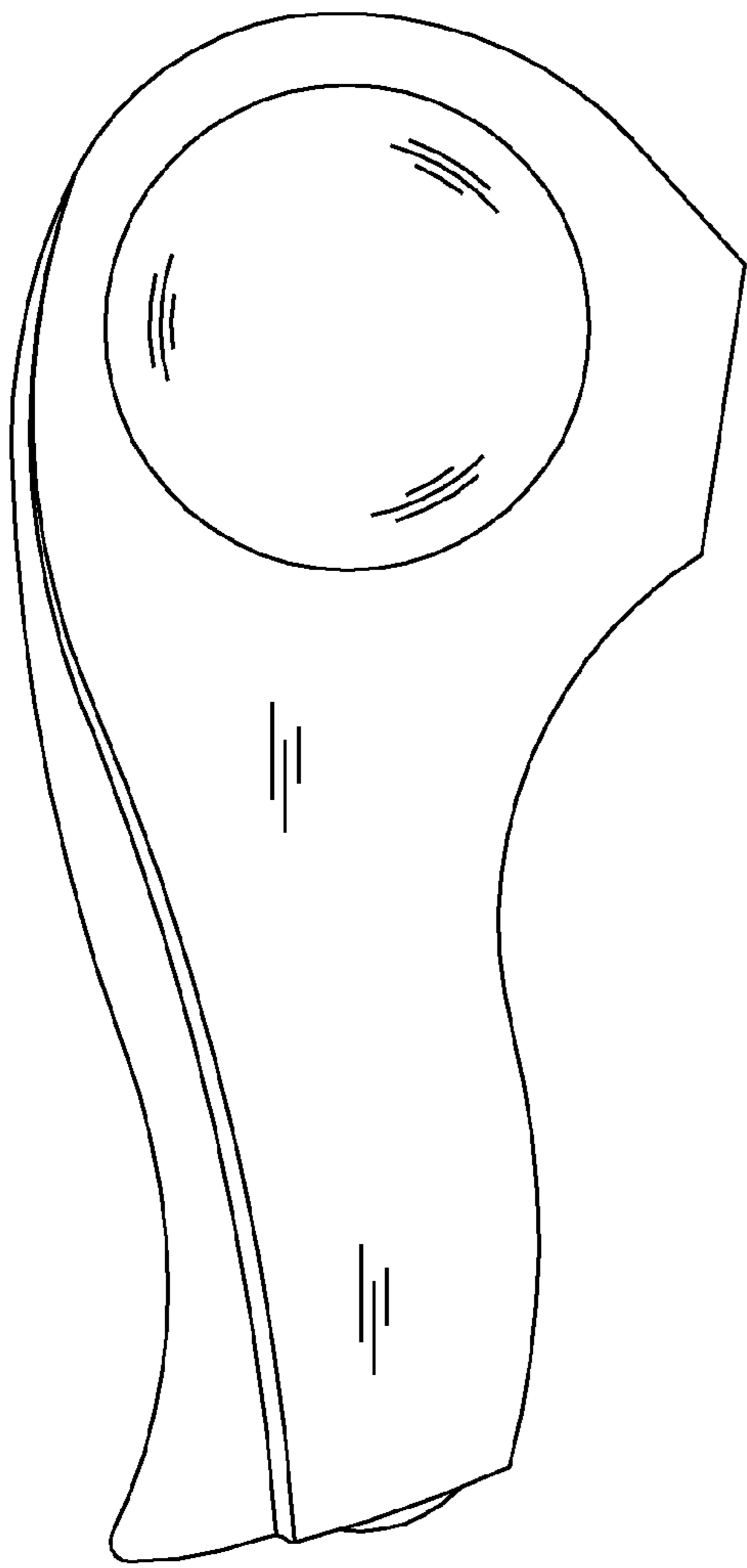

FIG. 4

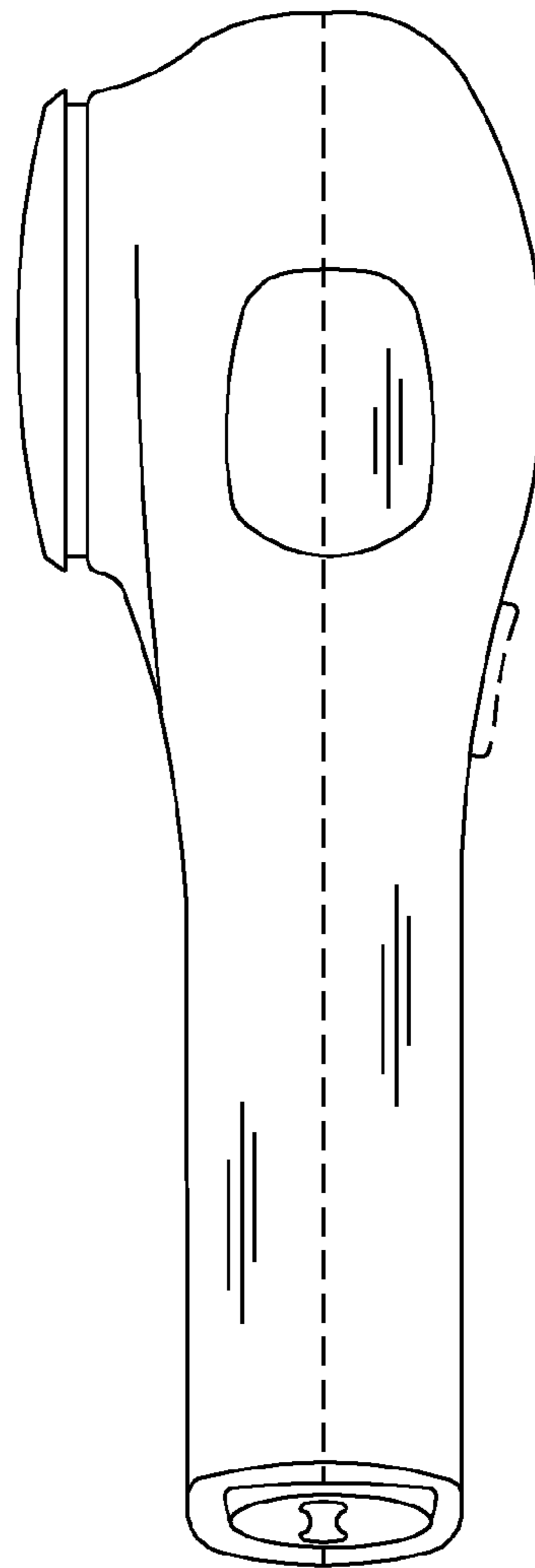

FIG. 5

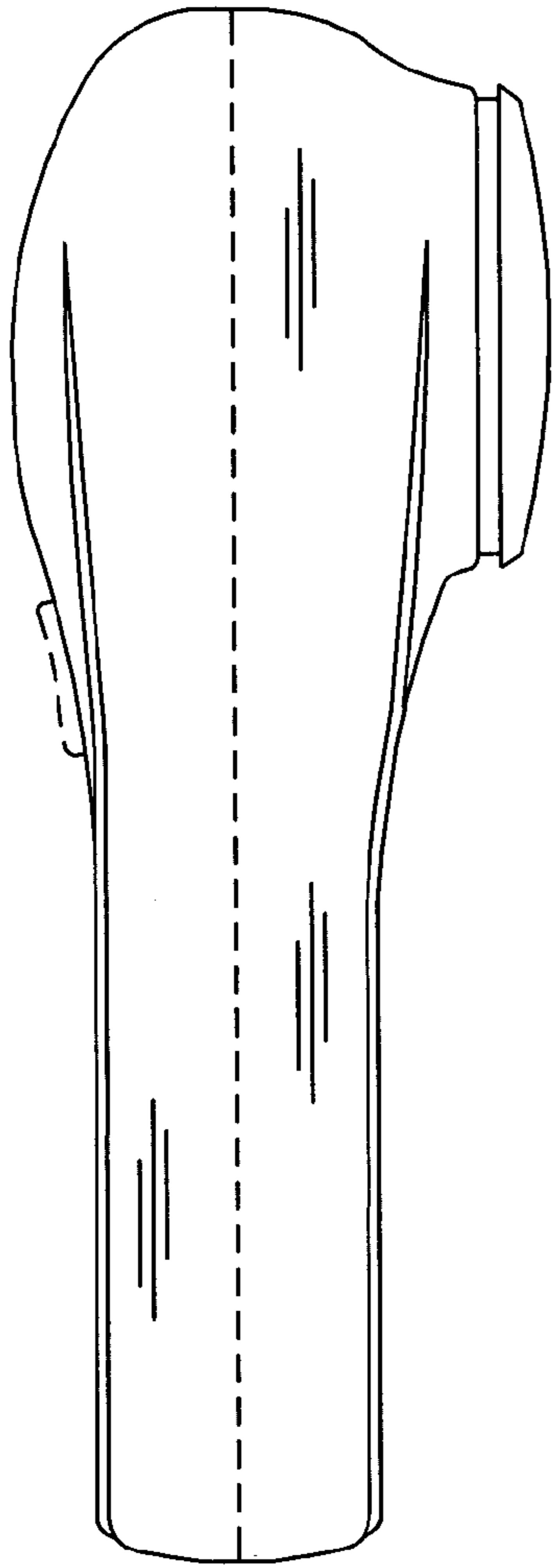

FIG. 6

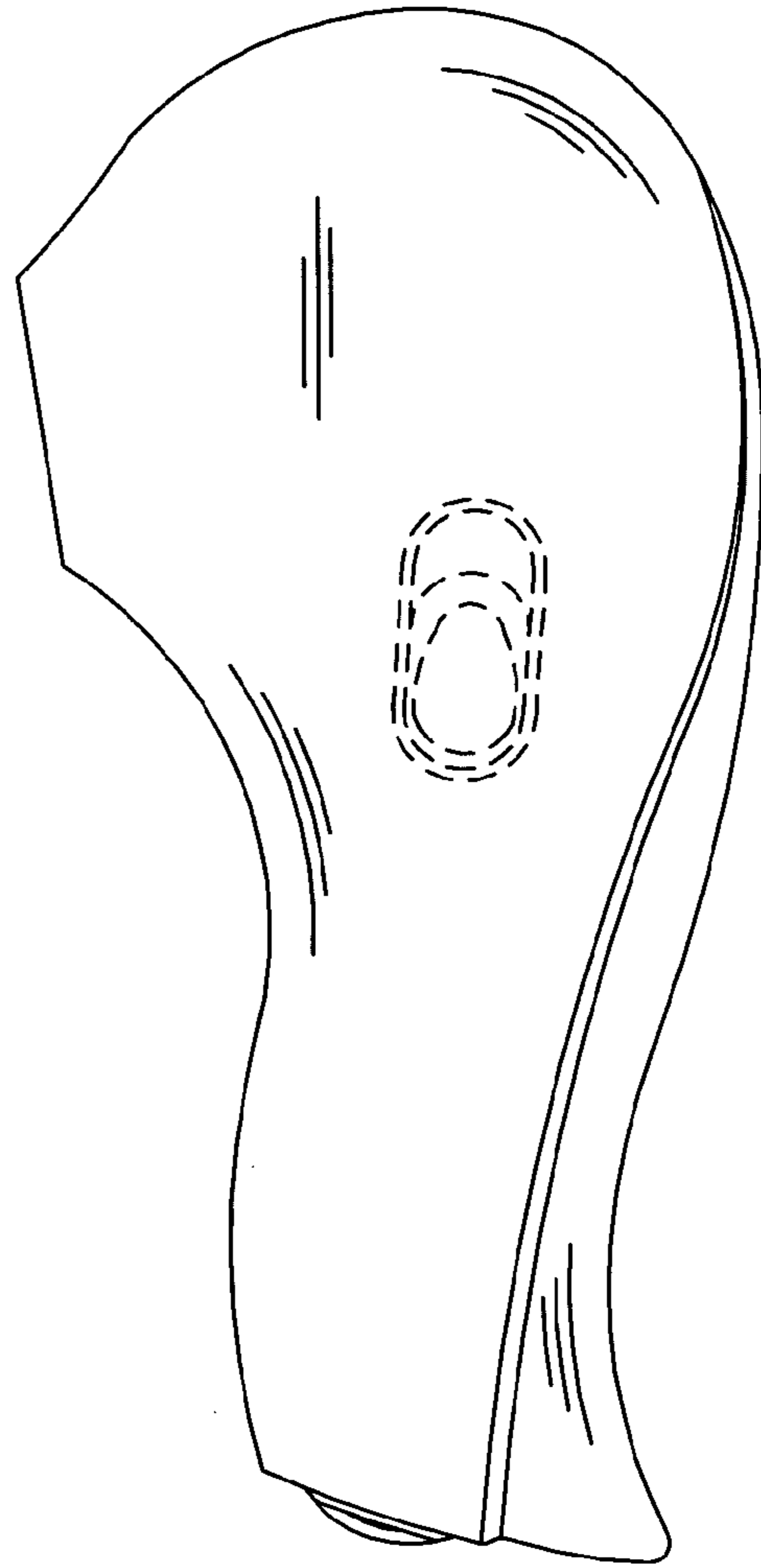

FIG. 7

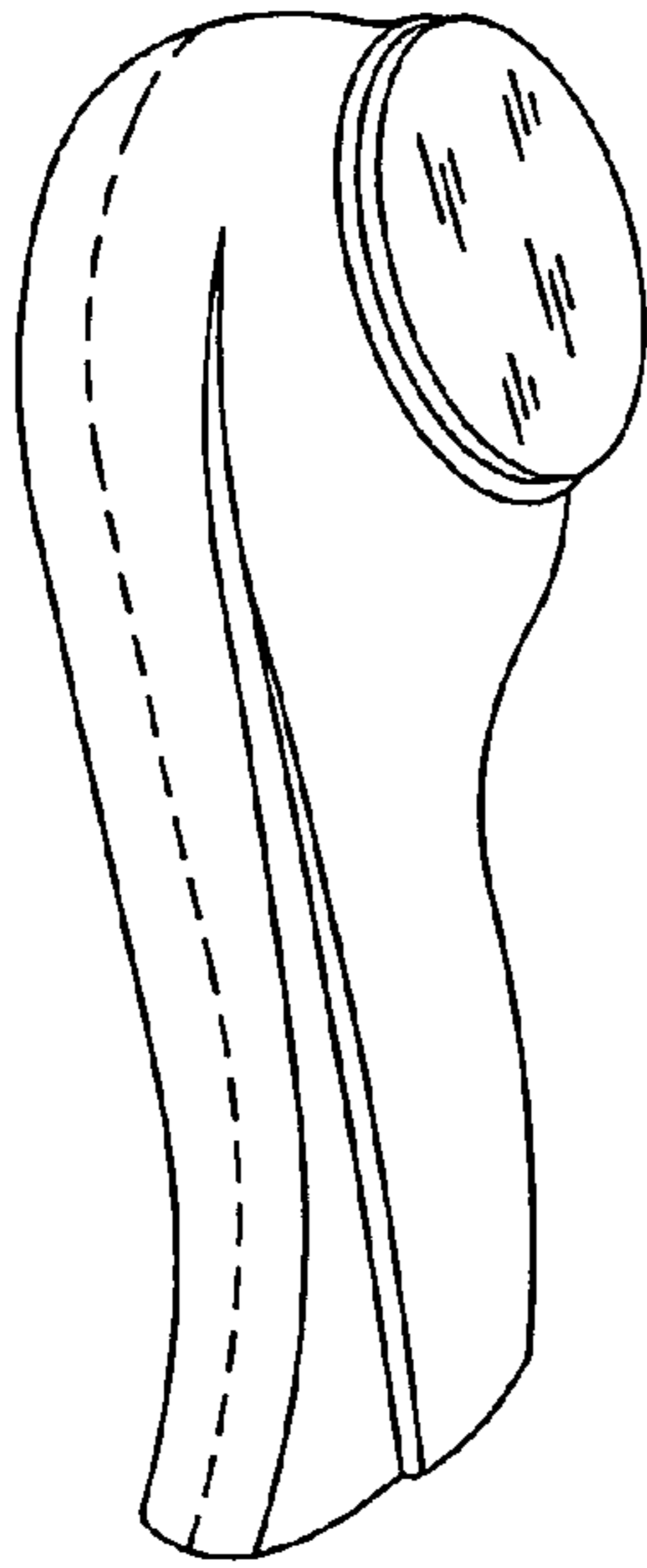

FIG. 8

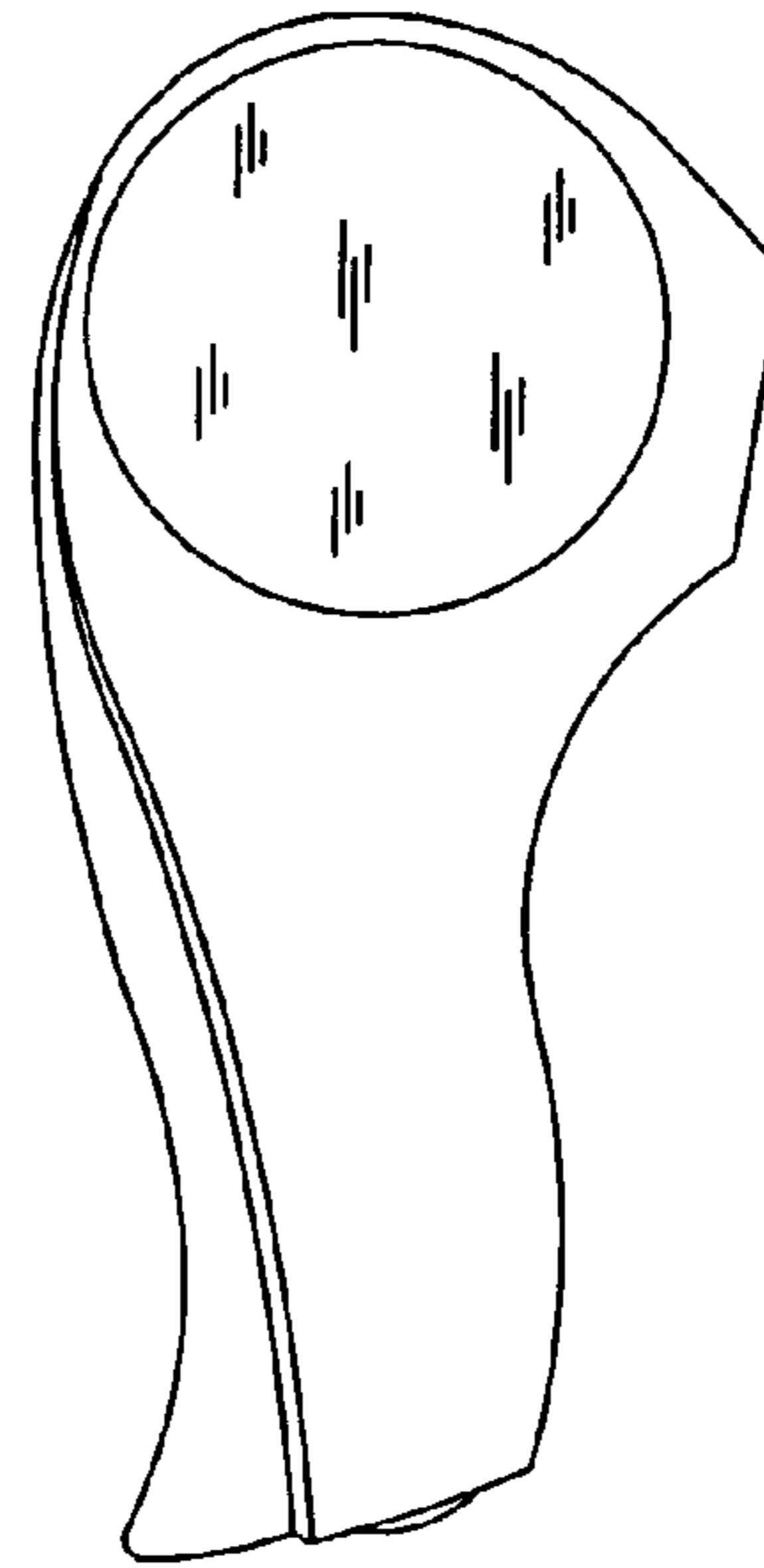

FIG. 9

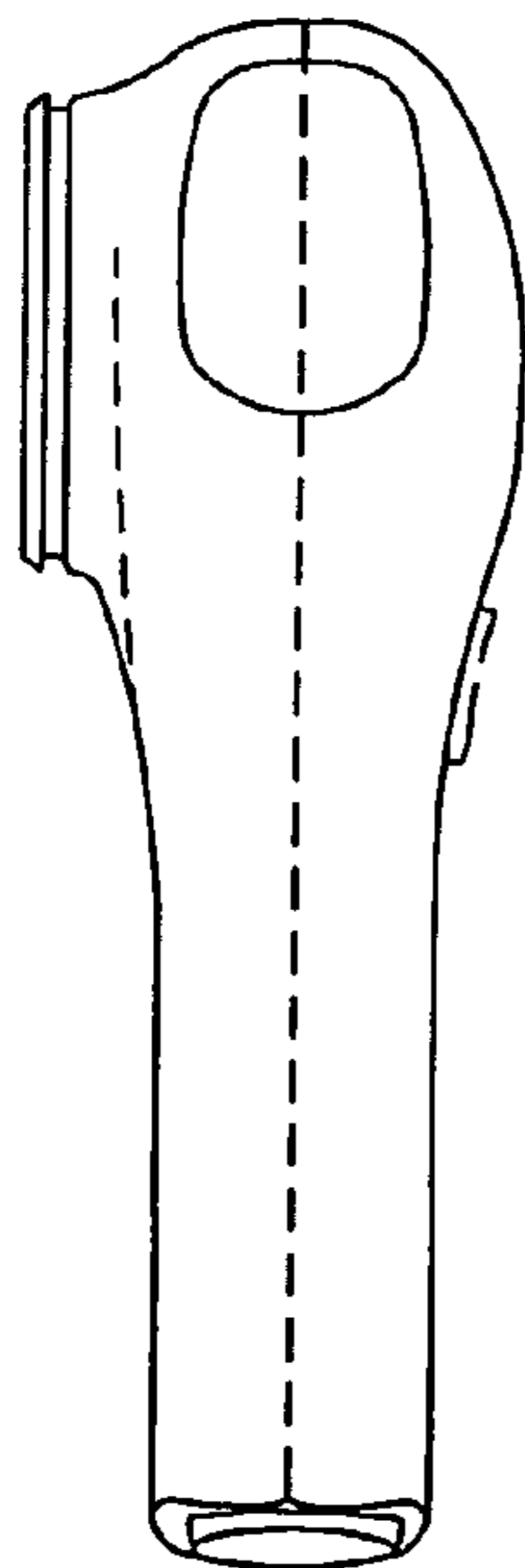

FIG. 10

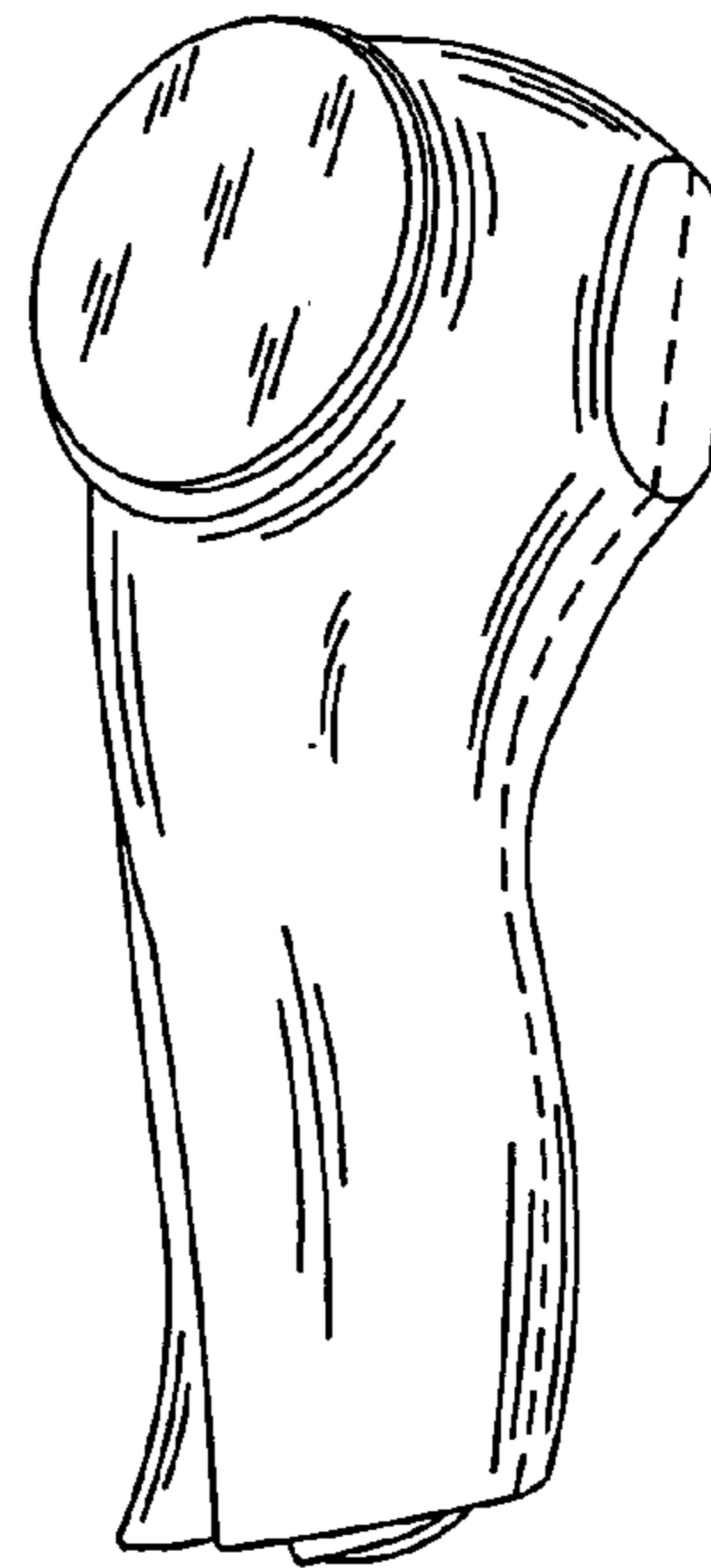

FIG. 11

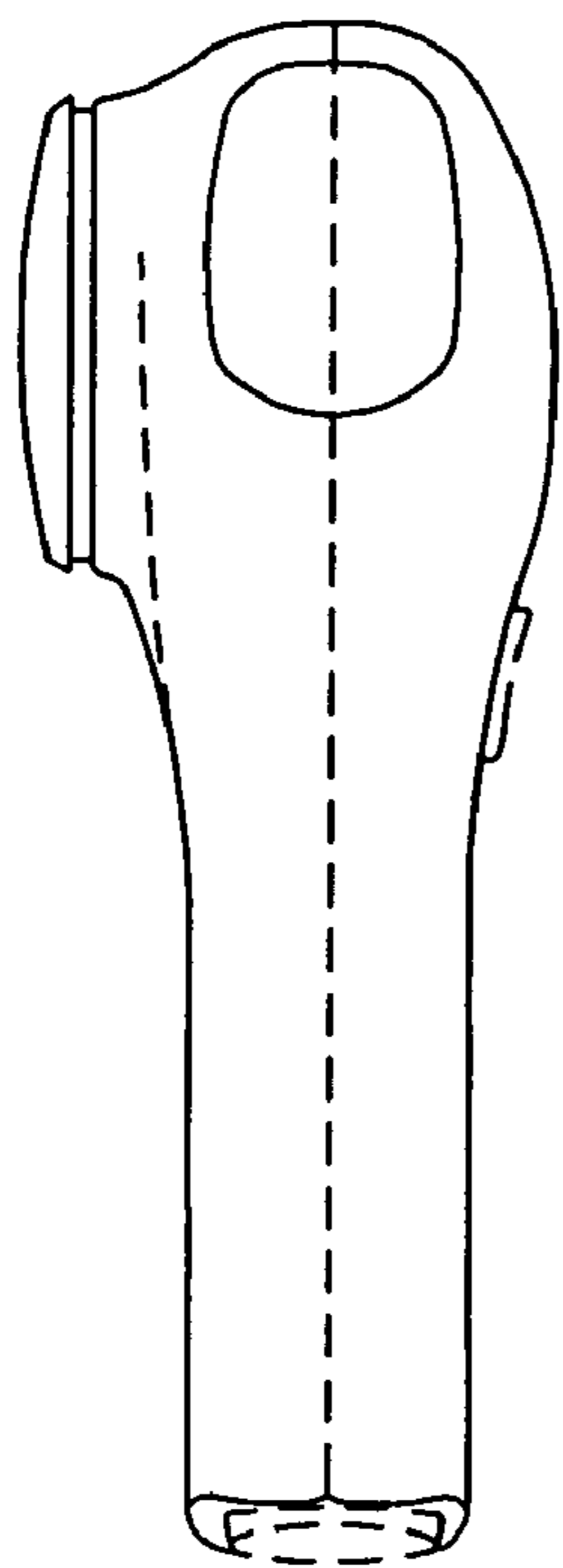

FIG. 12

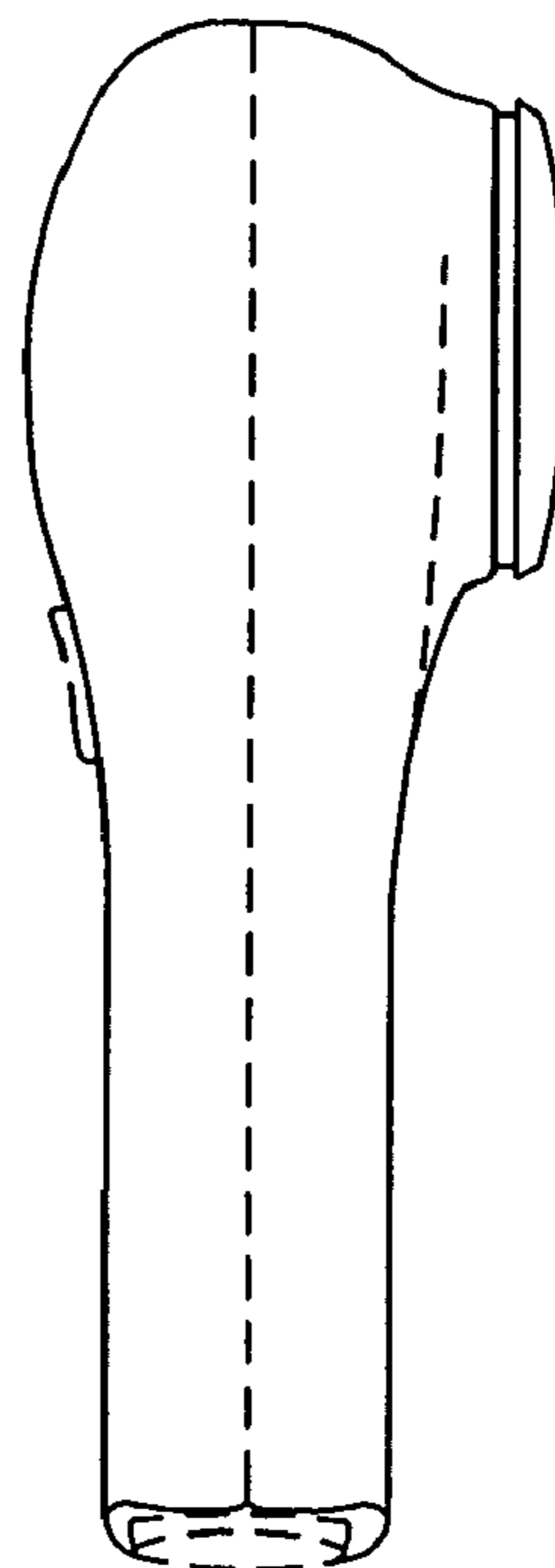

FIG. 13

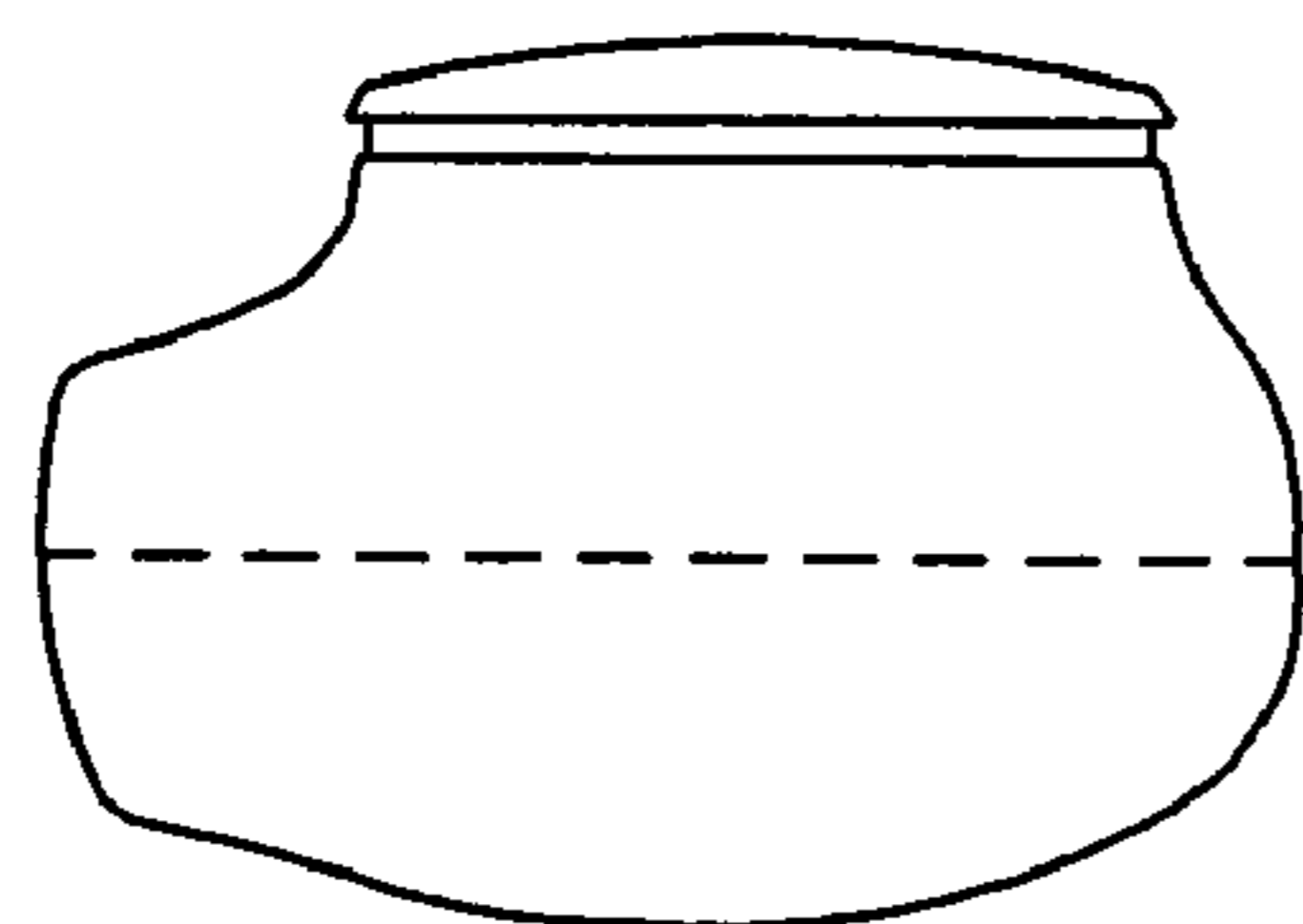

FIG. 14

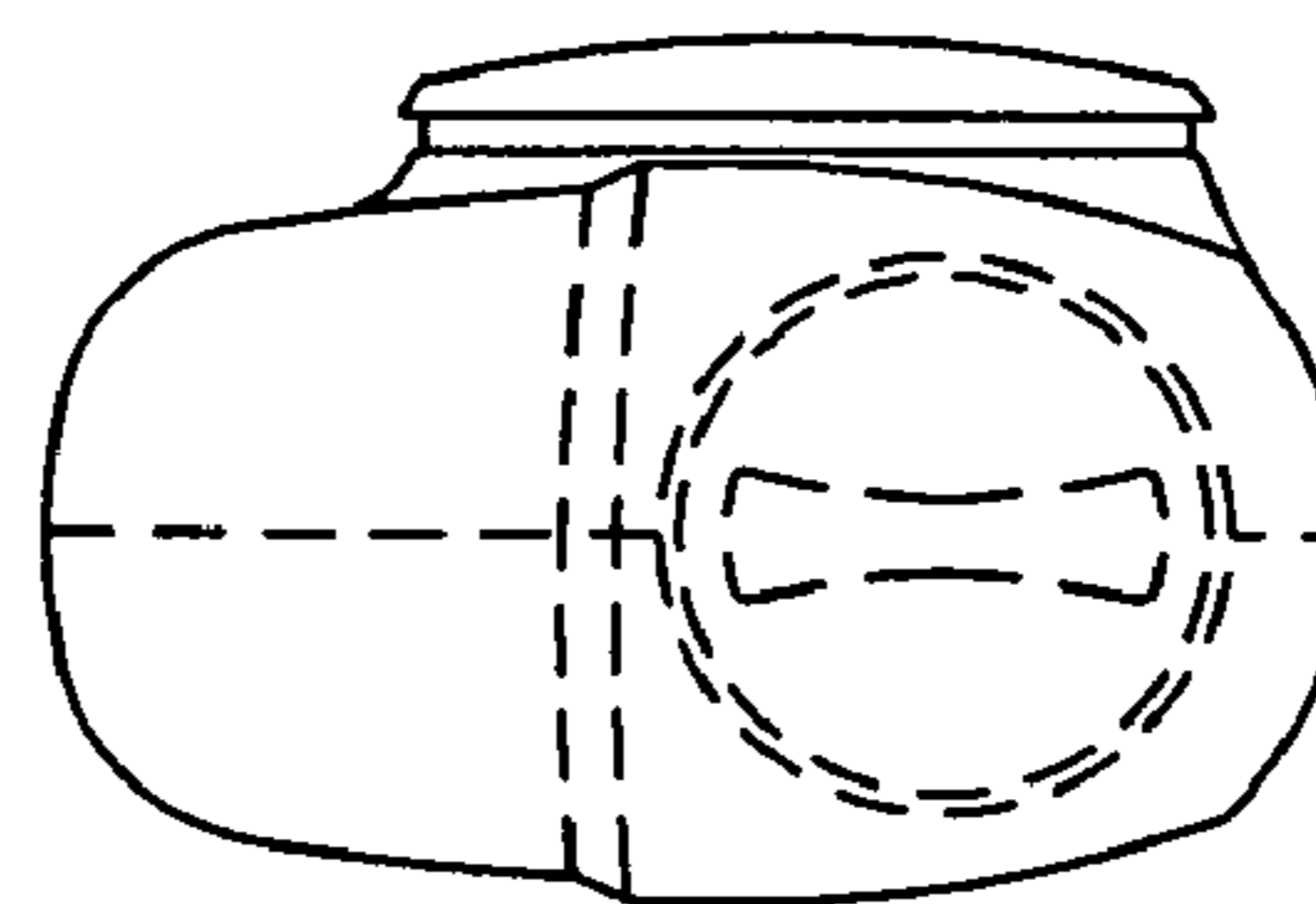

FIG. 15