



US00D623294S

(12) **United States Design Patent**
Rhoades et al.

(10) **Patent No.:** **US D623,294 S**
(45) **Date of Patent:** **** Sep. 7, 2010**

(54) **HANDHELD SKIN CARE TOOL**

(75) Inventors: **Dean Rhoades**, Beverly Hills, CA (US);
Robert Radi, Los Angeles, CA (US);
Kimber Maderazzo, Pacific Palisades,
CA (US)

(73) Assignee: **Guthy-Renker LLC**, Santa Monica, CA
(US)

(**) Term: **14 Years**

(21) Appl. No.: **29/346,589**

(22) Filed: **Nov. 3, 2009**

Related U.S. Application Data

(63) Continuation-in-part of application No. 29/289,072,
filed on Jul. 5, 2007, now Pat. No. Des. 608,002.

(51) **LOC (9) Cl.** **24-02**

(52) **U.S. Cl.** **D24/146; D24/133; D24/147**

(58) **Field of Classification Search** D24/133,
D24/146-147, 200, 214, 215; D28/57-59,
D28/62; 132/75.6, 76.4; 606/85, 131-133
See application file for complete search history.

(56) **References Cited**

U.S. PATENT DOCUMENTS

D226,043 S * 1/1973 Wolff D24/214
D269,377 S * 6/1983 Mackay et al. D24/214
D414,582 S * 9/1999 Hwang D24/214
6,312,397 B1 * 11/2001 Gebhard 601/15
6,652,888 B2 * 11/2003 Rhoades 606/131
D500,854 S * 1/2005 Eichel D24/146
D510,138 S * 9/2005 Kim D24/133

D533,943 S * 12/2006 Chen D24/146
D550,842 S * 9/2007 Koch et al. D24/146
D561,343 S * 2/2008 Liang D24/215
7,572,238 B2 * 8/2009 Rhoades 601/73
D608,002 S * 1/2010 Rhoades et al. D24/146

* cited by examiner

Primary Examiner—Ian Simmons

Assistant Examiner—Wan Laymon

(74) *Attorney, Agent, or Firm*—Cislo & Thomas, LLP

(57) **CLAIM**

The ornamental design for a handheld skin care tool, as shown
and described.

DESCRIPTION

FIG. 1 is a perspective view of the handheld skin care tool;

FIG. 2 is a top view of the handheld skin care tool shown in
FIG. 1;

FIG. 3 is a bottom view of the handheld skin care tool shown
in FIG. 1;

FIG. 4 is a front view of the handheld skin care tool shown in
FIG. 1;

FIG. 5 is a right side view of the handheld skin care tool
shown in FIG. 1;

FIG. 6 is left side view of the handheld skin care tool shown
in FIG. 1; and,

FIG. 7 is a rear view of the handheld skin care tool shown in
FIG. 1.

The broken line portions of the disclosure are included for the
purpose of illustrating environment and form no part of the
claimed design.

1 Claim, 4 Drawing Sheets

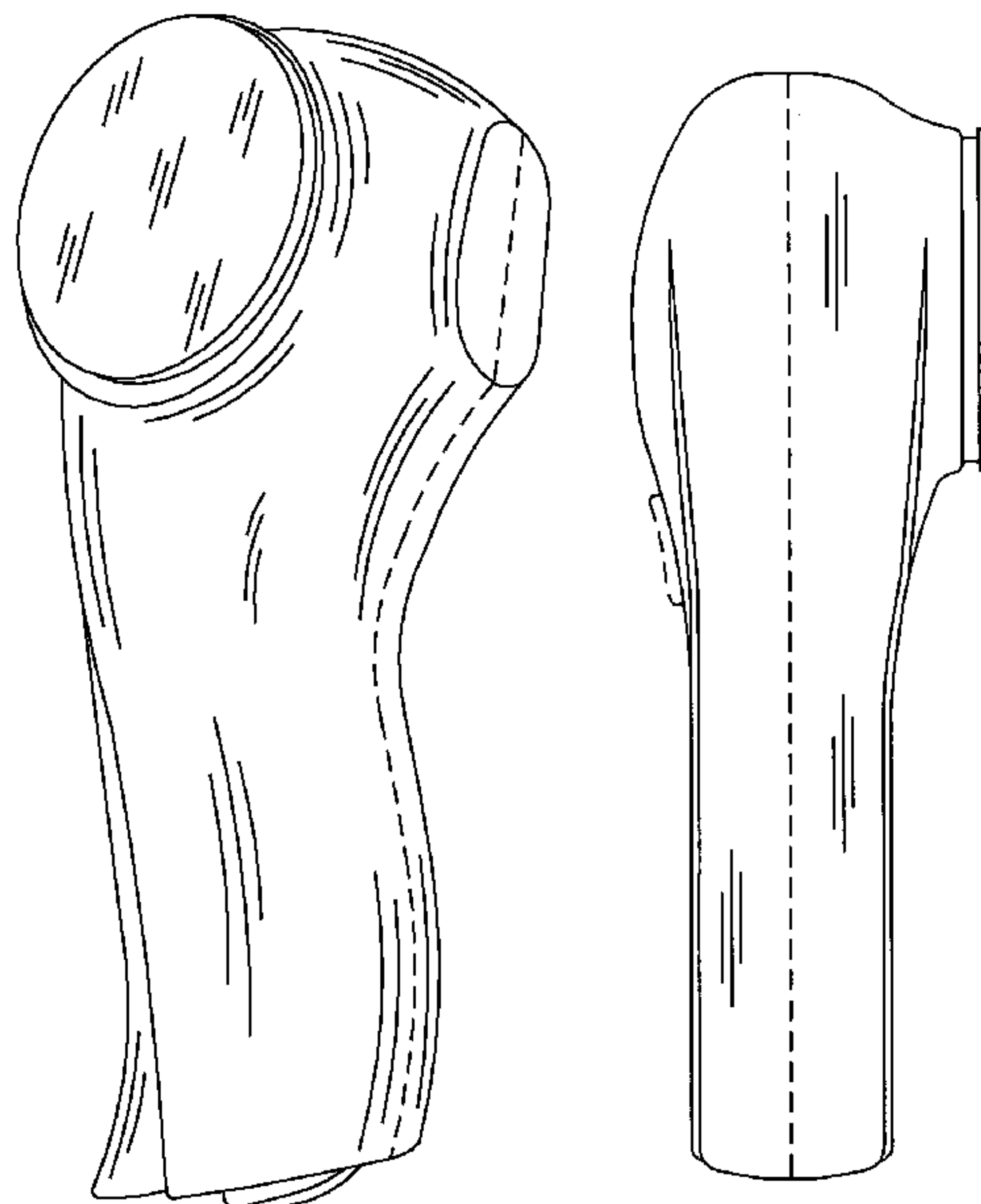

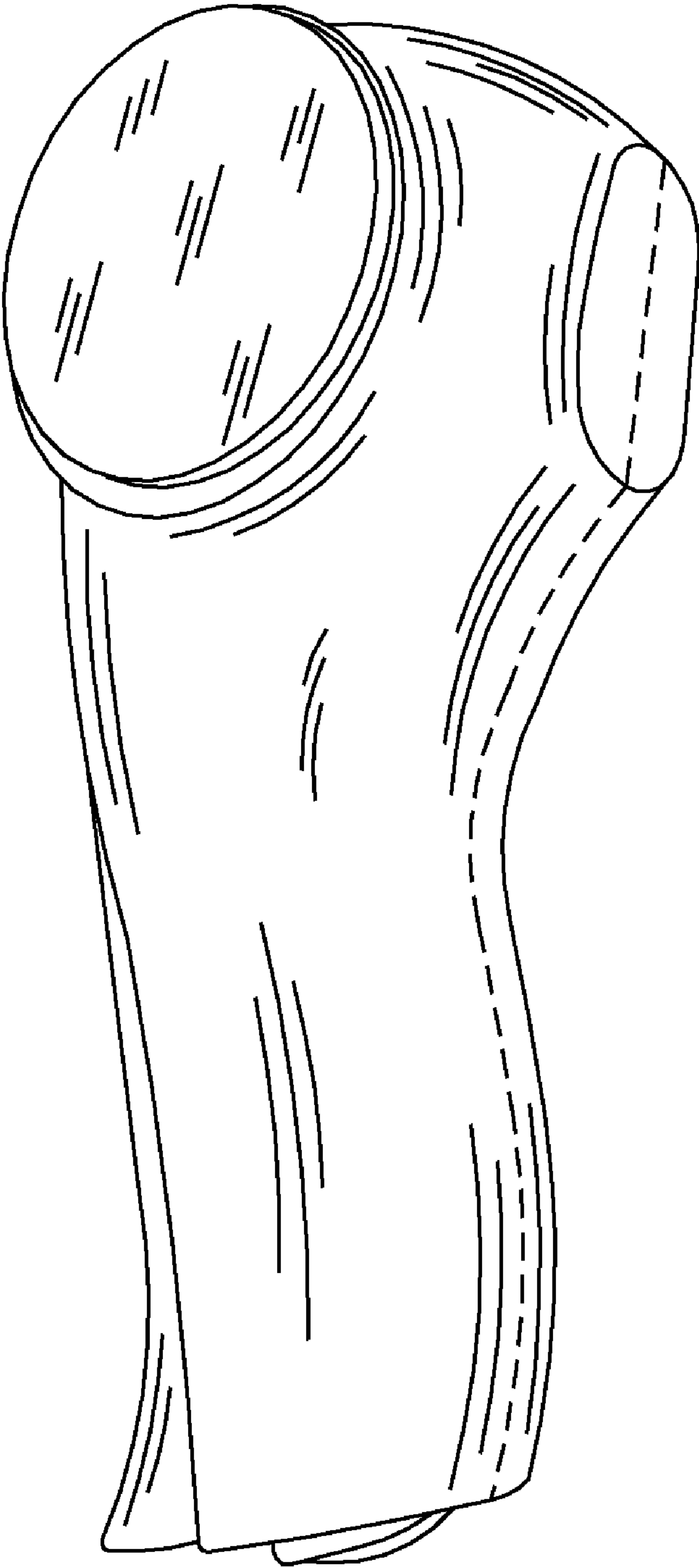

FIG. 1

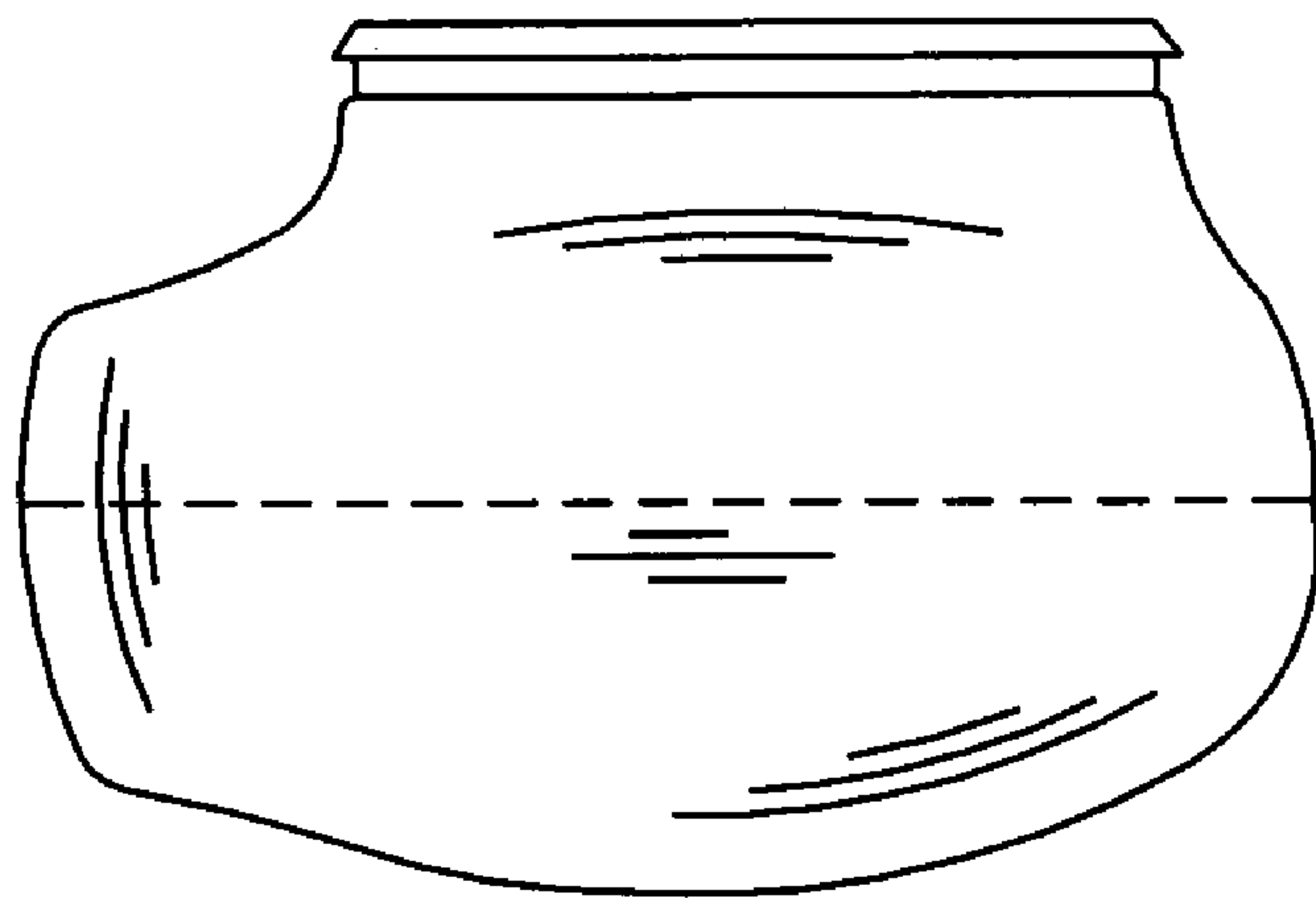

FIG. 2

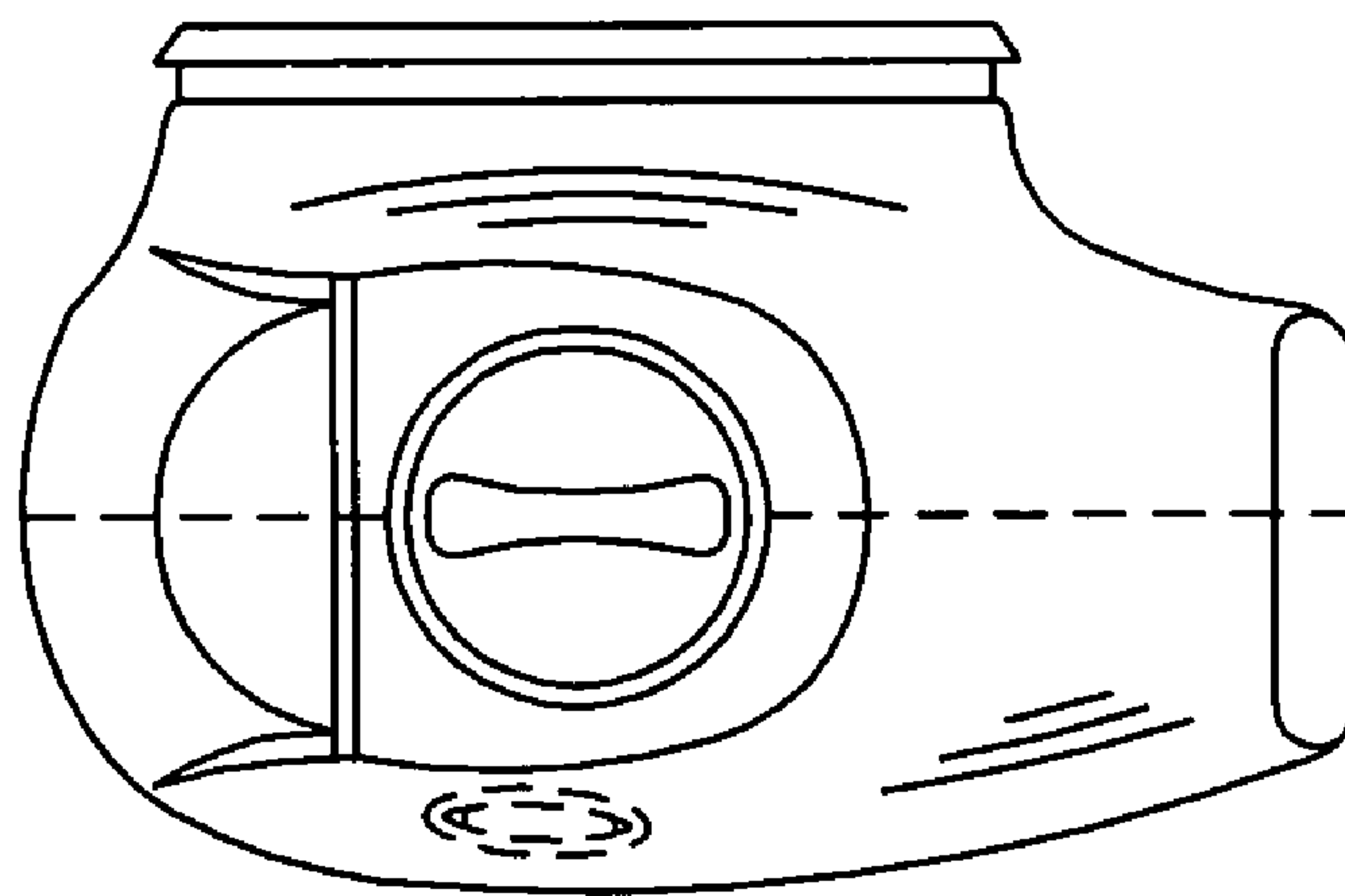

FIG. 3

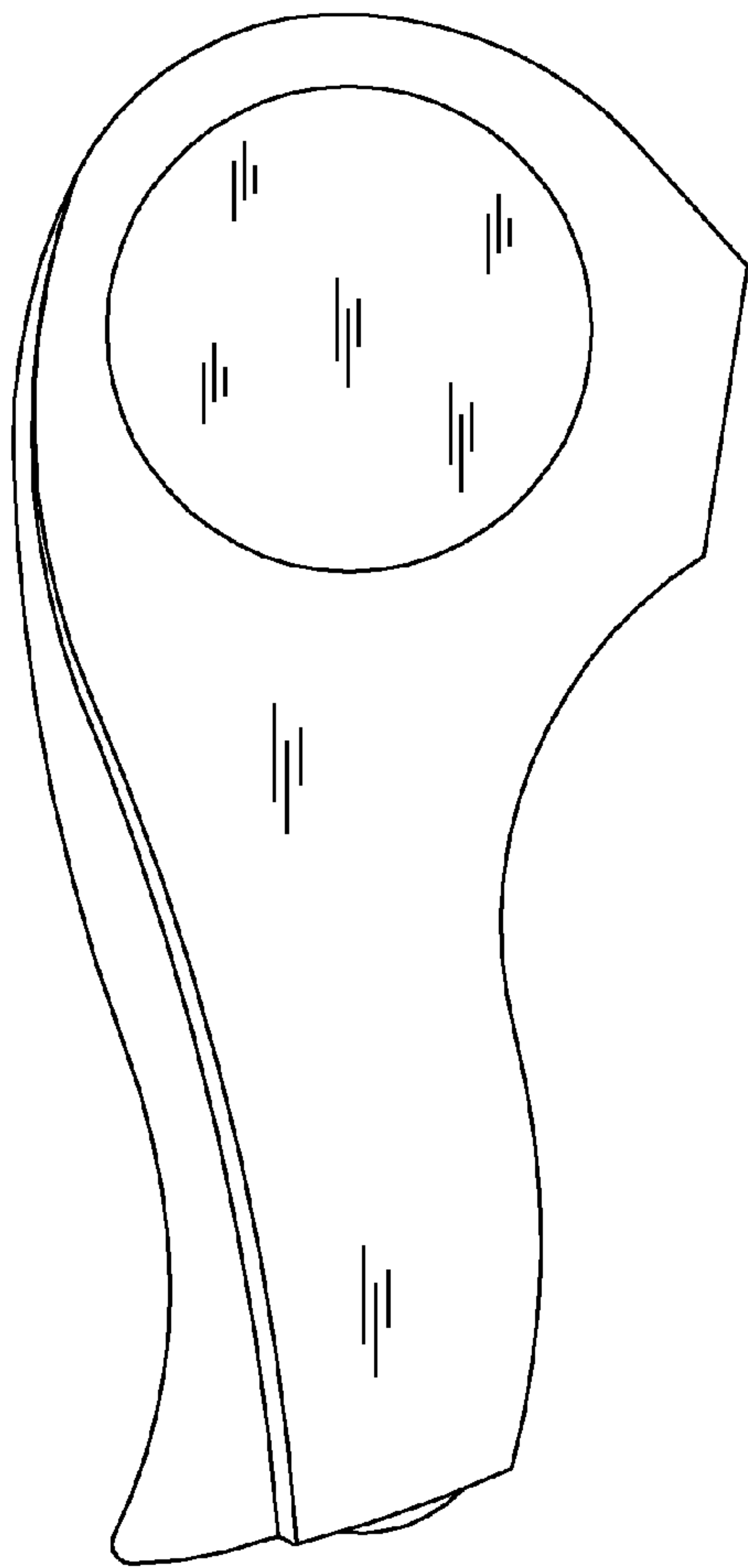

FIG. 4

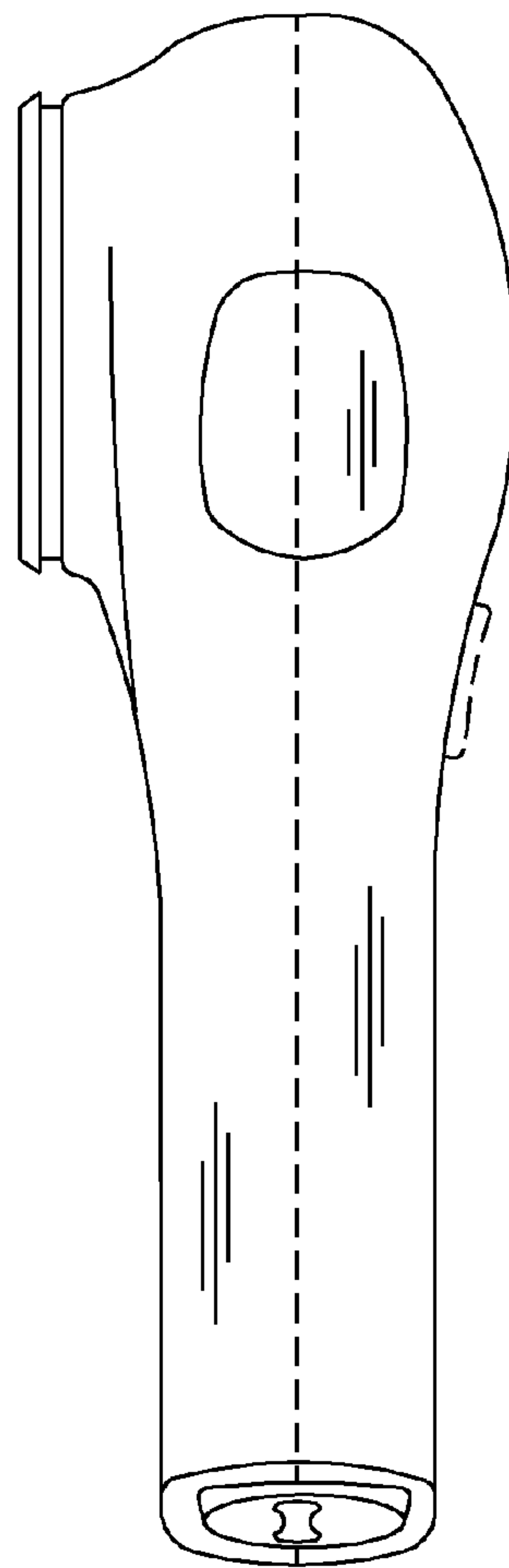

FIG. 5

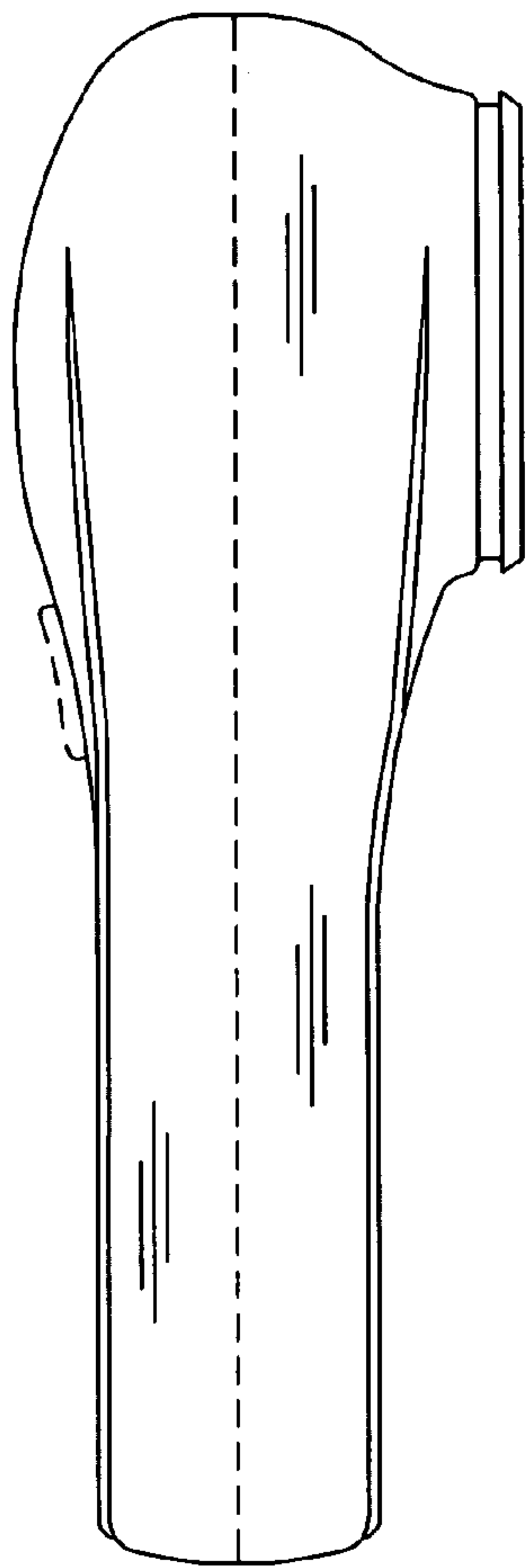

FIG. 6

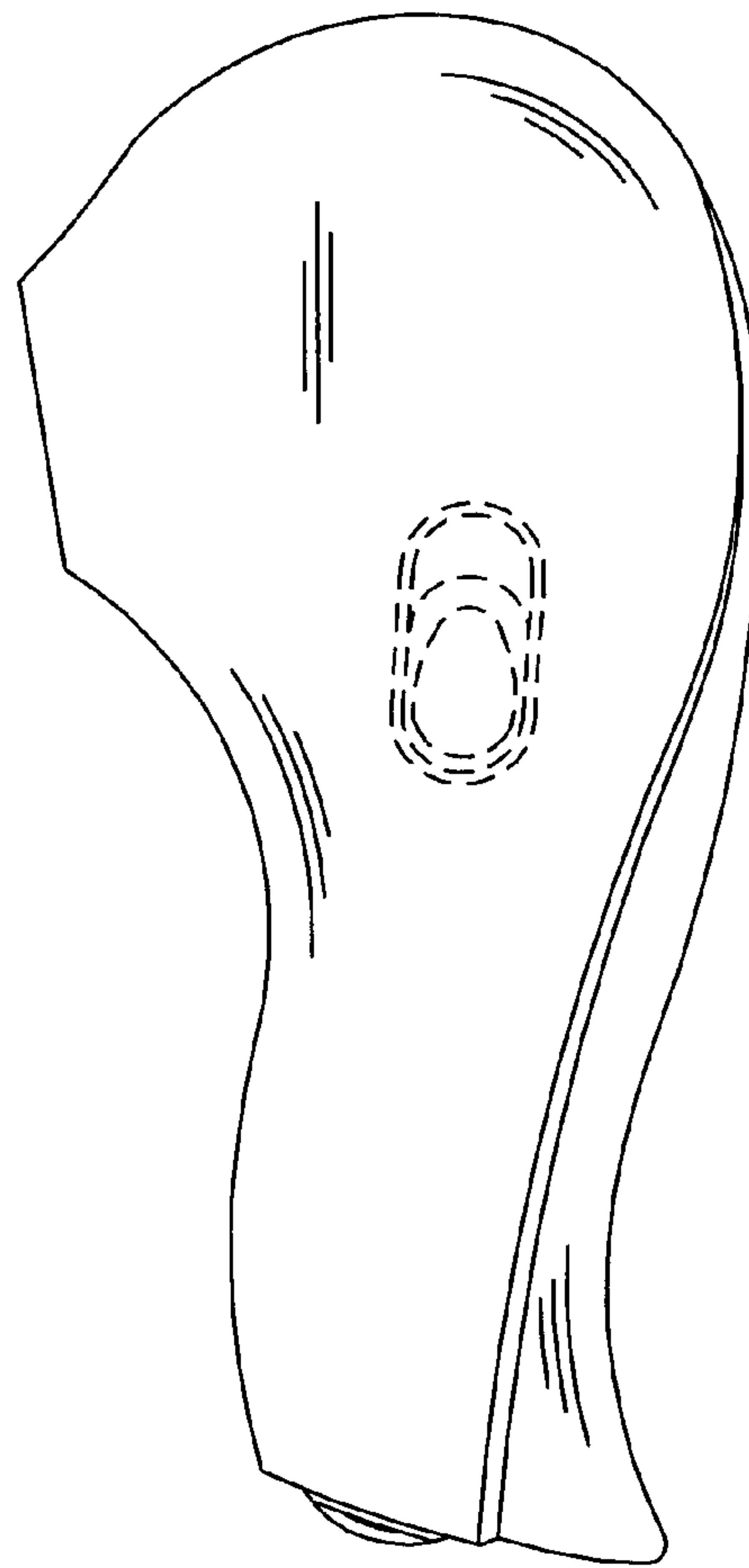

FIG. 7