



US00D623242S

(12) **United States Design Patent**
Greer

(10) **Patent No.:** **US D623,242 S**

(45) **Date of Patent:** **** Sep. 7, 2010**

(54) **FOLDING STRUCTURE**

(76) Inventor: **Scott Greer**, 1918 Lucille La., Pleasant Hill, CA (US) 94523

(**) Term: **14 Years**

(21) Appl. No.: **29/341,501**

(22) Filed: **Aug. 6, 2009**

(51) **LOC (9) Cl.** **21-01**

(52) **U.S. Cl.** **D21/511; D9/636**

(58) **Field of Classification Search** D21/483,
D21/506, 511, 548; D6/450; D3/271.6;
D7/354; D9/432, 433, 636, 637; D30/108,
D30/119, 120, 161; 52/64, 66, 70; 119/168,
119/498, 499; 229/108, 108.1, 120.1; 446/108,
446/109, 110, 112, 476, 478

See application file for complete search history.

(56) **References Cited**

U.S. PATENT DOCUMENTS

D134,429	S	*	11/1942	Seals	D9/636
D173,819	S	*	1/1955	Steelman	D9/636
3,231,942	A	*	2/1966	O'Brien	52/70
3,977,119	A	*	8/1976	Nelson	446/478
D244,172	S	*	5/1977	Lee	D30/108
D246,349	S	*	11/1977	Klupt	D9/636
4,190,978	A	*	3/1980	Nelson	446/478
D263,116	S	*	2/1982	Cain	D9/432
4,391,223	A	*	7/1983	Holland et al.	229/108
D274,916	S	*	7/1984	Hunt	D3/271.6
4,467,572	A	*	8/1984	Somers et al.	52/66
4,792,082	A	*	12/1988	Williamson	52/66
4,964,249	A	*	10/1990	Payne	52/70
4,978,301	A	*	12/1990	Dodge	446/108
D326,689	S	*	6/1992	Farinelli, Jr.	D21/511
5,120,262	A	*	6/1992	Caine	446/476
5,167,205	A	*	12/1992	Bell et al.	229/120.1
5,313,747	A	*	5/1994	Sakihara	52/64
D350,692	S	*	9/1994	Seki	D9/636

(Continued)

Primary Examiner—Cynthia M Chin

(74) *Attorney, Agent, or Firm*—QuickPatents, Inc.; Kevin Prince

(57) **CLAIM**

I claim the ornamental design for a folding structure, as shown and described.

DESCRIPTION

FIG. 1 is a front perspective view of a folding structure, illustrated in an assembled configuration with a roof section in a raised position, showing my new design;

FIG. 2 is a rear perspective view thereof, the roof section illustrated in a lowered position;

FIG. 3 is a front elevational view thereof, the roof section illustrated in the lowered position;

FIG. 4 is a rear elevational view thereof, the roof section illustrated in the lowered position;

FIG. 5 is a left-side elevational view thereof, the roof section illustrated in the lowered position, the right-side elevational view being a mirror image thereof;

FIG. 6 is a top plan view thereof, the roof section illustrated in the lowered position;

FIG. 7 is a bottom plan view thereof, the roof section illustrated in the lowered position;

FIG. 8 is an exploded perspective view thereof showing the side wall sections in a partially extended configuration;

FIG. 9 is an exploded perspective view thereof showing the side wall sections in a fully extended configuration;

FIG. 10 is a partially exploded perspective view thereof, showing the roof section exploded away from the wall section;

FIG. 11 is an environmental perspective view thereof, illustrated in a fully collapsed configuration; and,

FIG. 12 is an enlarged perspective view thereof, illustrated in the fully collapsed configuration.

The broken-lined pad and bag in FIGS. 1, 3, 8, 9, 10 & 11 illustrates the environment in which the design resides and forms no part of the claim.

1 Claim, 7 Drawing Sheets

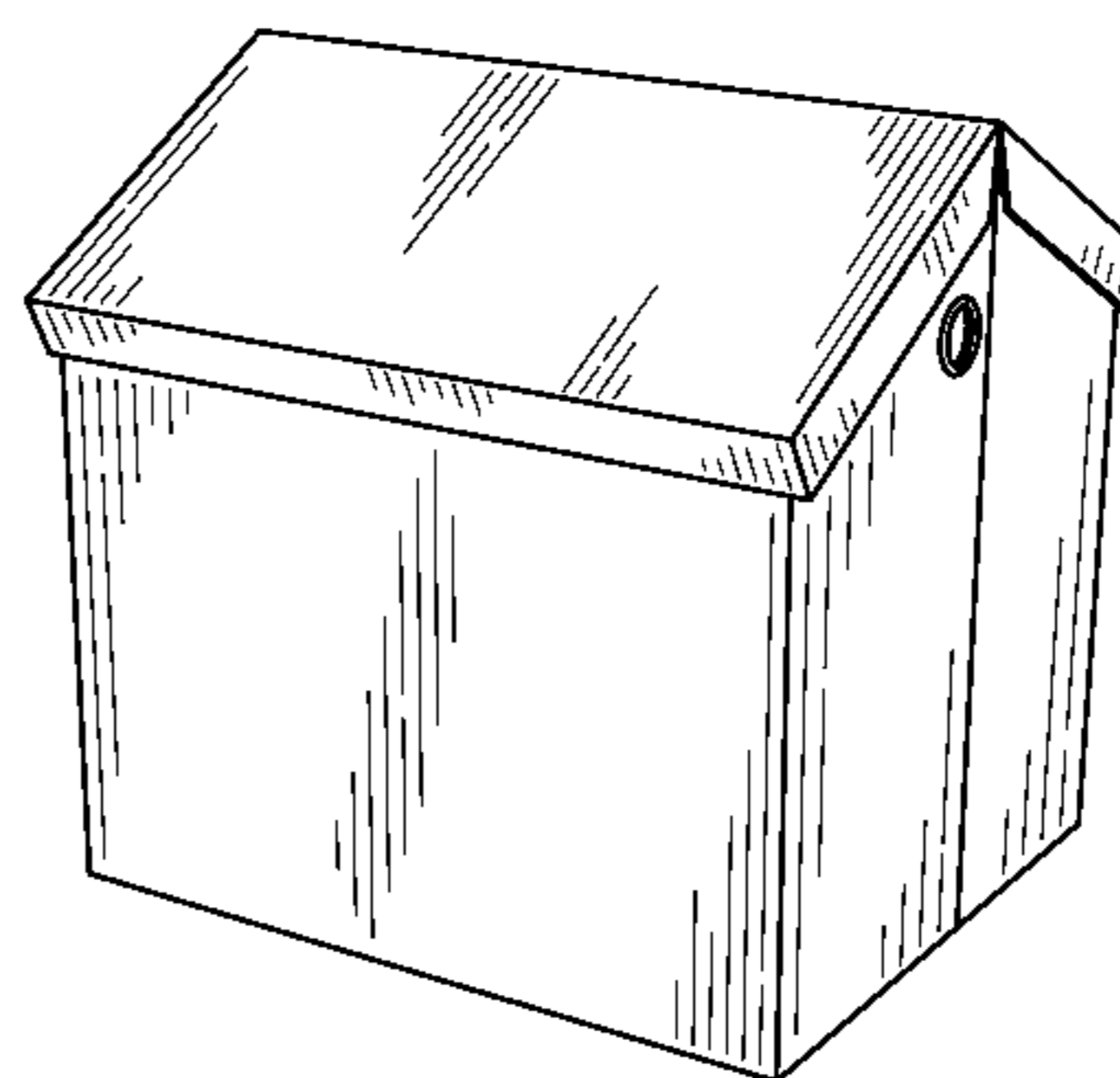
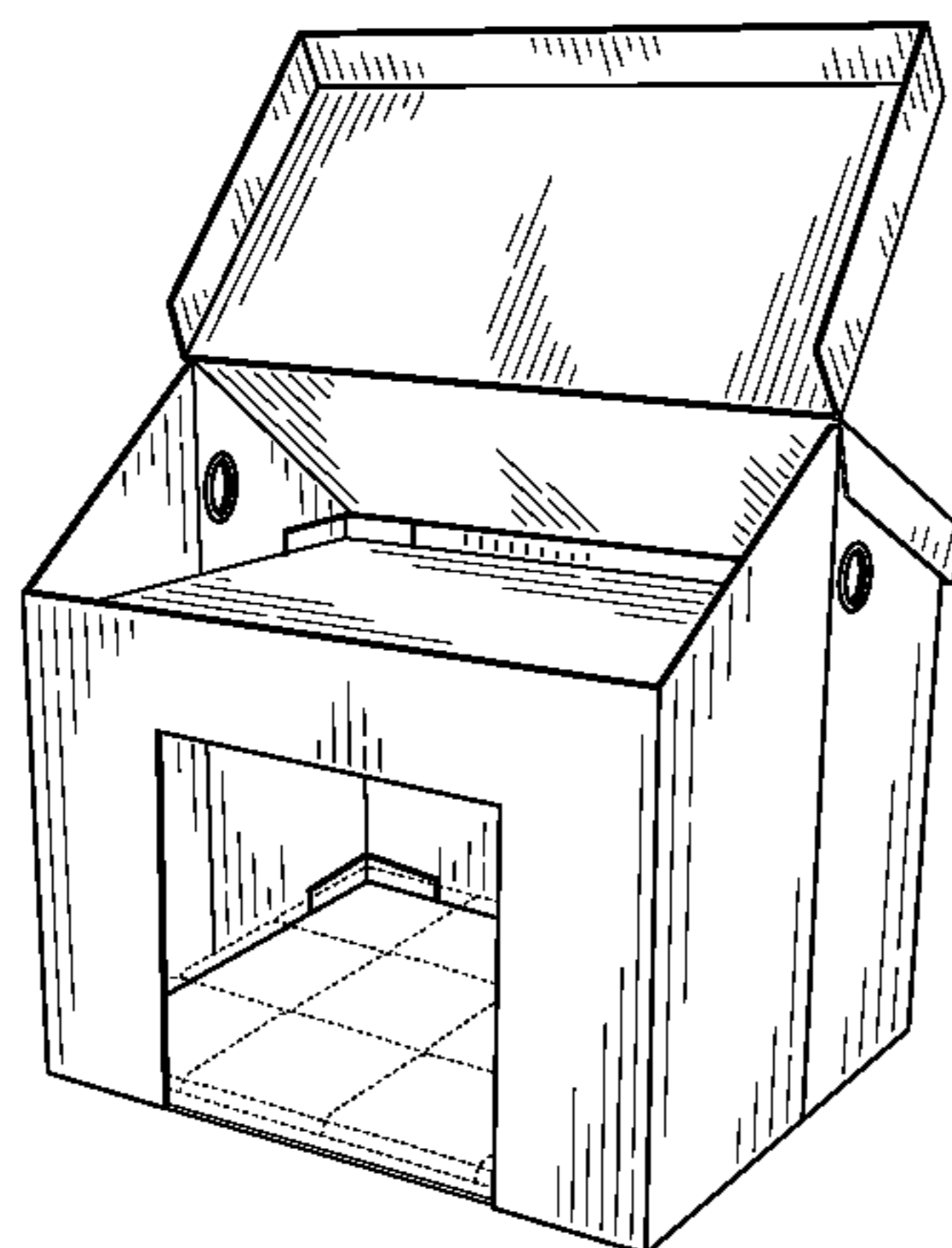

US D623,242 S

Page 2

U.S. PATENT DOCUMENTS

5,423,709	A *	6/1995	Summers	446/478	6,260,707	B1 *	7/2001	Harris	446/478
5,482,490	A *	1/1996	Weldon-Ming	446/478	6,607,421	B1 *	8/2003	Rossi	446/478
5,582,135	A *	12/1996	Bellows	119/168	D479,370	S *	9/2003	Neves	D30/161
D377,406	S *	1/1997	McKinstry	D30/108	6,758,167	B1 *	7/2004	Edelinski	446/476
D380,021	S *	6/1997	Hartsfield	D21/511	D502,616	S *	3/2005	Tamburri	D6/450
D383,177	S *	9/1997	Darneille	D21/511	7,104,221	B2 *	9/2006	Simon	446/478
5,752,470	A *	5/1998	Koneke	119/499	D566,391	S *	4/2008	McGee	D3/271.6
D430,236	S *	8/2000	Reithmeier	D21/548	D575,509	S *	8/2008	Evans	D3/271.6
6,108,982	A *	8/2000	Davison	52/64	7,552,563	B2 *	6/2009	Becker	229/108
D432,593	S *	10/2000	Naughton	D21/511	2004/0166765	A1 *	8/2004	Martin et al.	446/478

* cited by examiner

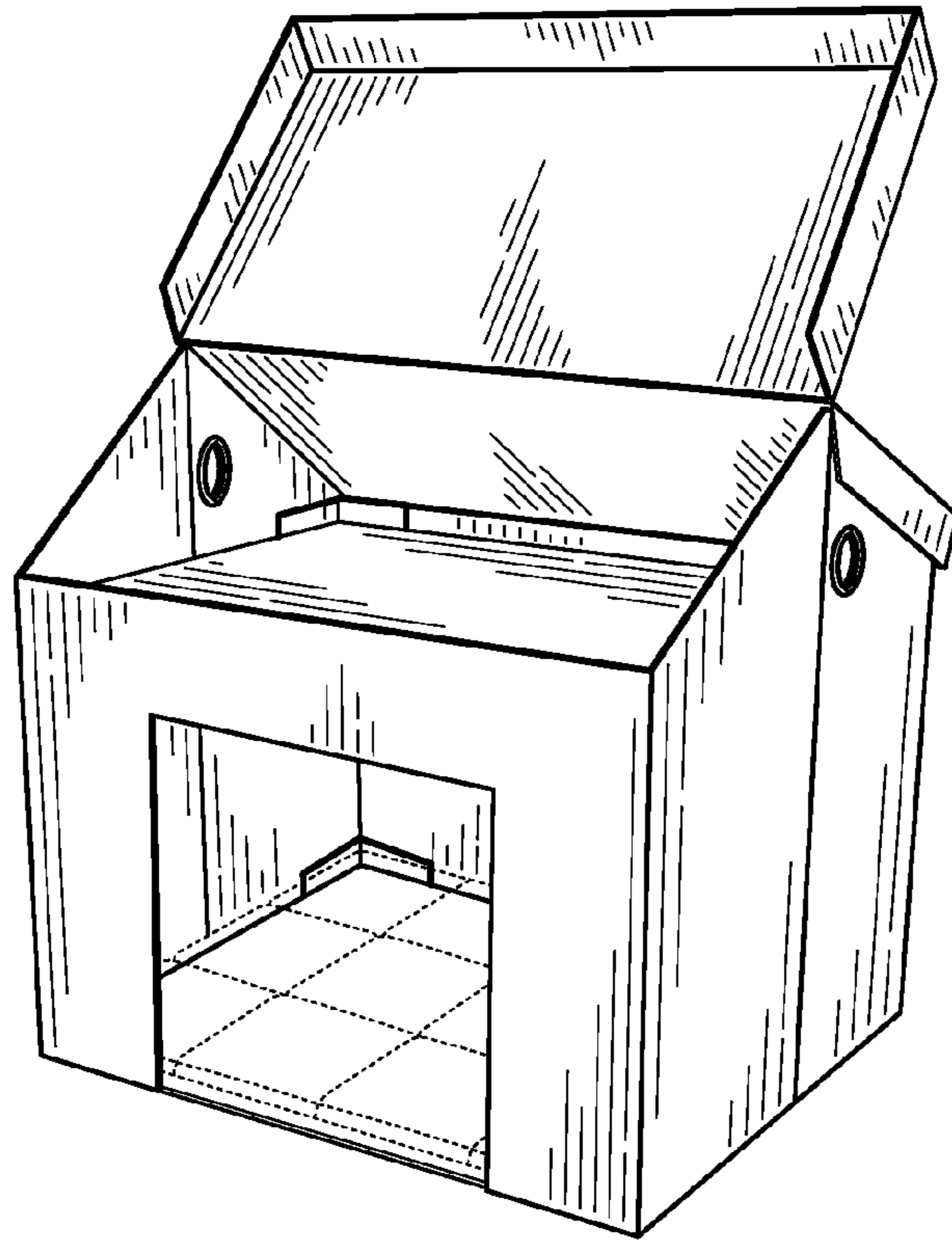

FIG. 1

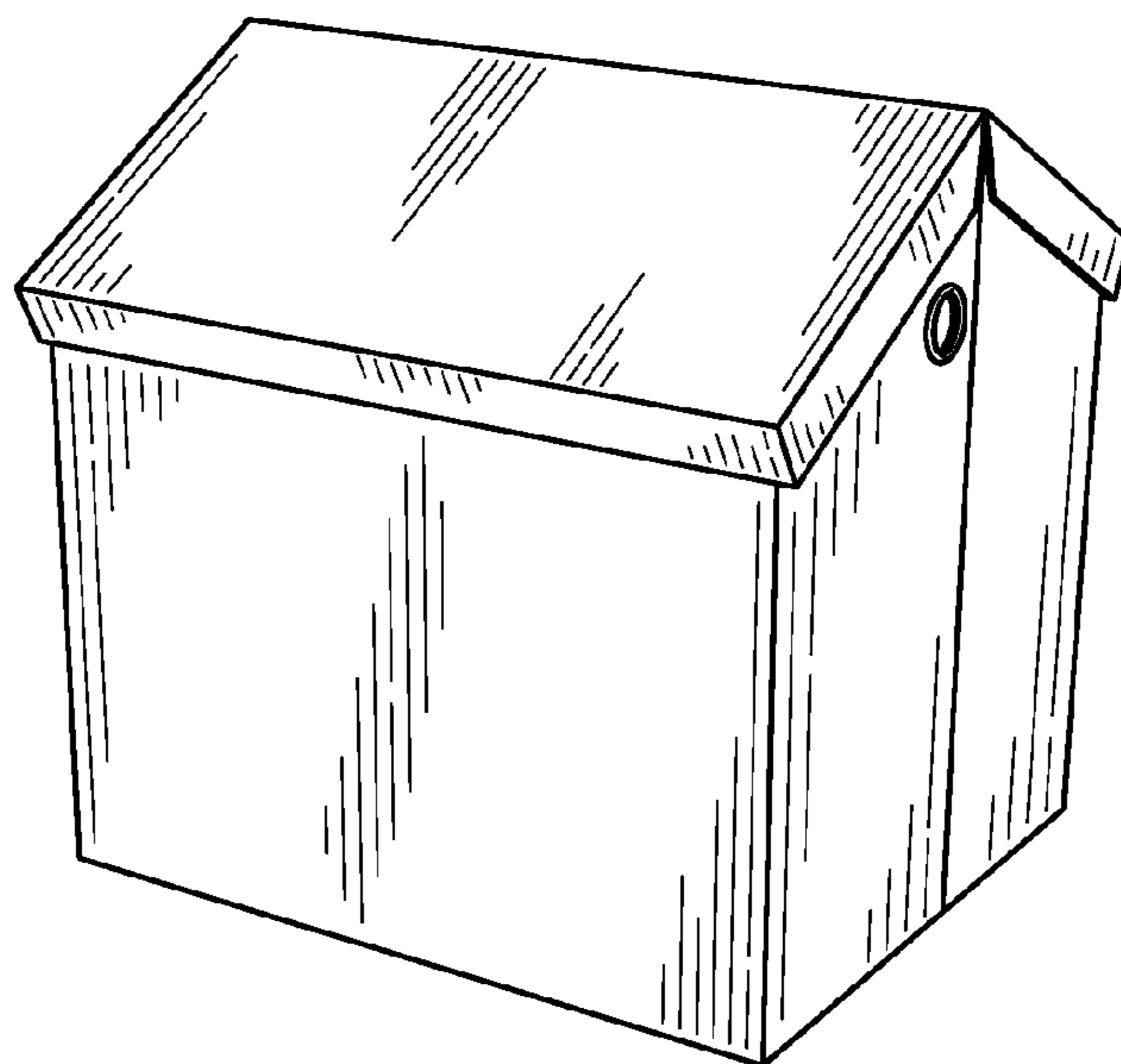

FIG. 2

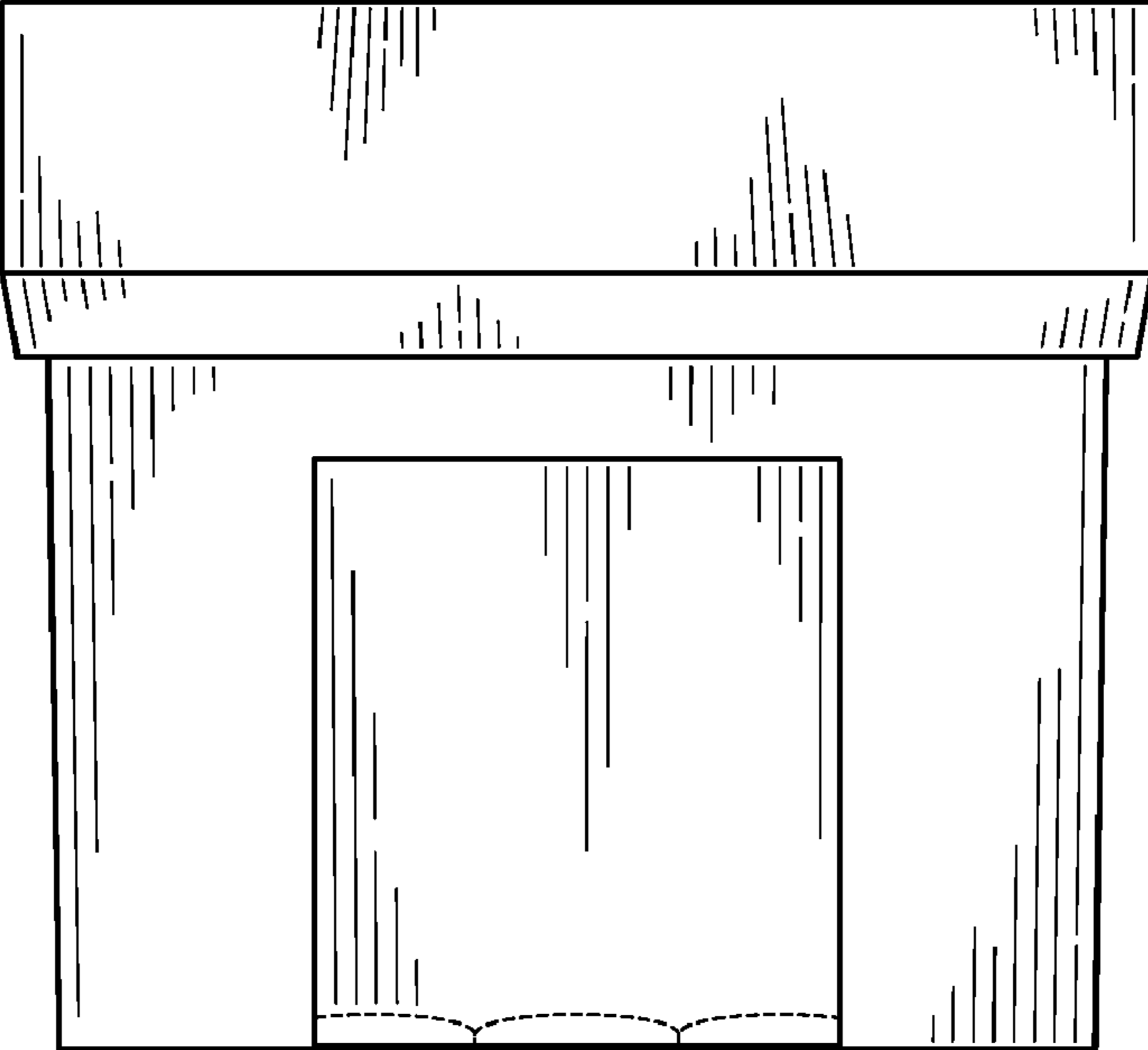

FIG. 3

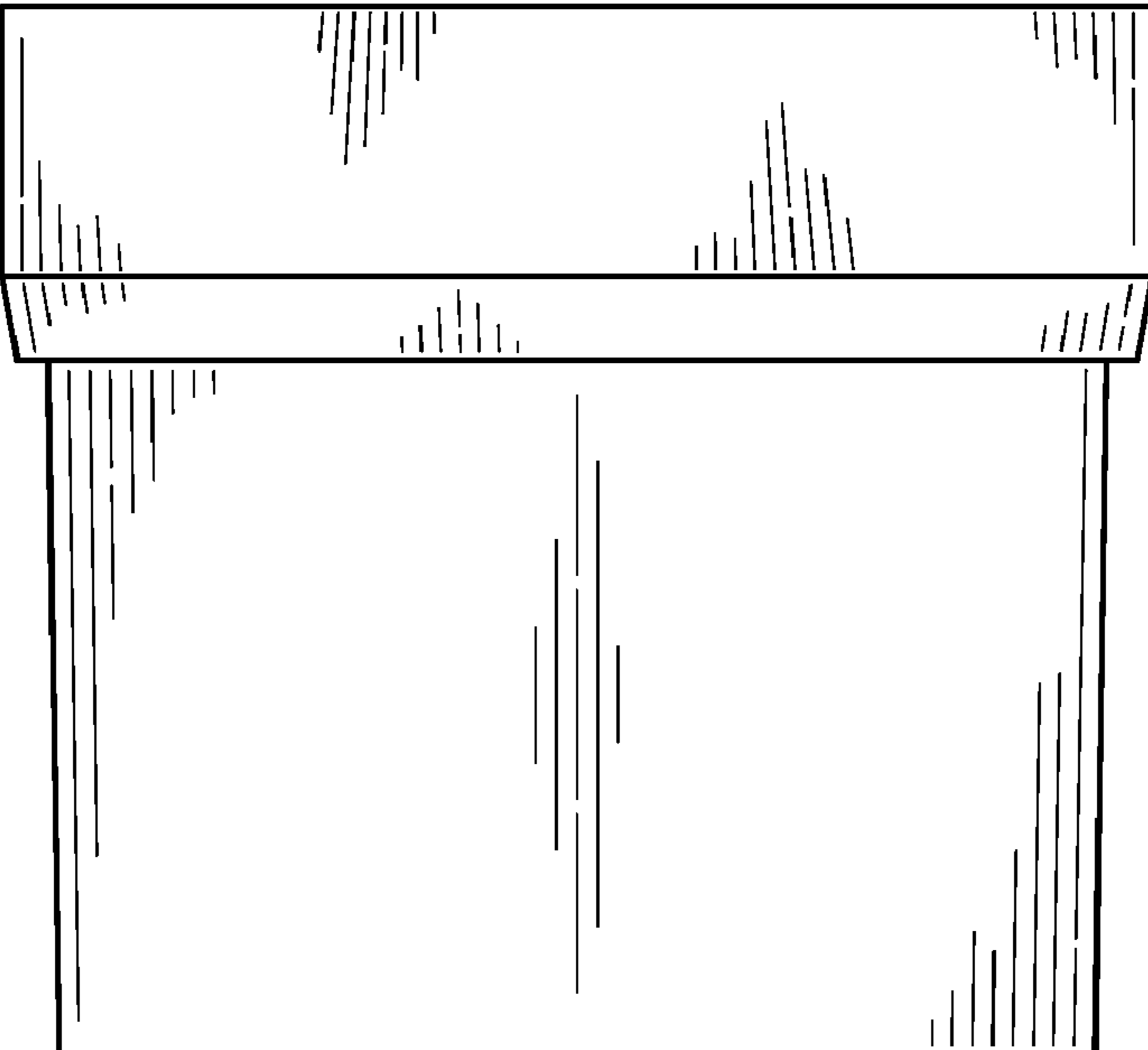

FIG. 4

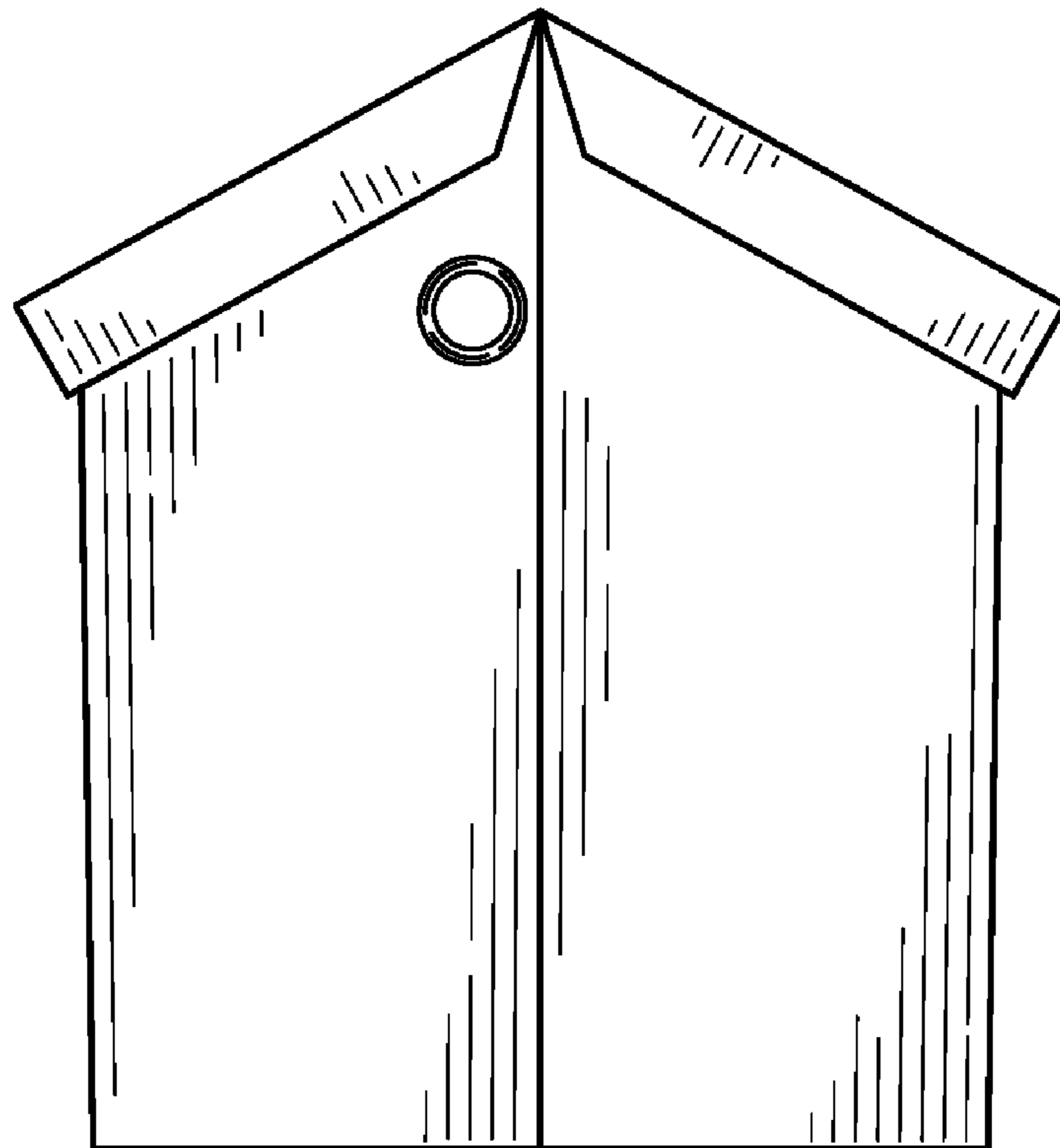

FIG. 5

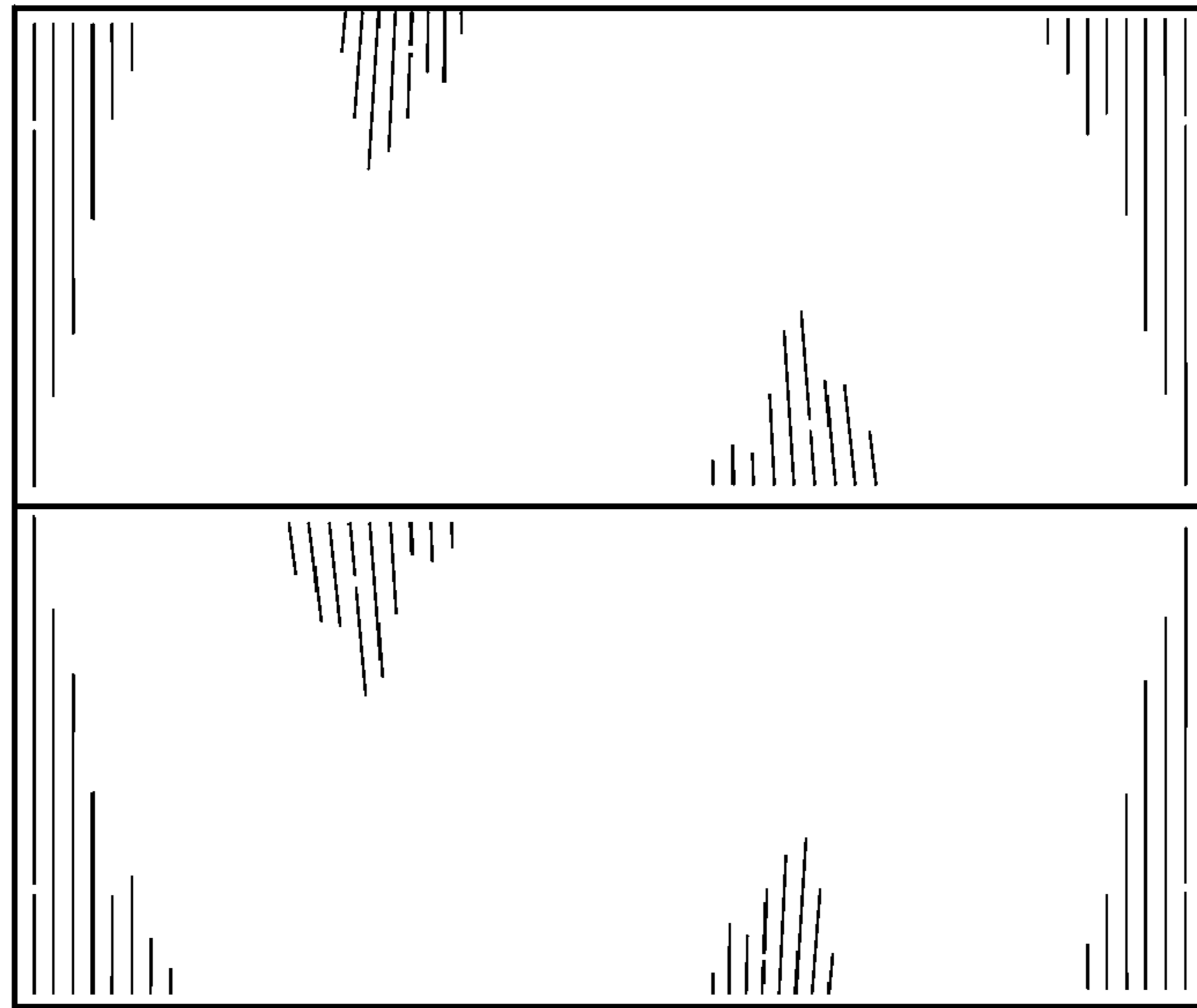

FIG. 6

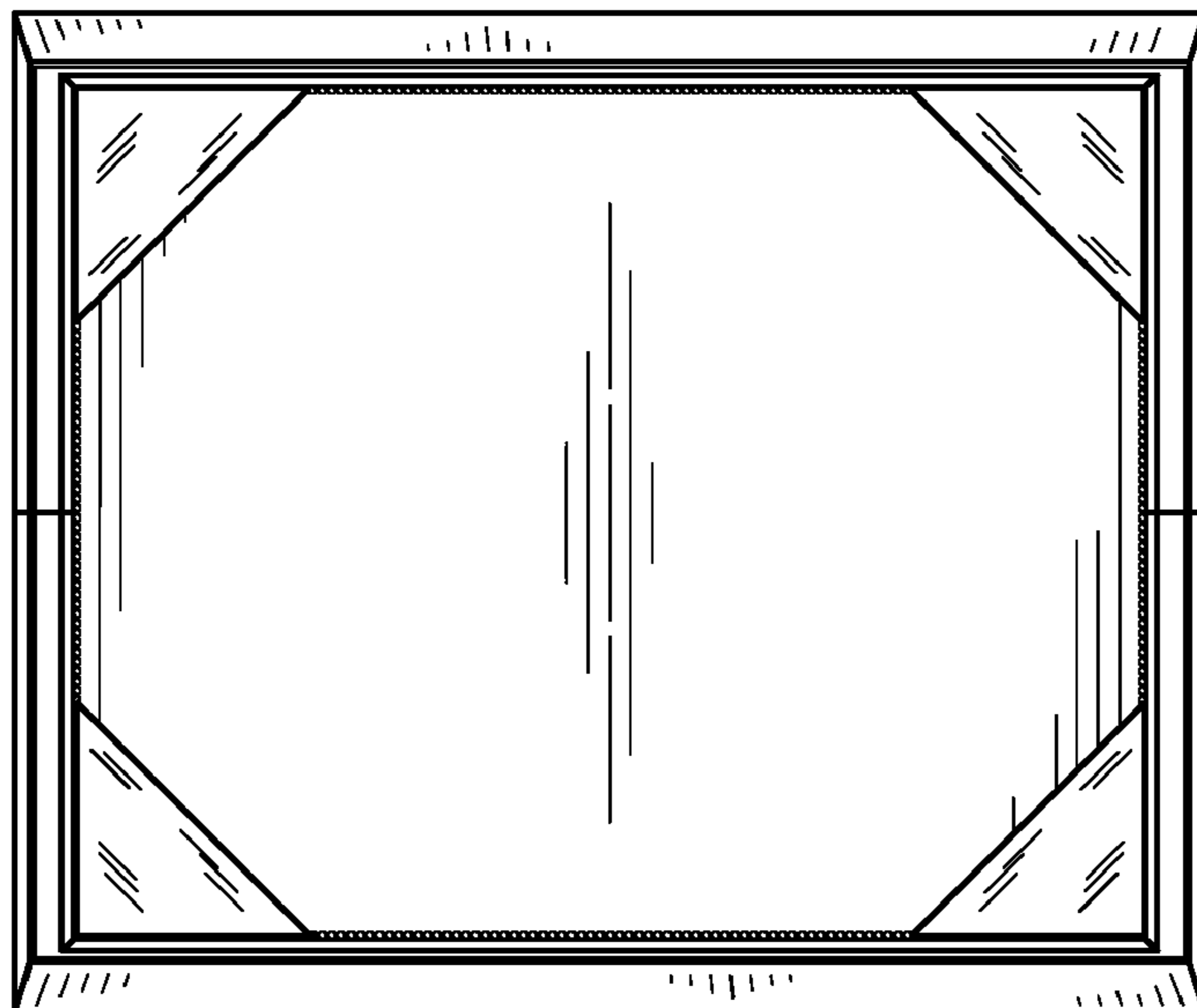

FIG. 7

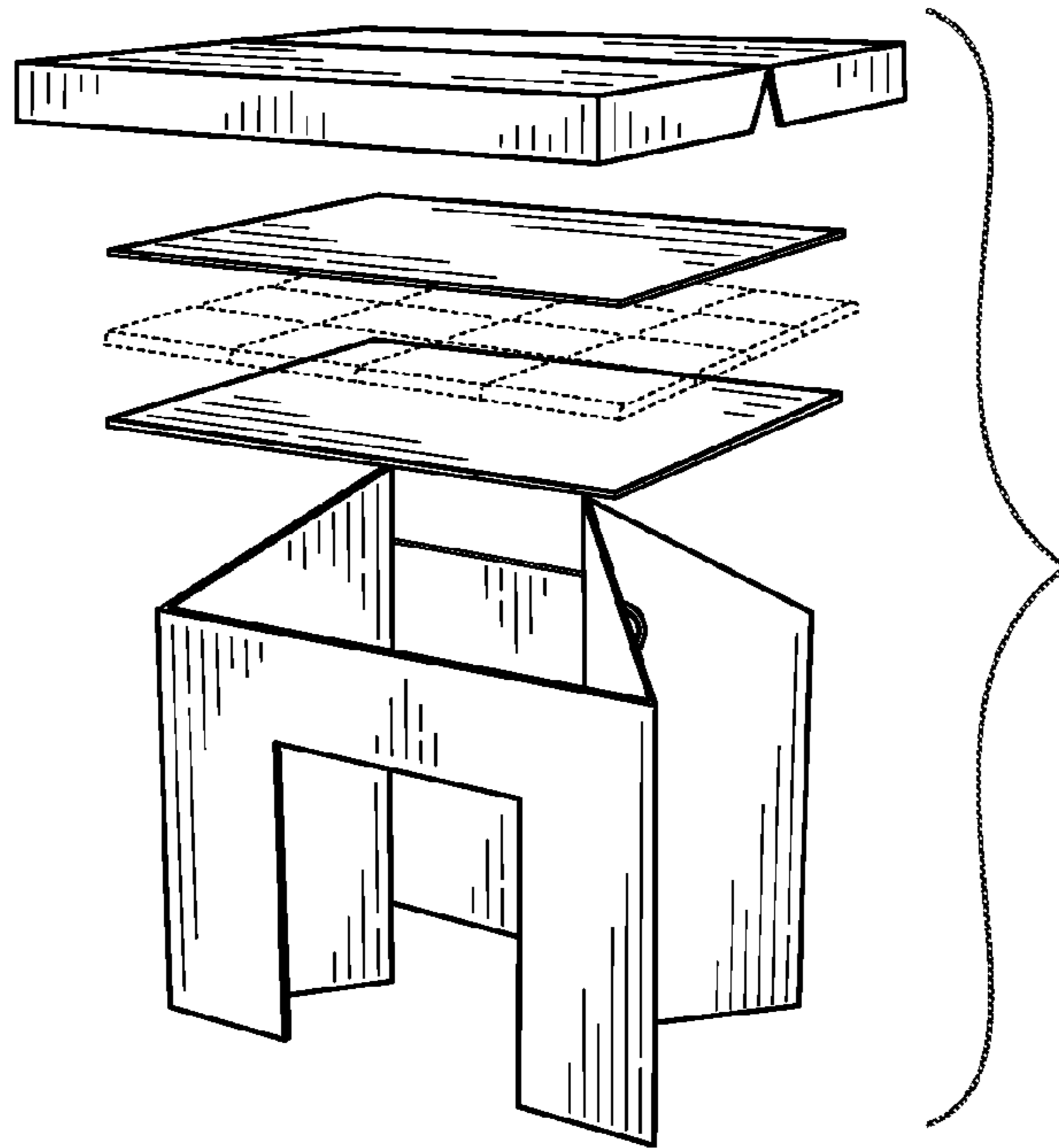

FIG. 8

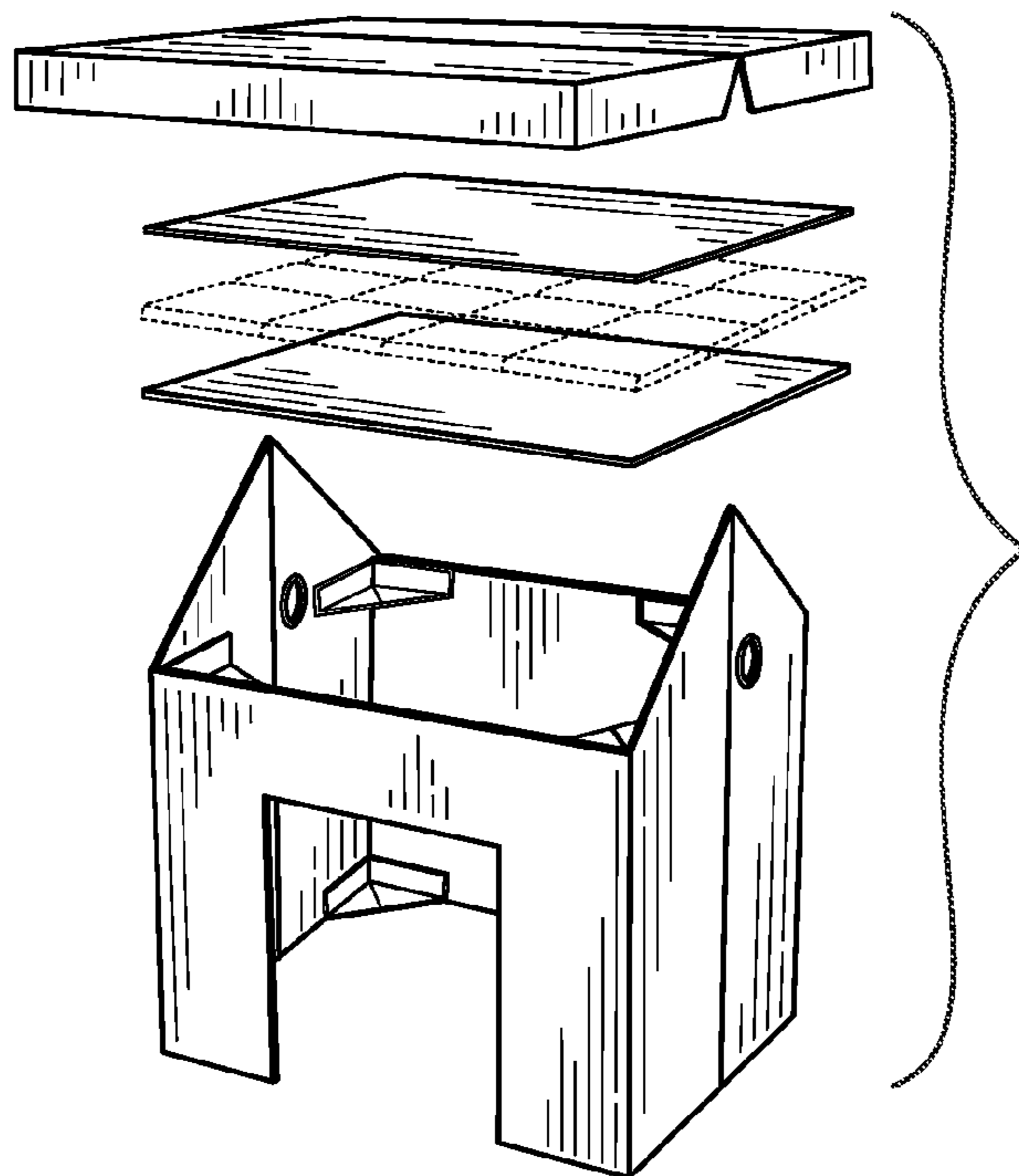

FIG. 9

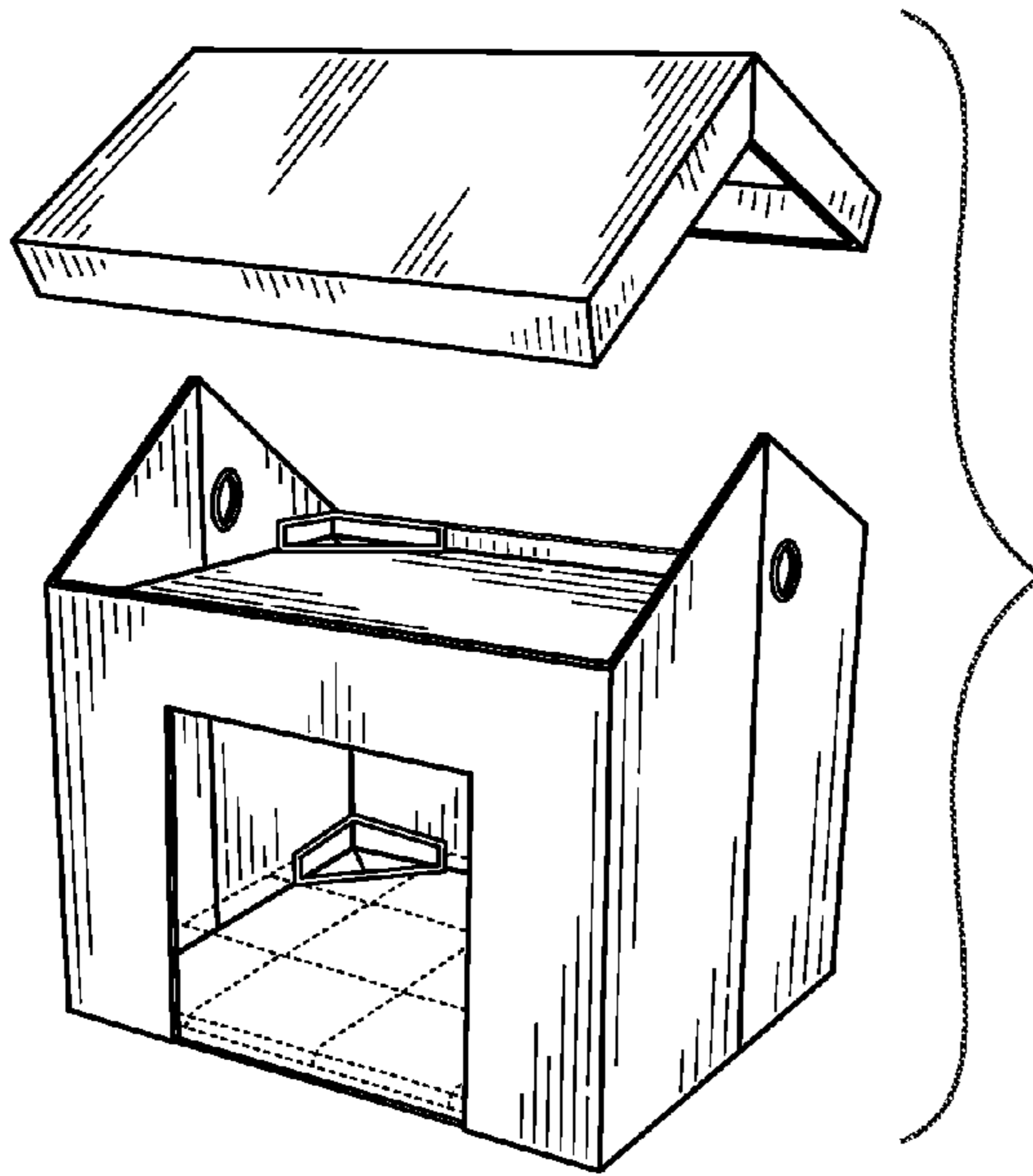

FIG. 10

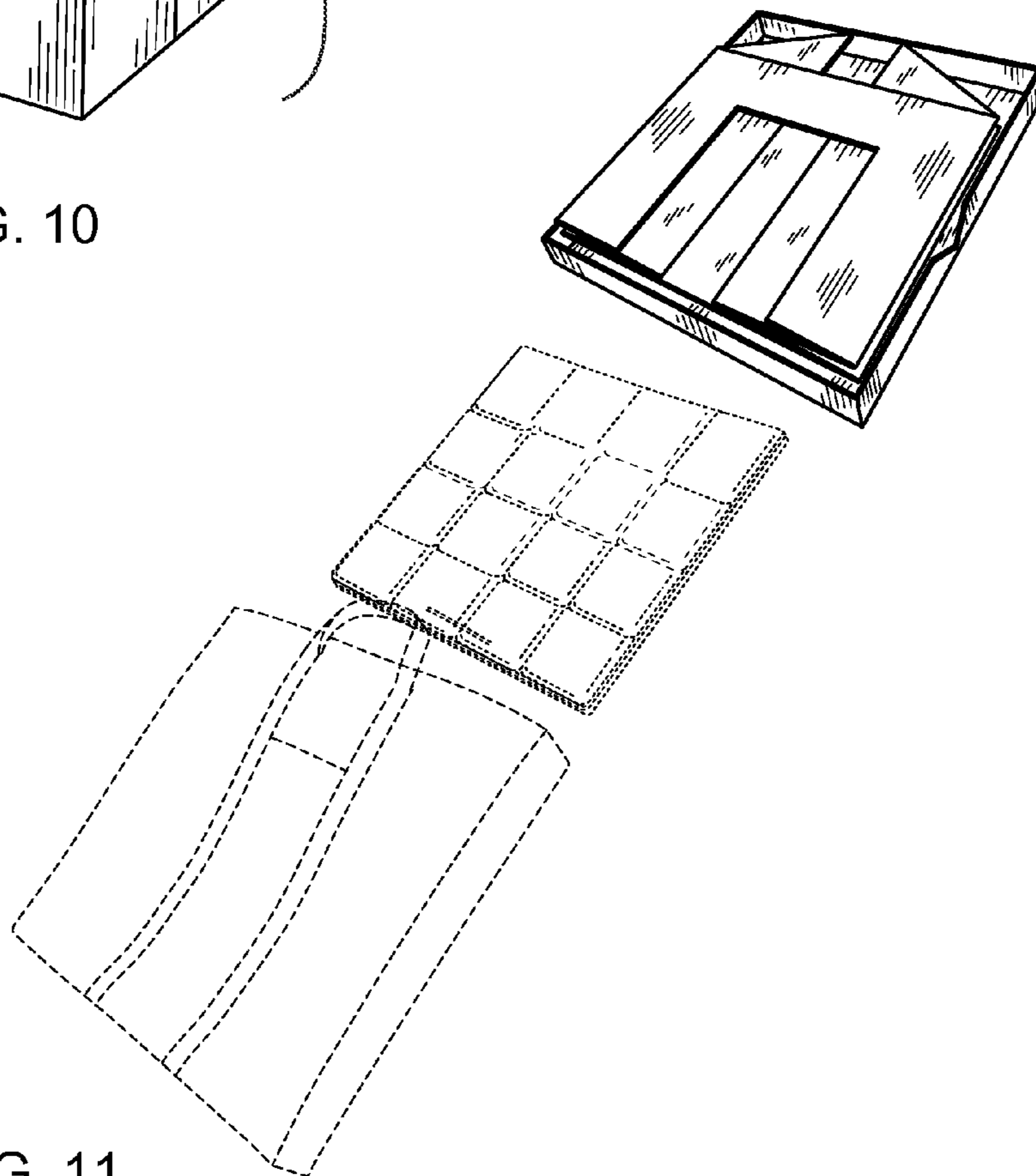

FIG. 11

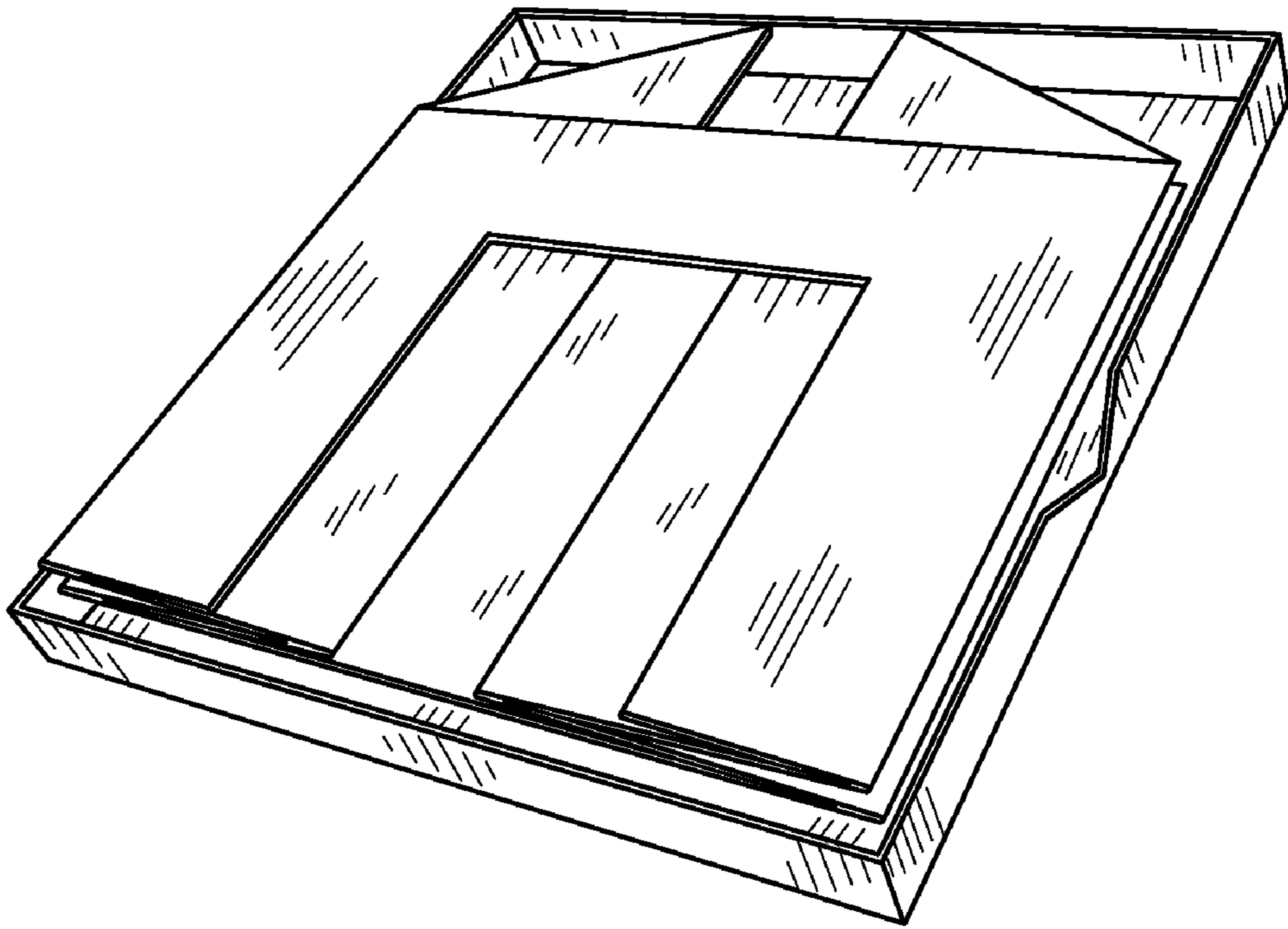

FIG. 12