



US00D623180S

(12) **United States Design Patent**
Diebel

(10) **Patent No.:** **US D623,180 S**

(45) **Date of Patent:** **** Sep. 7, 2010**

(54) **PORTABLE ELECTRONIC DEVICE CASE**

(74) *Attorney, Agent, or Firm*—Aka Chan LLP

(75) Inventor: **Markus Diebel**, San Francisco, CA (US)

(57) **CLAIM**

(73) Assignee: **Incase Designs Corp.**, Irwindale, CA (US)

The ornamental design for a portable electronic device case, as shown and described.

(**) Term: **14 Years**

(21) Appl. No.: **29/364,348**

(22) Filed: **Jun. 22, 2010**

DESCRIPTION

Related U.S. Application Data

(63) Continuation of application No. 29/363,974, filed on Jun. 16, 2010.

FIG. 1 shows a perspective front view of a first embodiment for a design for a portable electronic device case.

FIG. 2 shows a perspective back view of the first embodiment.

FIG. 3 shows a front view of the first embodiment.

FIG. 4 shows a back view of the first embodiment.

FIG. 5 shows a left side view of the first embodiment.

FIG. 6 shows a right side view of the first embodiment.

FIG. 7 shows a top side view of the first embodiment.

FIG. 8 shows a bottom side view of the first embodiment.

FIG. 9 shows a perspective front view of a second embodiment for a design for a portable electronic device case, where upper and lower case portions are separated.

FIG. 10 shows a perspective back view of the second embodiment, where upper and lower case portions are separated.

FIG. 11 shows a front view of the second embodiment, where upper and lower case portions are separated.

FIG. 12 shows a back view of the second embodiment, where upper and lower case portions are separated.

FIG. 13 shows a left side view of the second embodiment, where upper and lower case portions are separated; and,

FIG. 14 shows a right side view of the second embodiment, where upper and lower case portions are separated.

The broken lines immediately adjacent the shaded surfaces represent boundaries of the claimed design. All other broken lines are directed to environment. The broken lines and unshaded regions within the broken lines form no part of the claimed design.

- (51) **LOC (9) Cl.** **14-03**
- (52) **U.S. Cl.** **D14/250**
- (58) **Field of Classification Search** D14/203.1, D14/203.3, 250–253, 358, 440, 450; D3/201, D3/218, 269, 301, 273; D13/103, 107–108; 220/4.02; 224/191, 240, 241, 245, 682–683; 248/309.1; 361/679.3, 679.56; 379/420.04, 379/426, 433.11, 446–447, 454, 455; 455/575.1, 455/575.6, 575.7, 575.8, 575.9; 190/100; 206/305, 320

See application file for complete search history.

(56) **References Cited**

U.S. PATENT DOCUMENTS

4,515,272 A 5/1985 Newhouse

(Continued)

OTHER PUBLICATIONS

Slider Shield for iPhone G1, <URL:http://www.agent18.com/productdetail/slider-shield-for-iphone-g1/92.aspx>, retrieved from internet Jul. 13, 2010.*

(Continued)

Primary Examiner—Robert M Spear
Assistant Examiner—Carla Jobe Wright

1 Claim, 11 Drawing Sheets

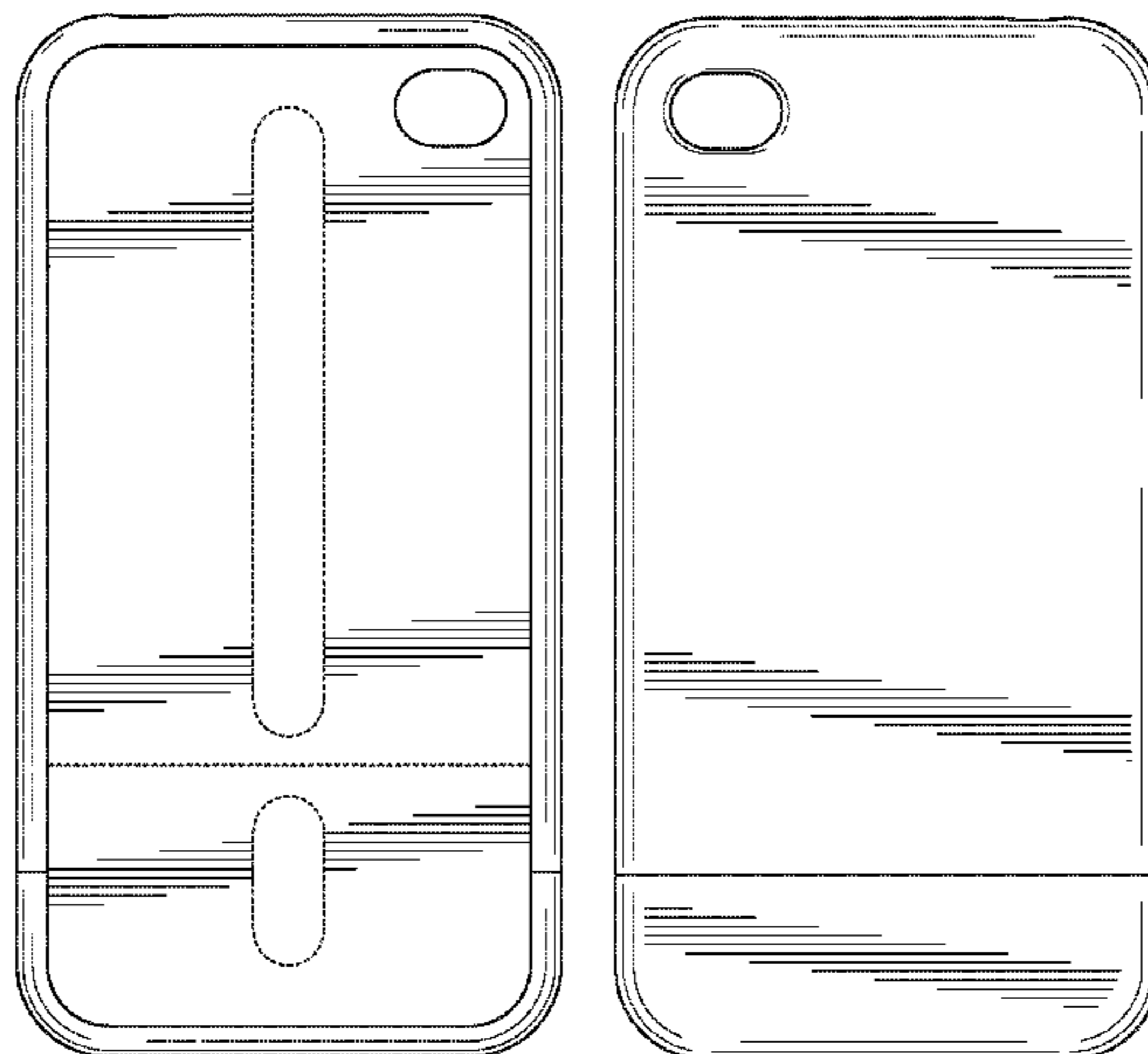

U.S. PATENT DOCUMENTS

D284,372 S 6/1986 Carpenter
 D312,534 S 12/1990 Nelson et al.
 D322,719 S 12/1991 Jayez
 5,360,108 A 11/1994 Alagia
 5,368,159 A 11/1994 Doria
 5,383,091 A 1/1995 Snell
 D357,918 S 5/1995 Doria
 D405,801 S 2/1999 Nagele et al.
 5,896,277 A 4/1999 Leon et al.
 6,201,867 B1 3/2001 Koike
 D469,427 S 1/2003 Ma et al.
 6,626,362 B1 9/2003 Steiner et al.
 D484,874 S 1/2004 Chang et al.
 D506,612 S 6/2005 Rosa et al.
 7,050,841 B1 5/2006 Onda
 D537,063 S 2/2007 Kim et al.
 7,194,291 B2 3/2007 Peng
 D540,539 S 4/2007 Gutierrez
 D543,541 S 5/2007 Chung et al.
 D547,056 S 7/2007 Griffin et al.
 D551,252 S 9/2007 Andre et al.
 D551,856 S 10/2007 Ko et al.
 D553,852 S * 10/2007 Brandenburg D3/218
 D556,681 S 12/2007 Kim
 D557,205 S 12/2007 Kim et al.
 D558,972 S 1/2008 Oh
 D561,092 S 2/2008 Kim
 D563,093 S 3/2008 Nussberger
 D565,290 S * 4/2008 Brandenburg et al. D3/218
 D565,291 S * 4/2008 Brandenburg et al. D3/218
 D574,819 S 8/2008 Andre et al.
 D575,056 S 8/2008 Tan
 D581,151 S 11/2008 Aipa
 D581,155 S * 11/2008 Richardson et al. D3/218
 D582,149 S 12/2008 Tan
 D582,405 S * 12/2008 Andre et al. D3/299
 D587,008 S * 2/2009 Richardson et al. D3/218
 D587,896 S 3/2009 Aipa
 D593,750 S * 6/2009 Song D3/269
 D597,089 S 7/2009 Khan et al.
 D603,389 S * 11/2009 Khan et al. D14/250
 D603,603 S 11/2009 Laine et al.
 7,612,997 B1 11/2009 Diebel et al.
 D606,305 S * 12/2009 Lee et al. D3/269
 D606,528 S * 12/2009 Khan et al. D14/250
 D606,529 S 12/2009 Ferrari et al.
 D606,751 S * 12/2009 Andre et al. D3/269
 D609,228 S 2/2010 Ferrari et al.
 D609,463 S 2/2010 Bullen
 D609,464 S * 2/2010 Bullen D3/218
 D610,807 S 3/2010 Bau
 D611,042 S 3/2010 Ferrari et al.
 D615,078 S * 5/2010 Bradley D14/250
 D615,536 S * 5/2010 Richardson et al. D14/250
 D616,360 S * 5/2010 Huang D13/103
 D616,361 S * 5/2010 Huang D13/103

D617,787 S 6/2010 Richardson et al.
 D618,230 S * 6/2010 Brown et al. D14/250
 D618,231 S * 6/2010 Fahrendorff et al. D14/250
 D619,130 S * 7/2010 Fellig D14/250
 D619,361 S * 7/2010 Andre et al. D3/269
 D619,574 S * 7/2010 Richardson et al. D14/250
 2009/0017883 A1 1/2009 Lin
 2009/0111543 A1 4/2009 Tai et al.
 2009/0205983 A1 8/2009 Estlander
 2010/0048267 A1 2/2010 Lin
 2010/0093412 A1 4/2010 Serra et al.
 2010/0096284 A1* 4/2010 Bau 206/320
 2010/0124040 A1* 5/2010 Diebel et al. 361/816

OTHER PUBLICATIONS

EcoShield Slider for iPhone, <URL:http://www.agent18.com/productdetail/ecoshield-slider-for-iphone/136.aspx>, retrieved from internet Jul. 13, 2010.*
 Innocase II Surface Combo—Burgundy, <URL:http://www.seidionline.com/ProductDetails.asp?ProductCode=BD2%2DHLCSRIPH%2DRD>, retrieved from internet Jul. 13, 2010.*
 Review of Artwizz SeeJacket Crystal for Apple iPhone, published Nov. 29, 2007, <URL:http://www.ilounge.com/index.php/reviews/entry/artwizz-seejacket-crystal-for-apple-iphone>, retrieved from internet Jul. 13, 2010.*
 Review of Agent 18 iPhone Shield, published Jan. 4, 2008, <URL:http://www.ilounge.com/index.php/reviews/entry/agent-18-iphone-shield/>, retrieved from internet Jul. 13, 2010.*
 Review of Belkin Clear Case for iPhone, published Jan. 4, 2008, <URL:http://www.ilounge.com/index.php/reviews/entry/belkin-clear-case-for-iphone/>, retrieved from internet Jul. 13, 2010.*
 Review of BoxWave FlexiSkin for Apple iPhone, available at http://www.ilounge.com, Jul. 6, 2007 (accessed Feb. 6, 2008).
 Review of DLO Jam Jacket for iPhone, available at http://www.ilounge.com, Jul. 6, 2007 (accessed Feb. 6, 2008).
 Review of Incipio dermaSHOT Silicone Case for Apple iPhone, available at http://www.ilounge.com, Jul. 6, 2007 (accessed Feb. 6, 2008).
 Review of Marware SportGrip Smooth Silicone Protection for iPhone, available at http://www.ilounge.com, Jul. 6, 2007 (accessed Feb. 6, 2008).
 Review of Speck SkinTight 2-Pack for iPhone, available at http://www.ilounge.com, Jul. 6, 2007 (accessed Feb. 6, 2008).
 Review of Speck ToughSkin for iPhone, available at http://www.ilounge.com, Jul. 6, 2007 (accessed Feb. 6, 2008).
 Review of Belkin Acrylic Case for iPhone, available at http://www.ilounge.com, Jul. 7, 2007 (accessed Feb. 6, 2008).
 Review of Belkin Sport Armband for iPhone, available at http://www.ilounge.com, Jul. 19, 2007 (accessed Feb. 6, 2008).
 iSkin, Inc., revo for iPhone, available at http://www.iskin.com, announced Jul. 25, 2007 (accessed Feb. 6, 2008).
 The Agent 18 Eco iPhone Shield Case Review, available at http://blog.monkeykit.com, Sep. 14, 2007 (accessed Feb. 6, 2008).
 Review of CoverCase SlimSkin Silicon Case for iPhone, available at http://www.ilounge.com, Jan. 10, 2008 (accessed Feb. 6, 2008).

* cited by examiner

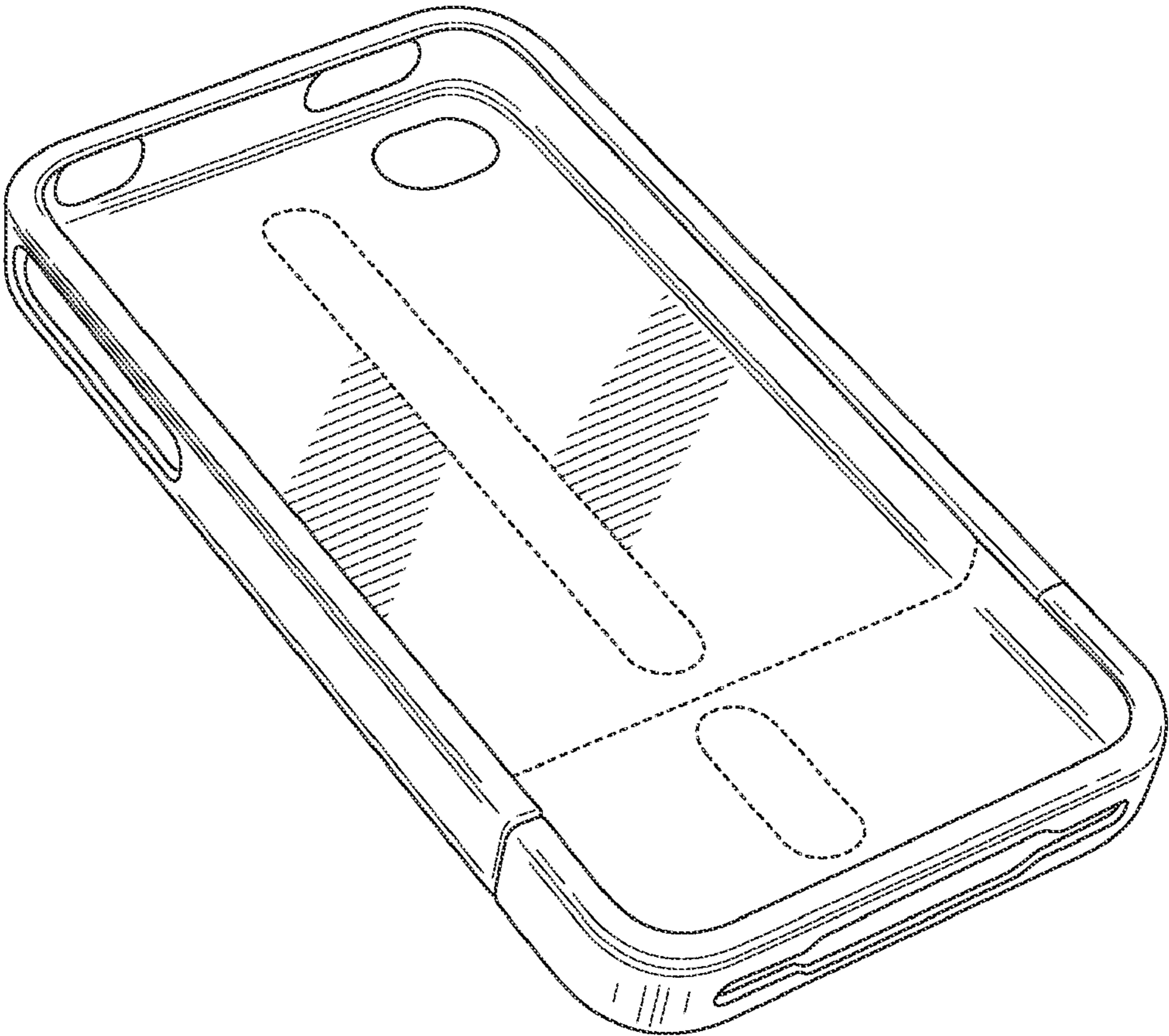

FIG. 1

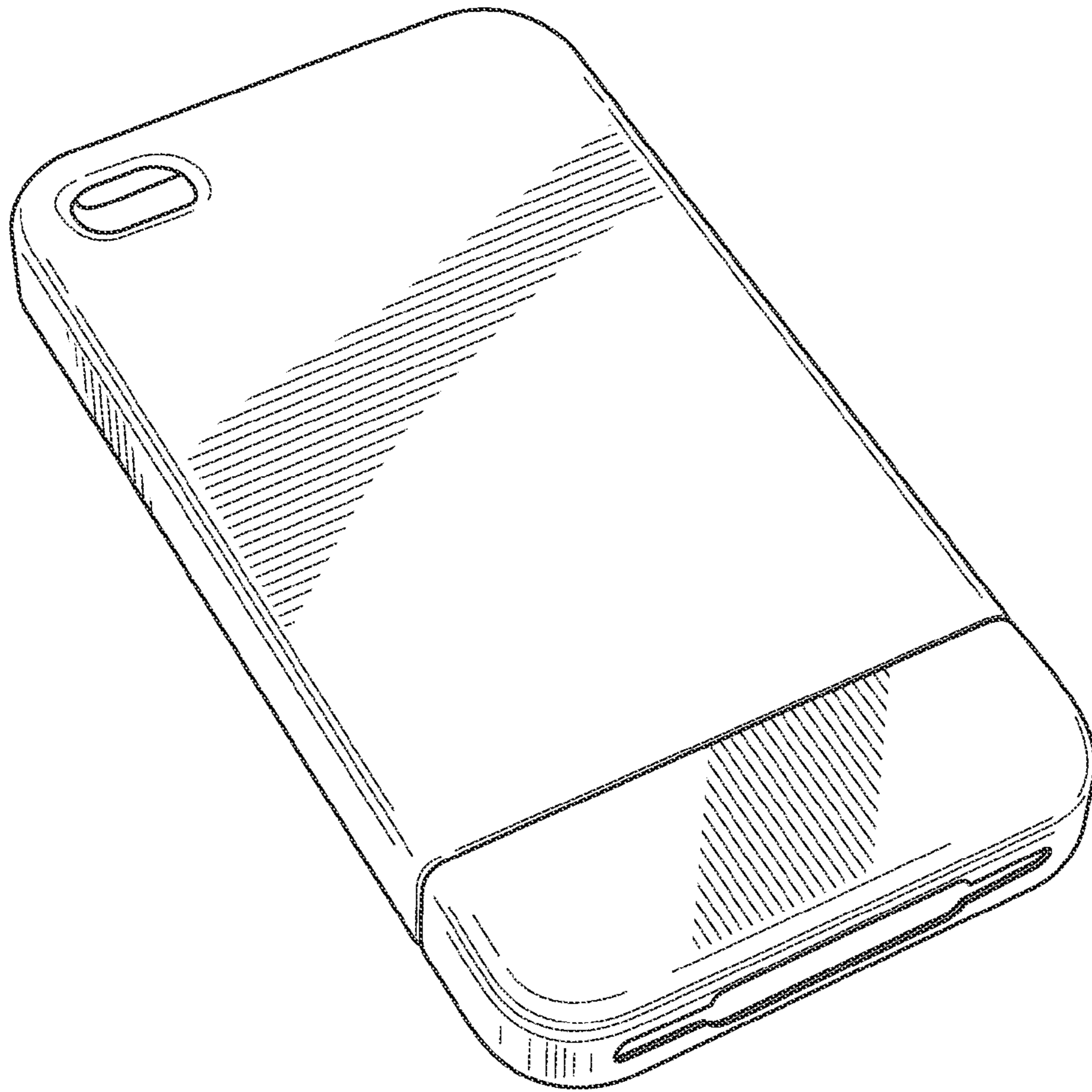

FIG. 2

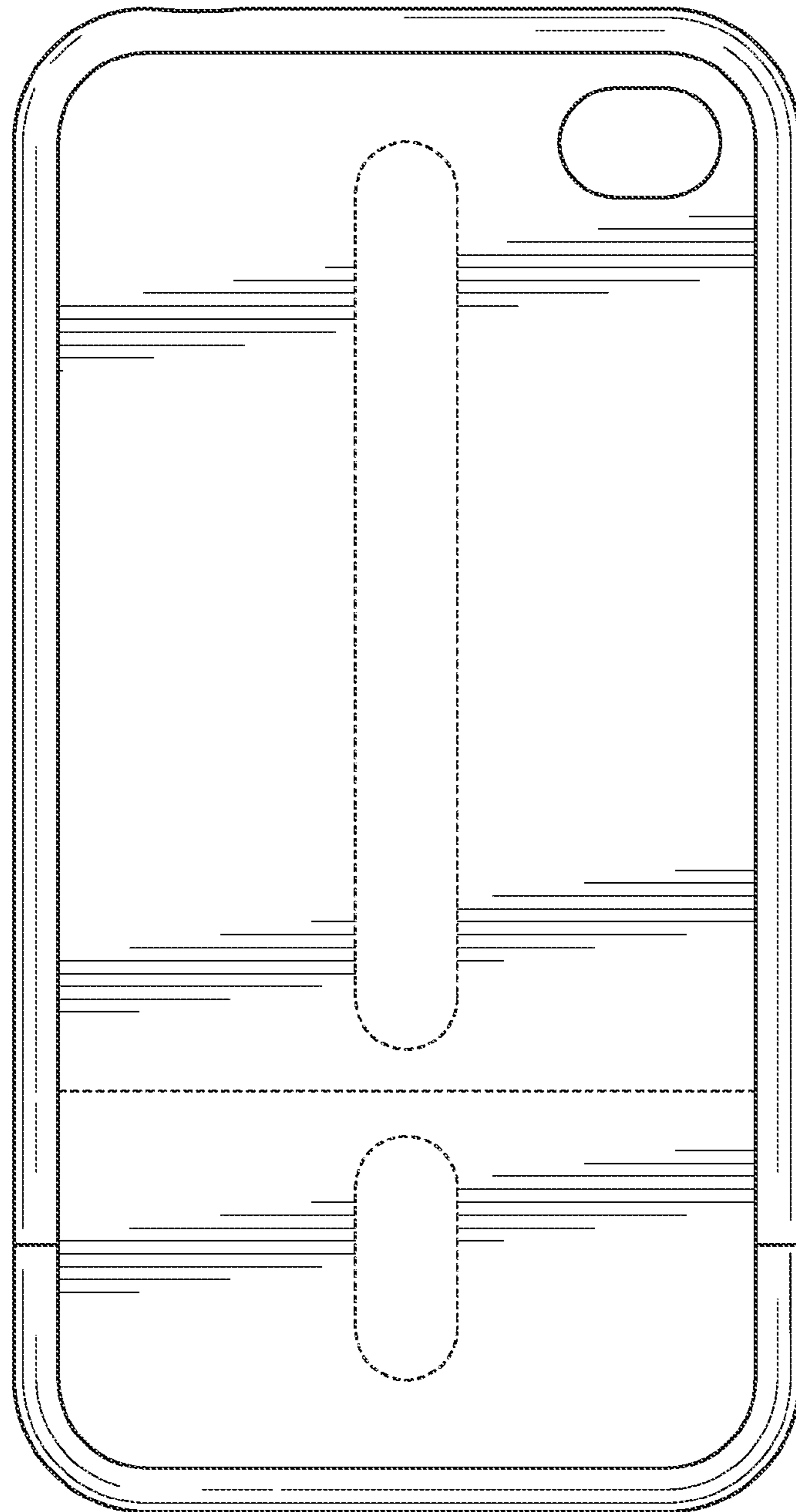

FIG. 3

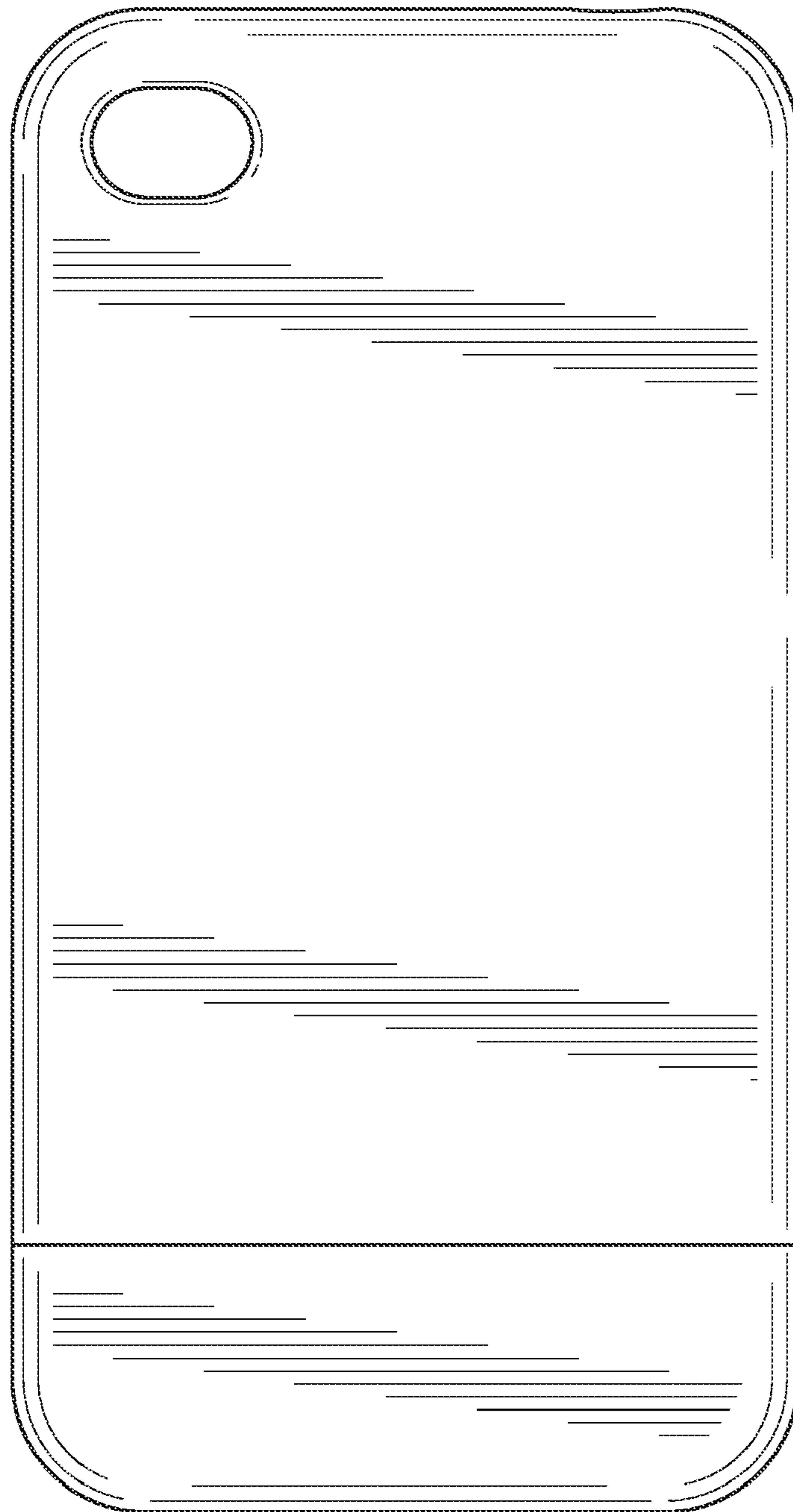

FIG. 4

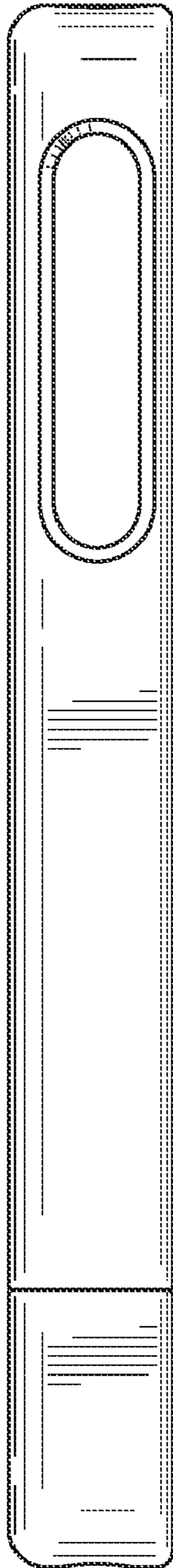

FIG. 5

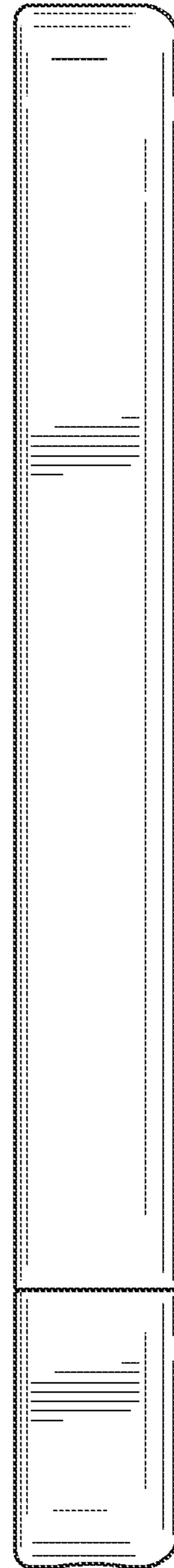

FIG. 6

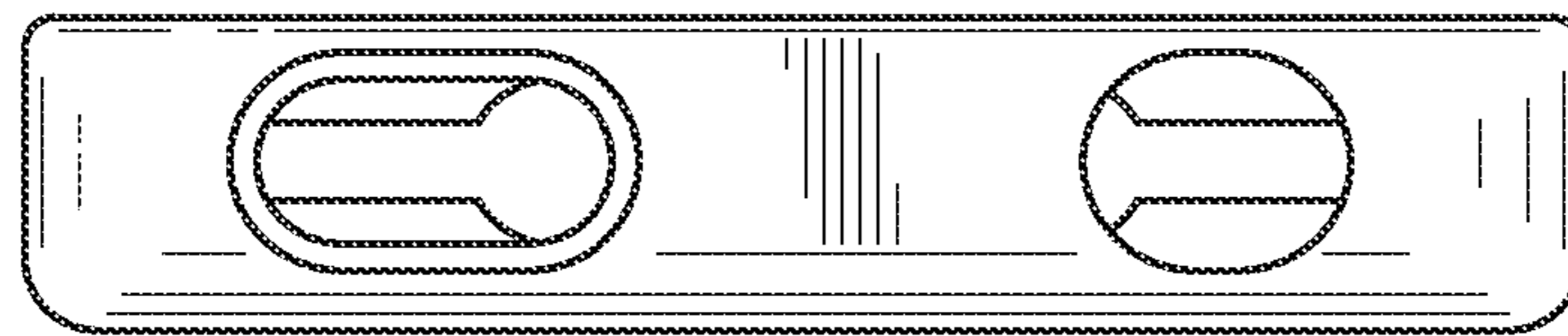

FIG. 7

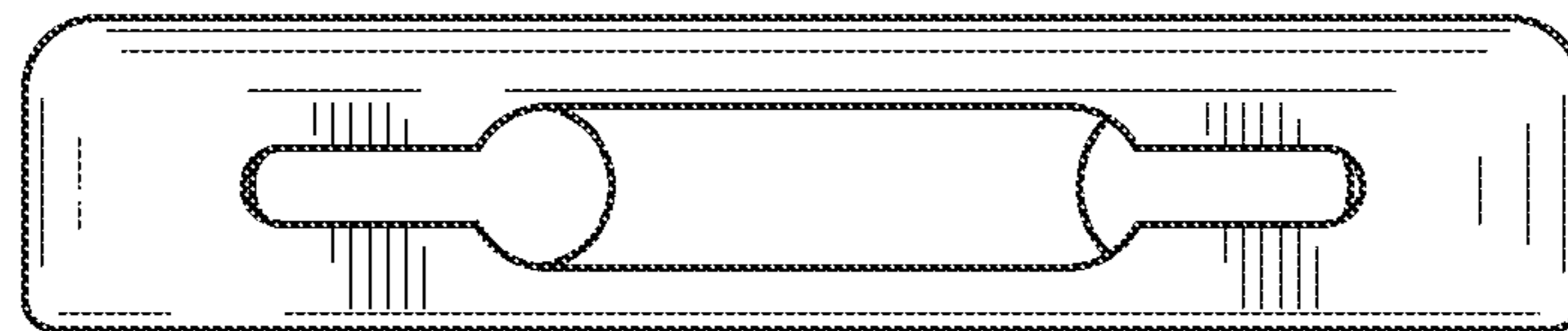

FIG. 8

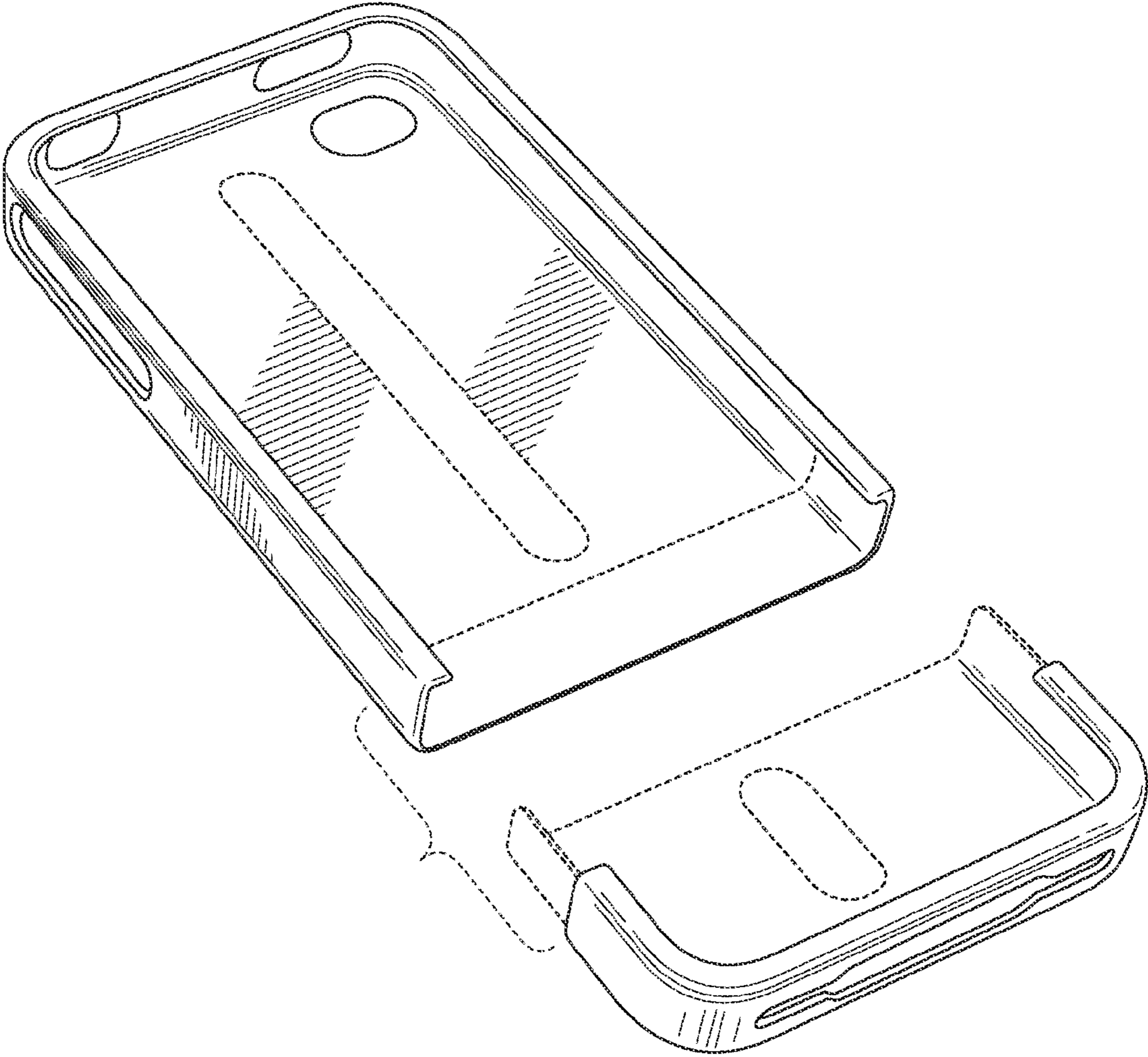

FIG. 9

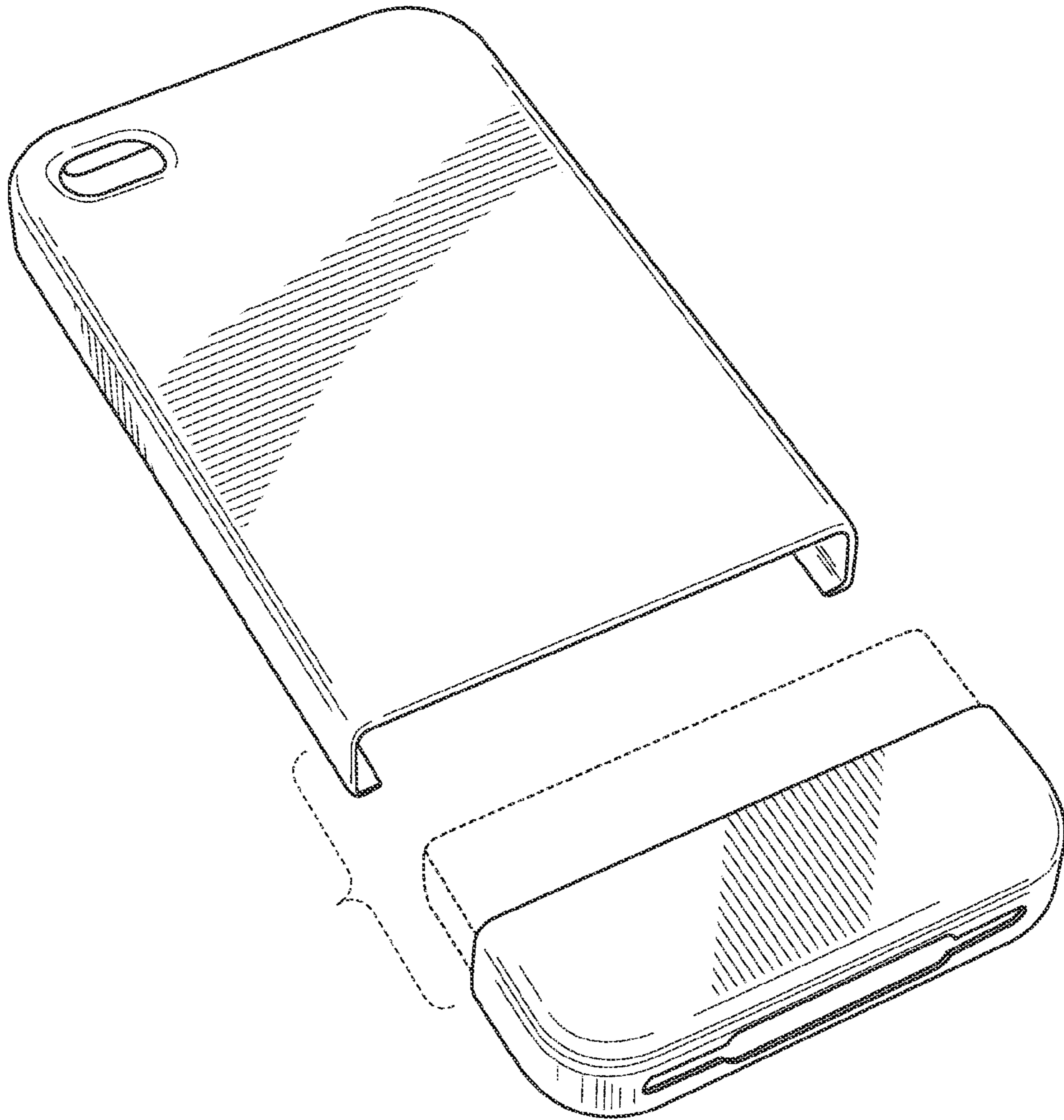

FIG. 10

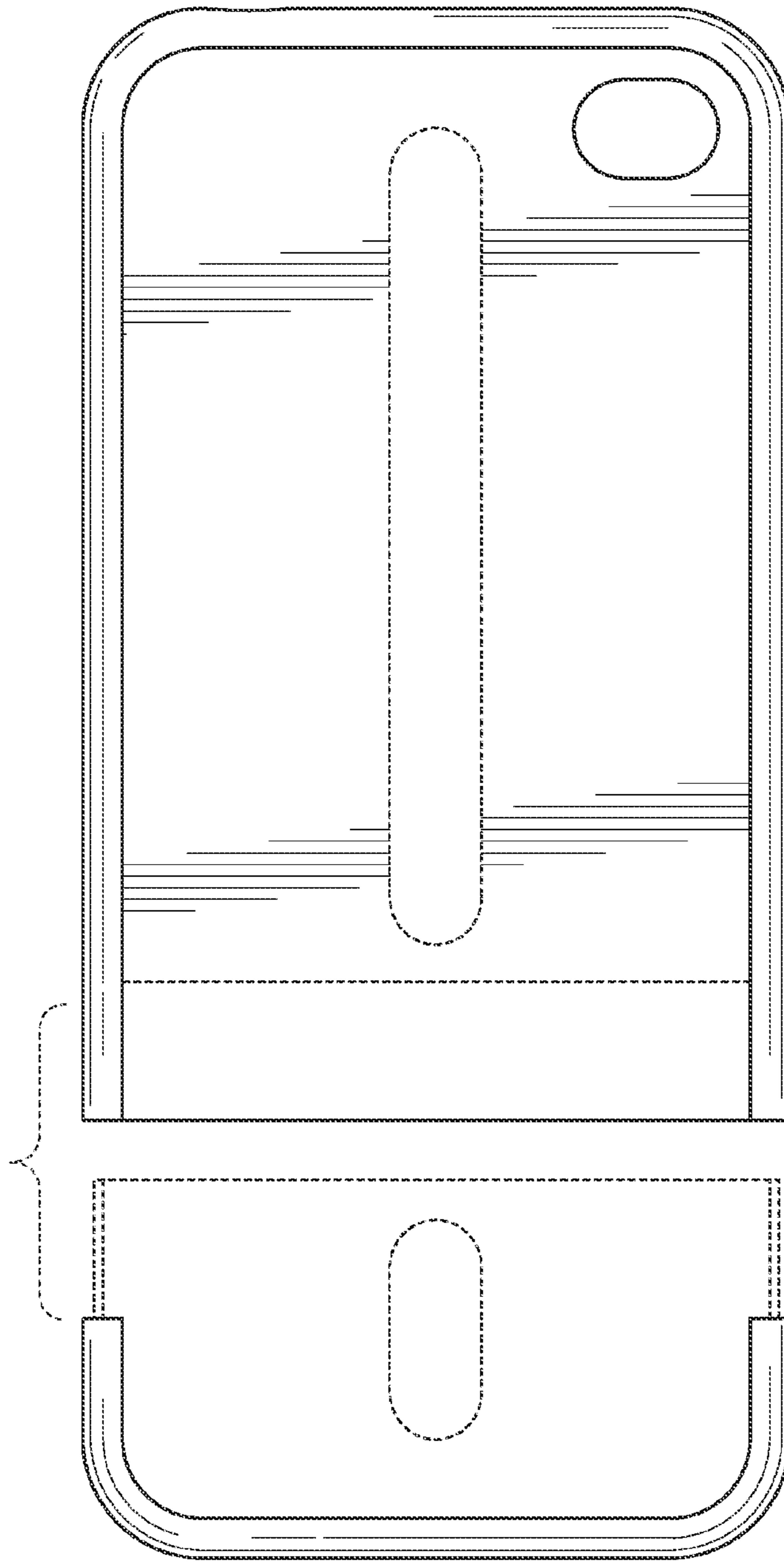

FIG. 11

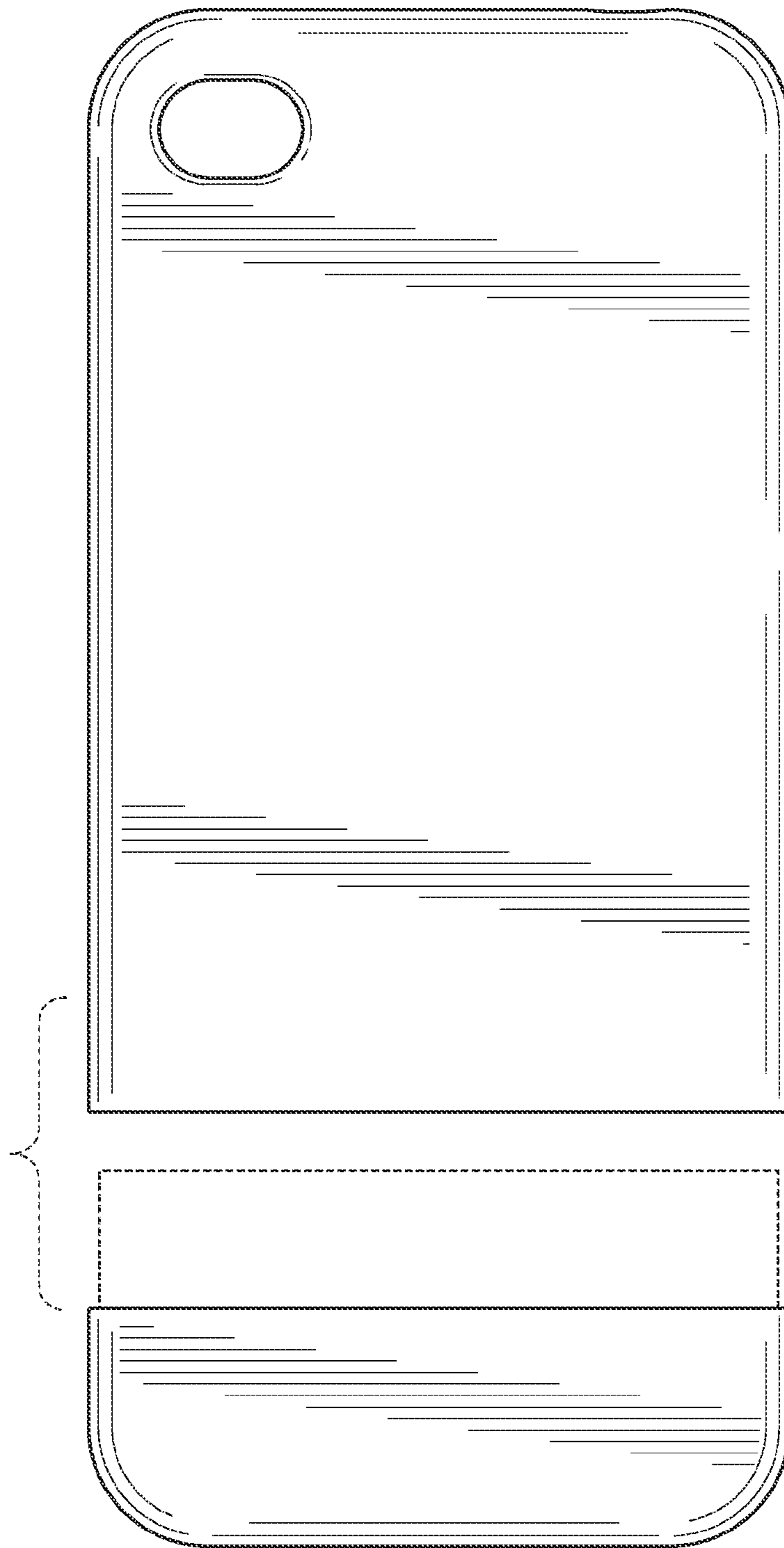

FIG. 12

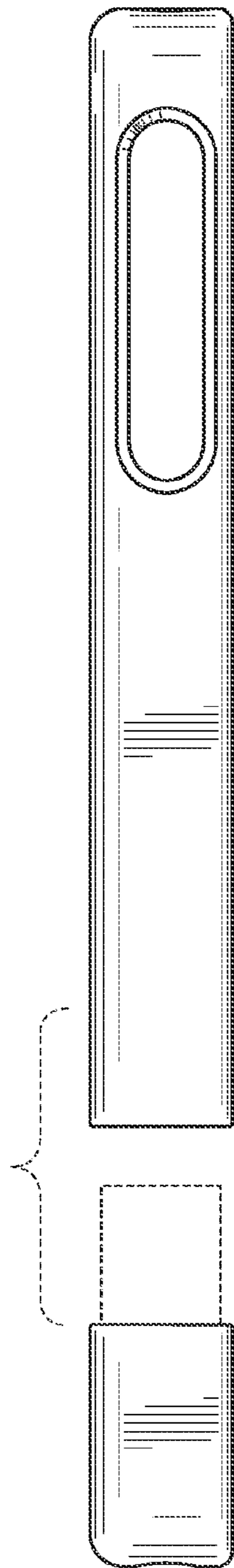

FIG. 13

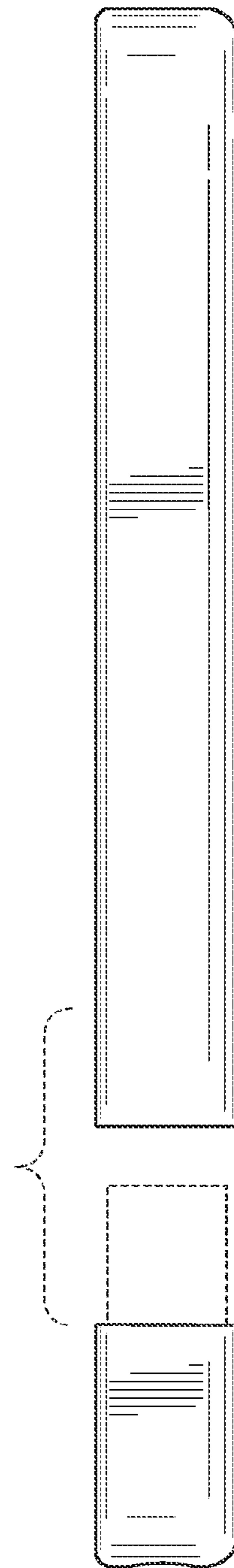

FIG. 14