



US00D623069S

(12) **United States Design Patent**
Warsaw

(10) **Patent No.:** **US D623,069 S**
(45) **Date of Patent:** **** Sep. 7, 2010**

(54) **S'MORE SHAPED CONTAINER**

(57) **CLAIM**

(76) **Inventor:** **Michael V. Warsaw**, 10780 Fox ave.,
North Collins, NY (US) 14111

What is claimed is the ornamental design for a s'more shaped container, as shown and described.

(**) **Term:** **14 Years**

(21) **Appl. No.:** **29/346,706**

DESCRIPTION

(22) **Filed:** **Nov. 4, 2009**

(51) **LOC (9) Cl.** **09-01**

(52) **U.S. Cl.** **D9/643; D9/432; D7/628**

(58) **Field of Classification Search** **D1/102,**
D1/105, 128; D3/270-271.1, 273, 313; D7/613-614,
D7/628; D9/600, 643, 737, 759-761, 414,
D9/432; D19/75, 92; 206/457, 527
See application file for complete search history.

FIG. 1 is an exploded perspective view of a s'more shaped container, showing a lid and a container of the new design;

FIG. 2 is a perspective view thereof;

FIG. 3 is a top plan view thereof;

FIG. 4 is a bottom plan view thereof;

FIG. 5 is a rear elevational view thereof;

FIG. 6 is a right-side elevational view thereof;

FIG. 7 is a left-side elevational view thereof;

FIG. 8 is a front elevational view thereof;

FIG. 9 is a top plan view of the container thereof;

FIG. 10 is a bottom plan view of the lid thereof; and,

FIG. 11 is a perspective view of the container thereof.

The broken lines showing marshmallows, graham crackers and chocolate in FIG. 1 are included for the purpose of illustrating the invention in use, and form no part of the claimed design.

(56) **References Cited**

U.S. PATENT DOCUMENTS

D309,981 S *	8/1990	French et al.	D19/75
D420,286 S *	2/2000	Simburger et al.	D9/432
D522,376 S *	6/2006	Hales	D9/414
D593,325 S *	6/2009	Evans	D3/313

* cited by examiner

Primary Examiner—Sandra Morris

(74) *Attorney, Agent, or Firm*—QuickPatents, Inc.; Kevin Prince

1 Claim, 5 Drawing Sheets

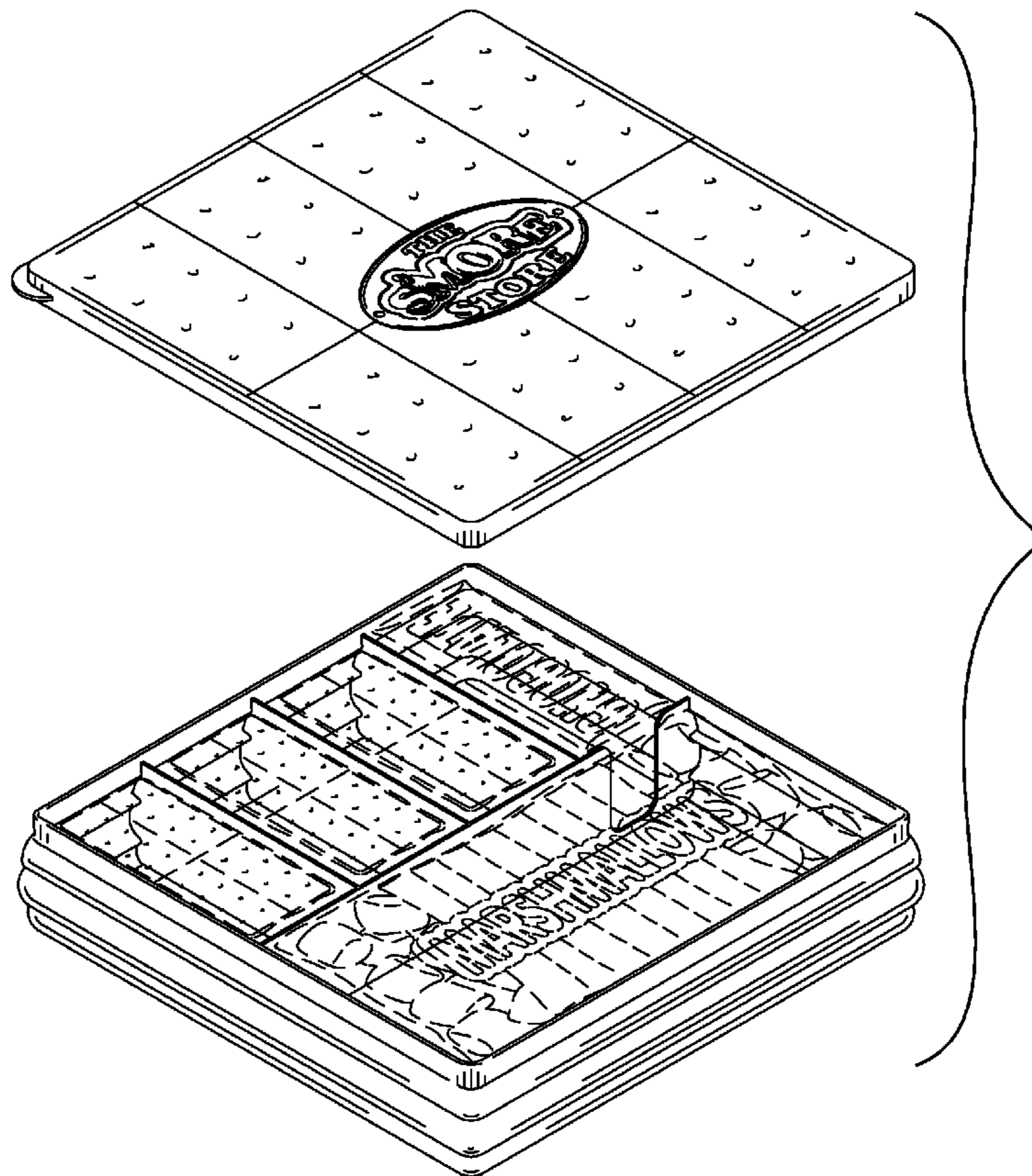

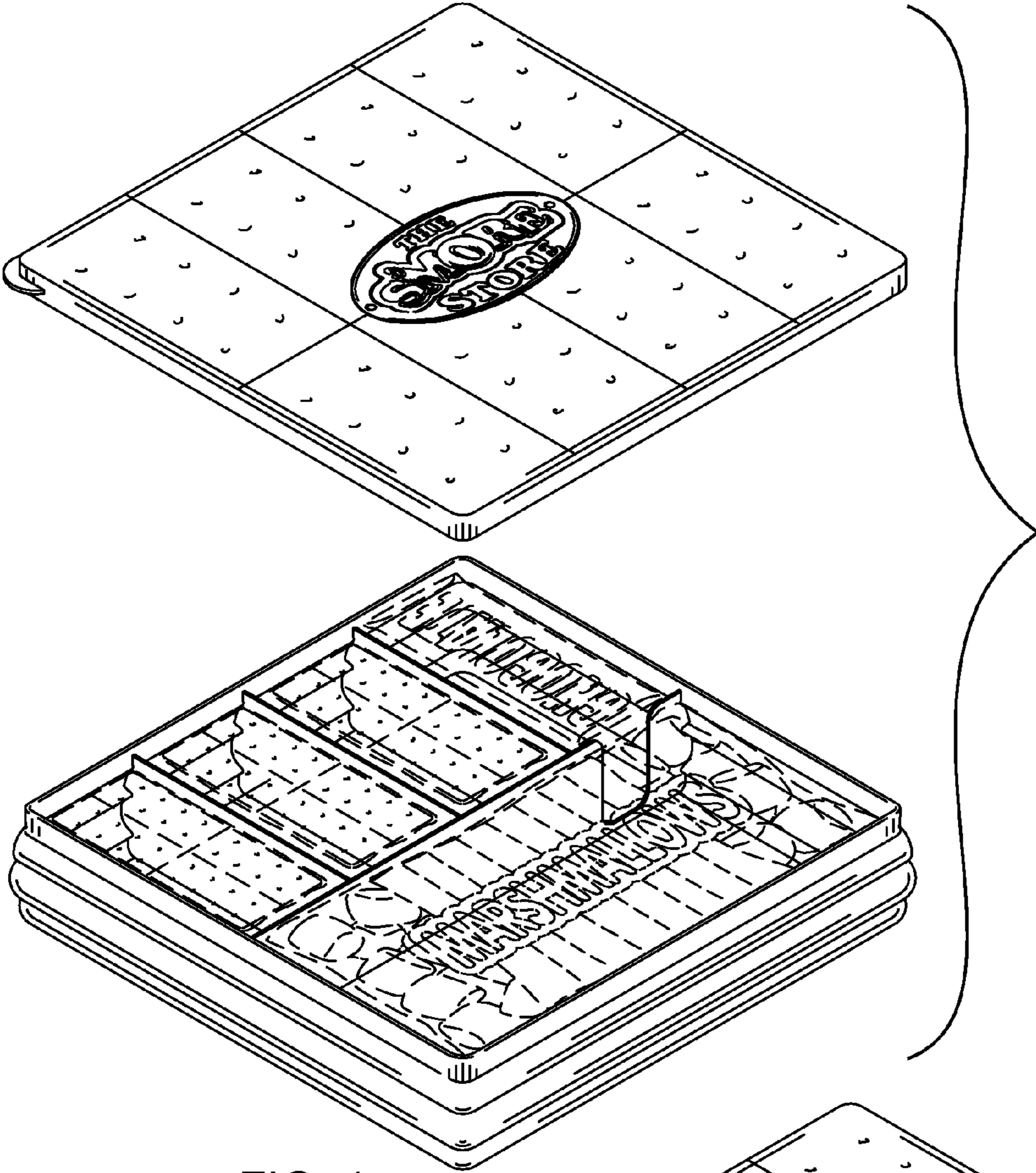

FIG. 1

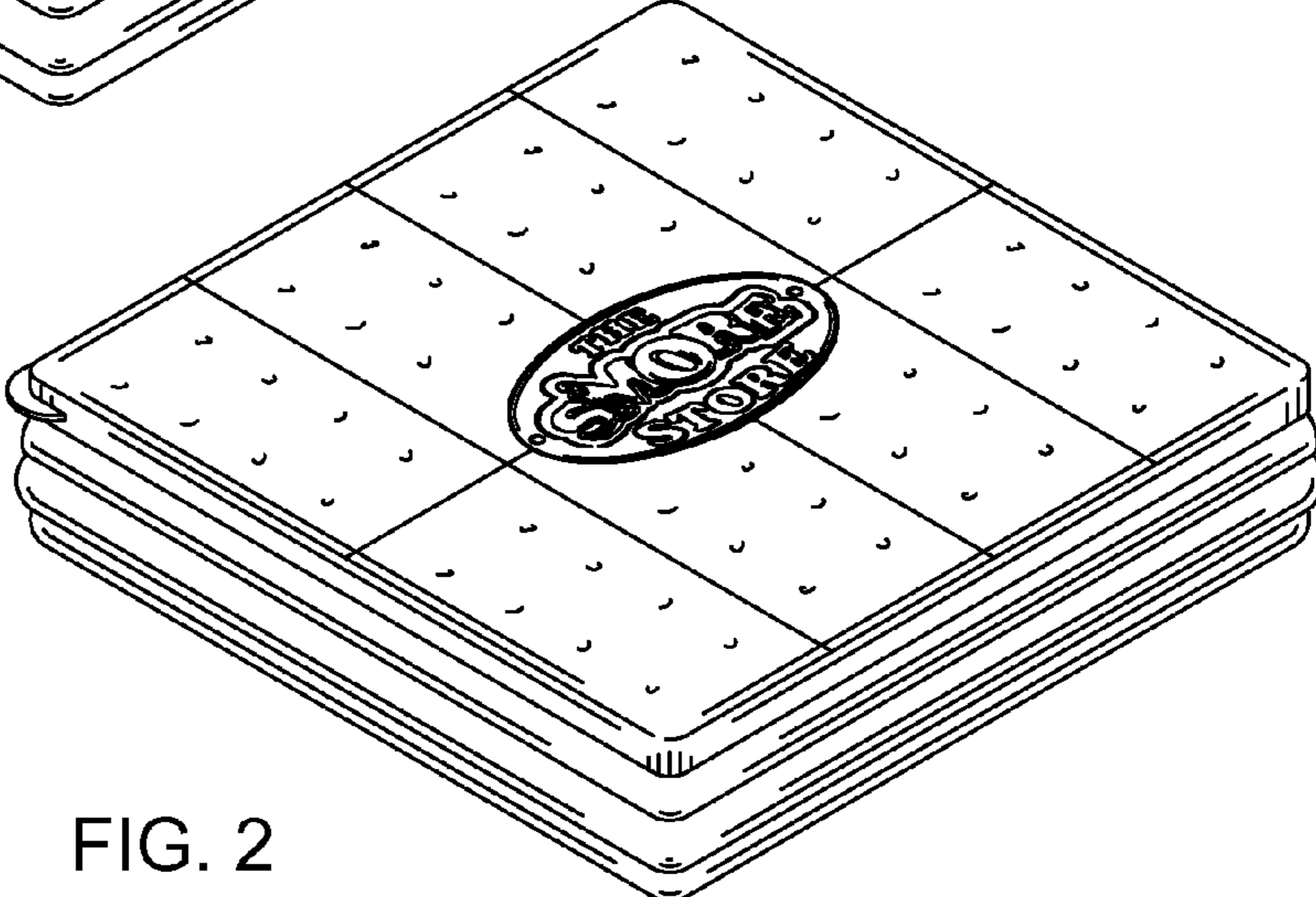

FIG. 2

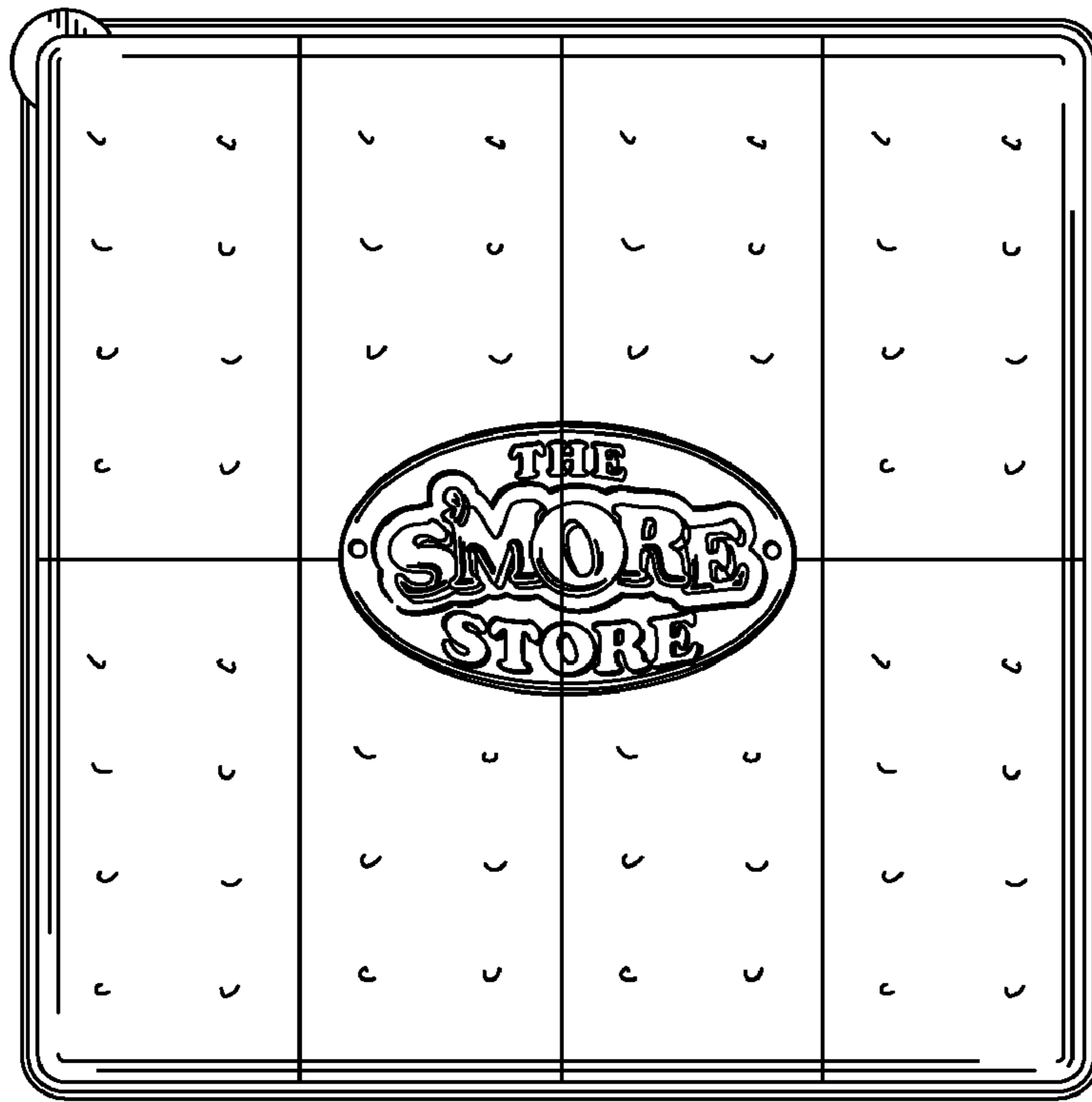

FIG. 3

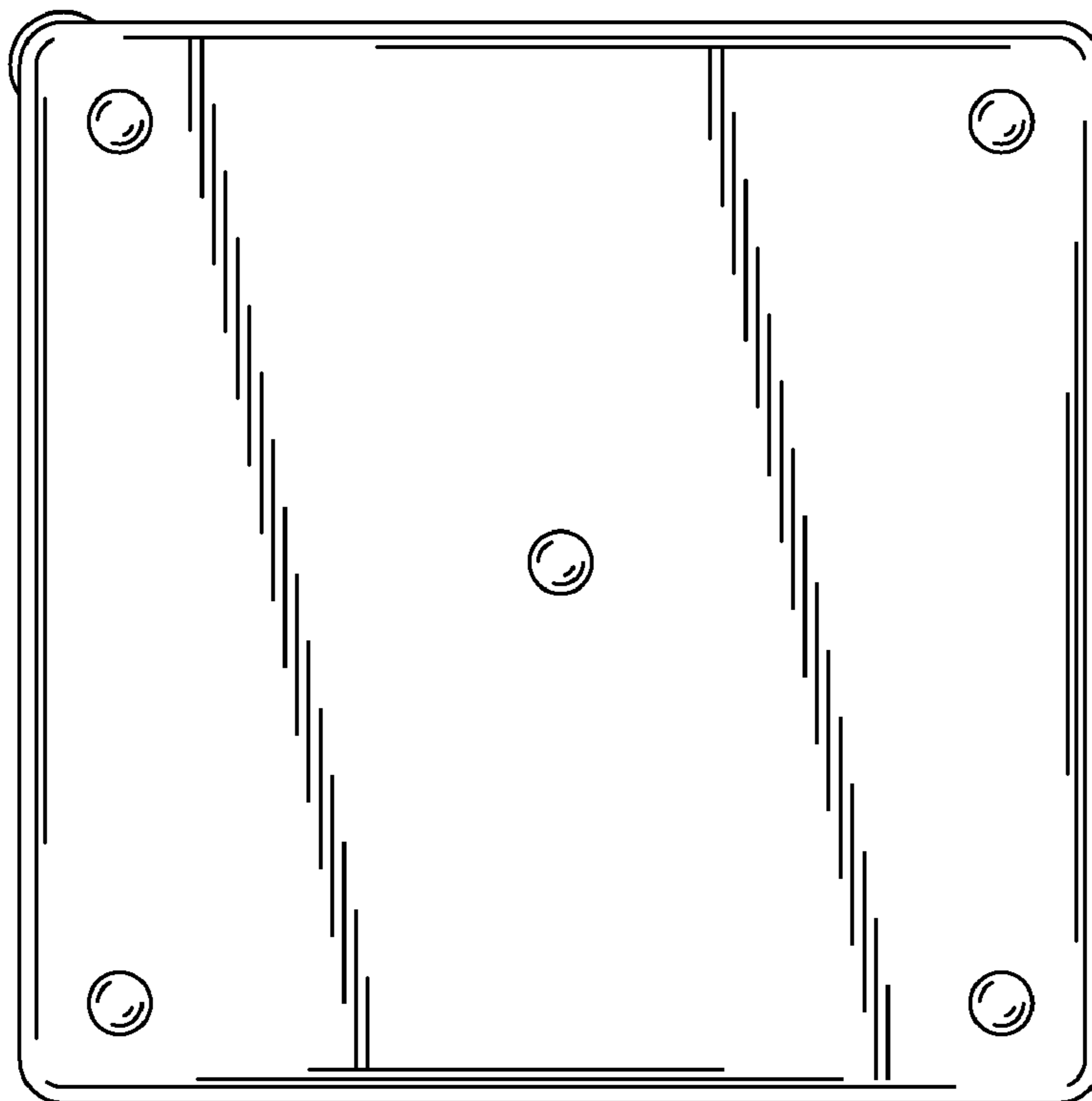

FIG. 4



FIG. 5



FIG. 6

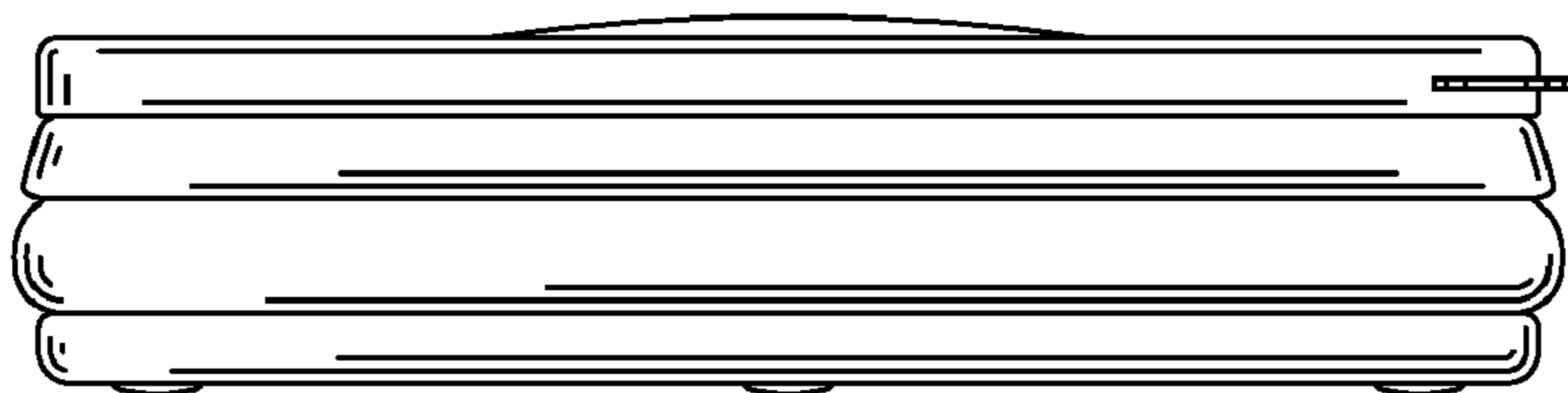

FIG. 7

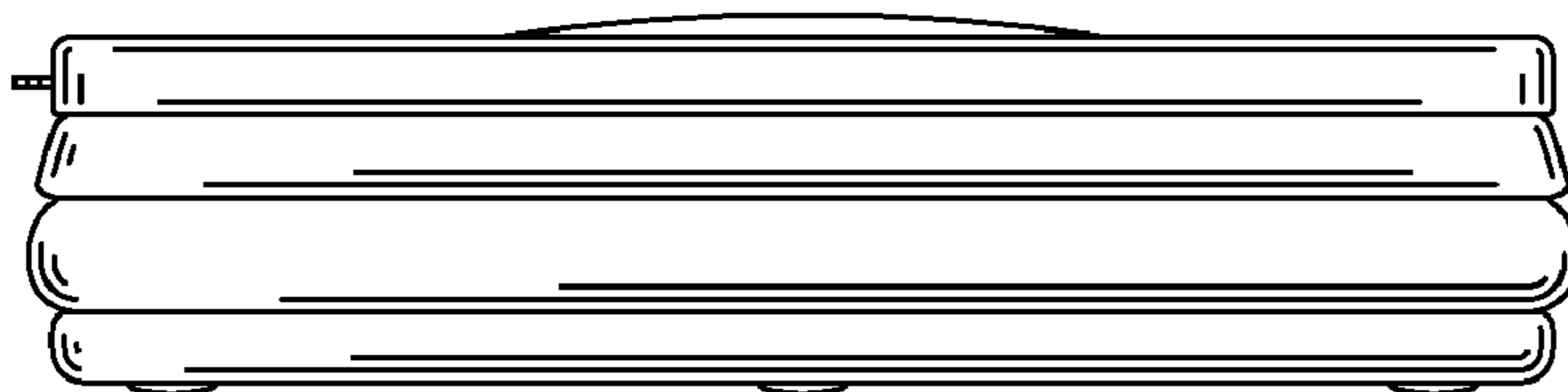

FIG. 8

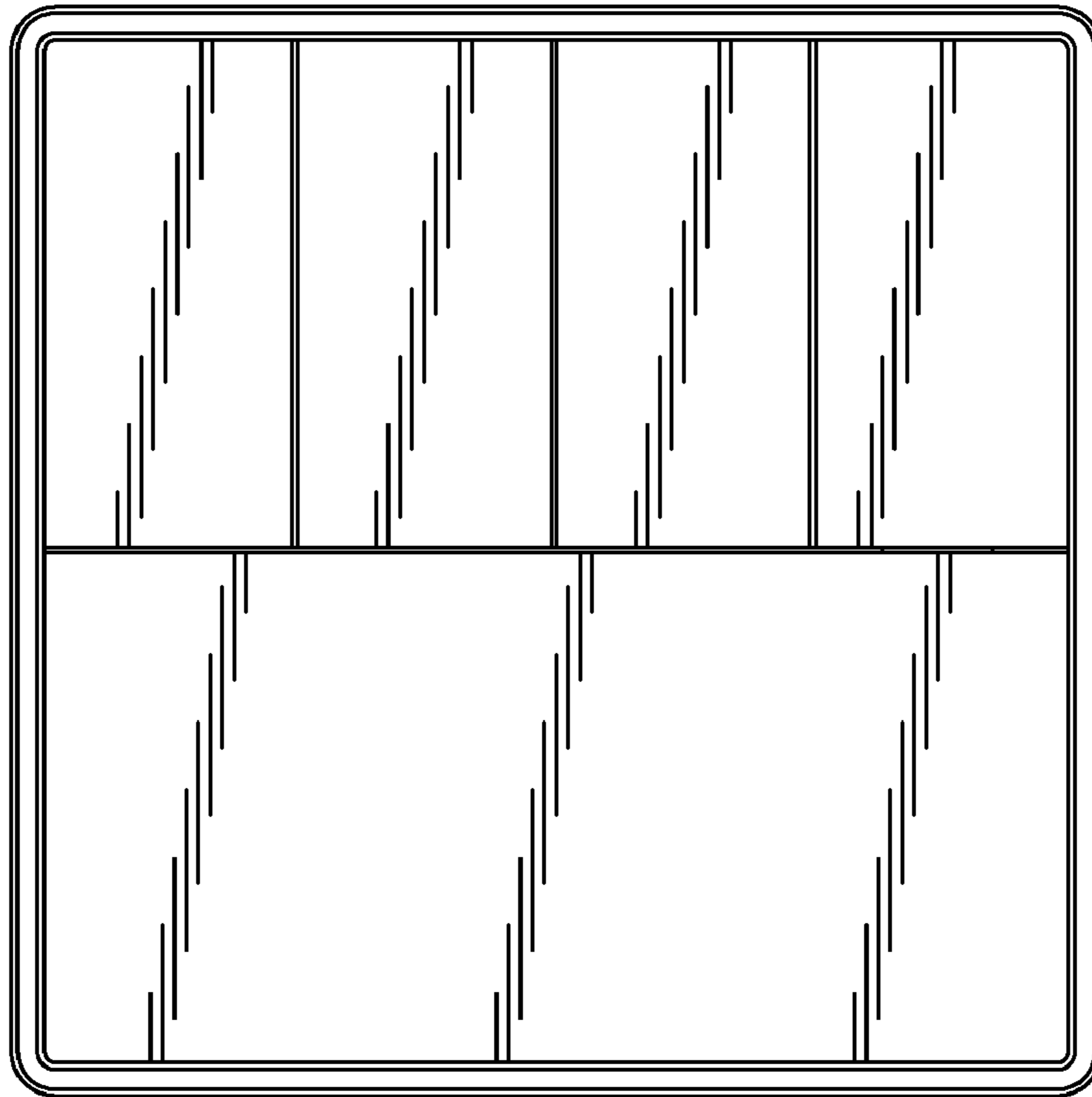

FIG. 9

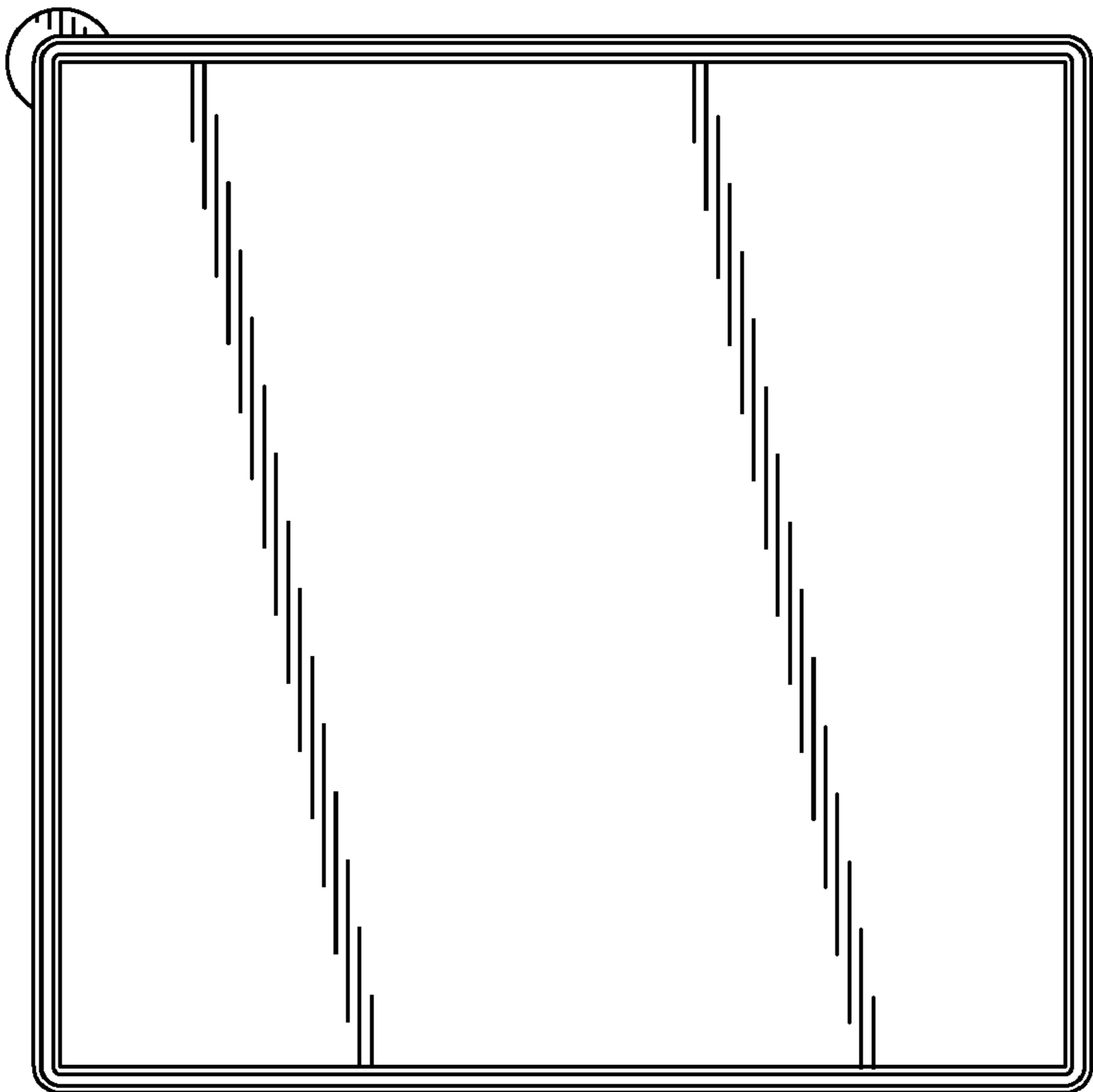

FIG. 10

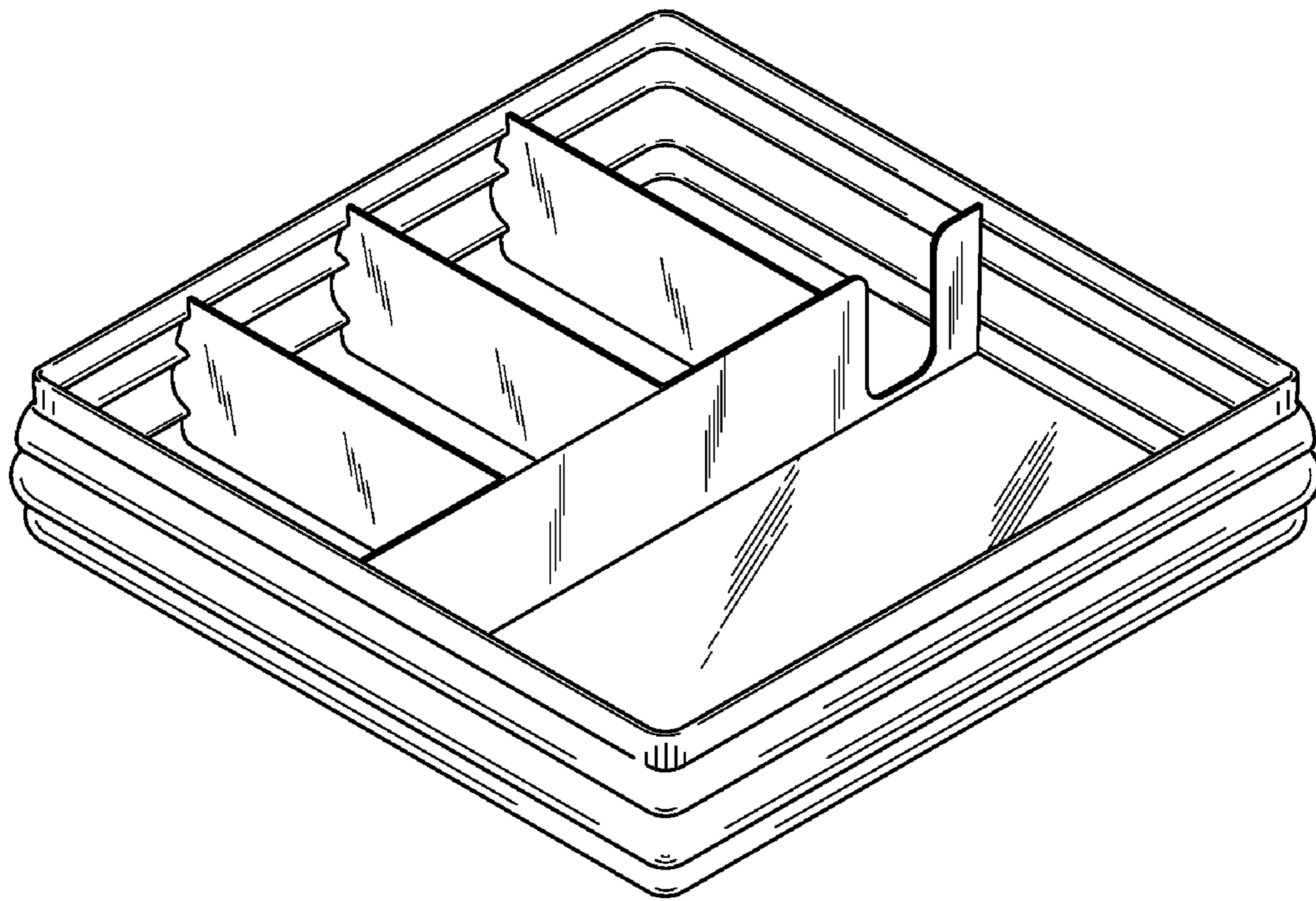

FIG. 11