



US00D623054S

(12) **United States Design Patent**  
**Eason et al.**

(10) **Patent No.:** **US D623,054 S**  
(45) **Date of Patent:** **\*\* Sep. 7, 2010**

(54) **DISPENSER**

(75) Inventors: **Stephen William Eason**, RedgraveDiss (GB); **Roger William Clarke**, Histon (GB)

(73) Assignee: **Vectura Delivery Devices Limited**, Chippenham (GB)

(\*\*) Term: **14 Years**

(21) Appl. No.: **29/274,463**

(22) Filed: **Apr. 26, 2007**

**Related U.S. Application Data**

(63) Continuation-in-part of application No. 29/268,017, filed on Oct. 27, 2006.

(30) **Foreign Application Priority Data**

Apr. 28, 2006 (EM) ..... 000521315

(51) **LOC (9) Cl.** ..... **09-03**

(52) **U.S. Cl.** ..... **D9/421; D9/730; D24/110**

(58) **Field of Classification Search** ..... D9/730, D9/731, 732, 414, 417, 419, 420, 421, 529, D9/567; D19/35, 41, 67-69; D28/66; D24/107, D24/108, 110, 121, 133, 145, 188, 231; 206/210, 206/222, 216, 225, 229, 363, 390, 409, 438, 206/570, 572, 820, 828; 128/200.11-200.23, 128/203.15, 203.21

See application file for complete search history.

(56) **References Cited**

**U.S. PATENT DOCUMENTS**

5,165,391 A \* 11/1992 Chiesi et al. .... 128/200.23

(Continued)

**FOREIGN PATENT DOCUMENTS**

EM 000014782-0002 \* 4/2003

(Continued)

**OTHER PUBLICATIONS**

Taiwan Search Report date of completion Mar. 16, 2007.

*Primary Examiner*—Catherine Tuttle

(74) *Attorney, Agent, or Firm*—Venable LLP; Robert Kinberg; Kyle D. Petaja

(57) **CLAIM**

The ornamental design for a dispenser, as shown and described.

**DESCRIPTION**

The file of this patent contains at least one drawing/photograph executed in color. Copies of this patent with color drawing(s)/photograph(s) will be provided by the Office upon request and payment of the necessary fee.

FIG. 1 is a front view of the first embodiment;  
FIG. 2 is a back view of the first embodiment;  
FIG. 3 is a left view of the first embodiment;  
FIG. 4 is a right view of the first embodiment;  
FIG. 5 is a top view of the first embodiment;  
FIG. 6 is a bottom view of the first embodiment;  
FIG. 7 is a front view of the second embodiment;  
FIG. 8 is a back view of the second embodiment;  
FIG. 9 is a left view of the second embodiment;  
FIG. 10 is a right view of the second embodiment;  
FIG. 11 is a top view of the second embodiment; and,  
FIG. 12 is a bottom view of the second embodiment.

The stippled shading in the drawings indicates translucent areas.

The broken lines are included for the purpose of illustrating a portion of the dispenser that forms no part of the claimed design.

**1 Claim, 12 Drawing Sheets**  
**(6 of 12 Drawing Sheet(s) Filed in Color)**

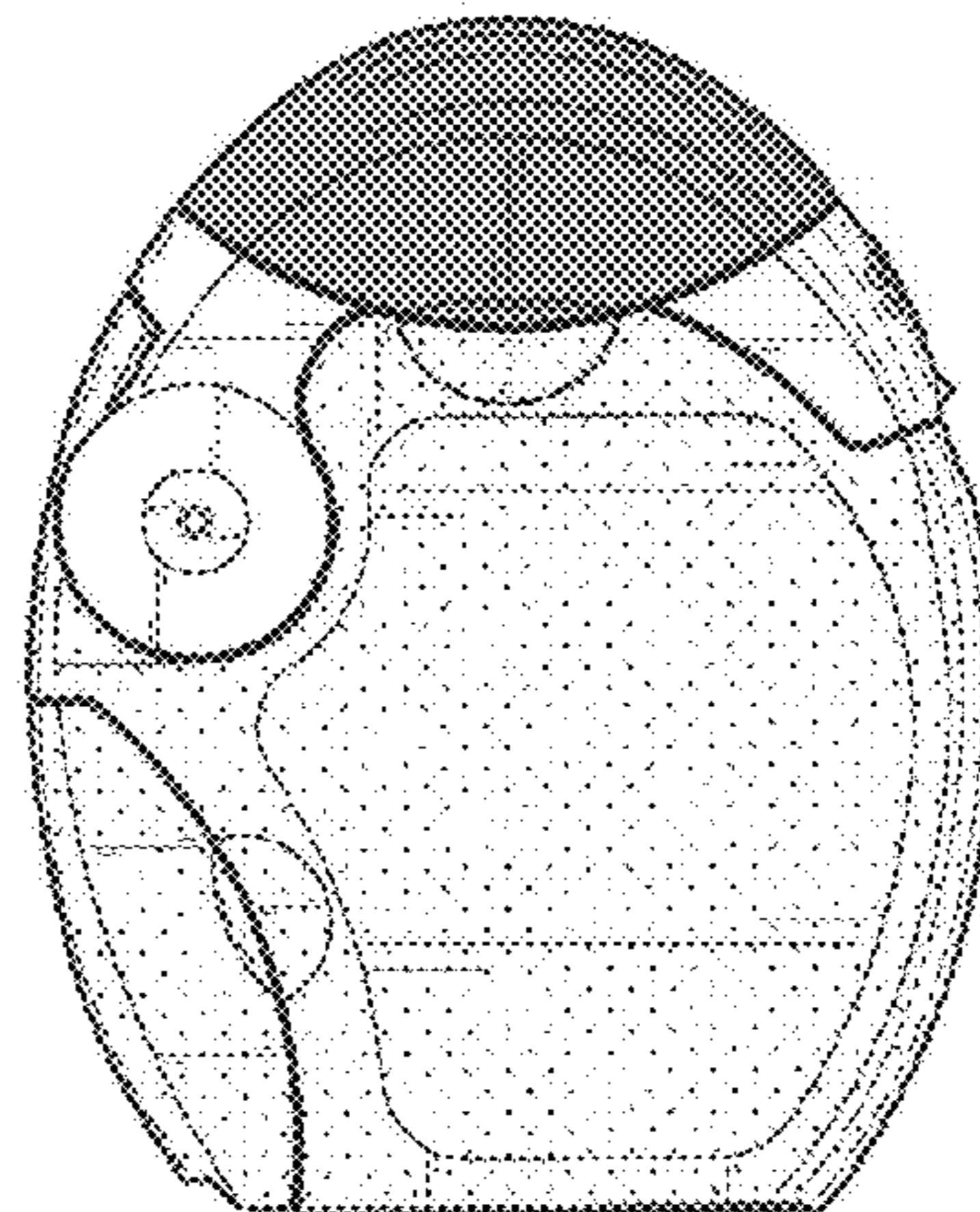
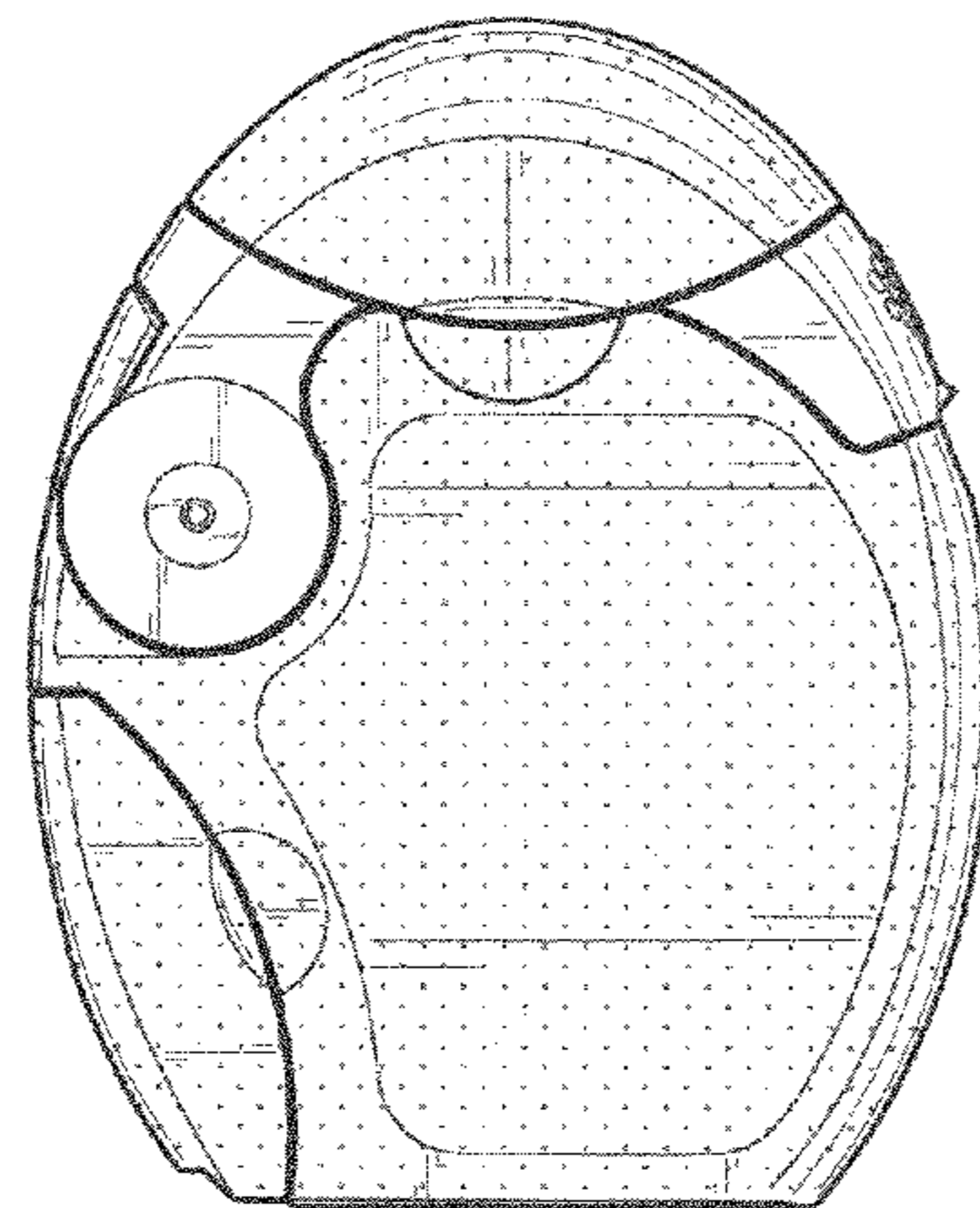

# US D623,054 S

Page 2

## U.S. PATENT DOCUMENTS

D452,910 S \* 1/2002 Braithwaite et al. .... D24/110  
D498,415 S \* 11/2004 Schuller et al. .... D9/686  
D499,802 S \* 12/2004 Pinon et al. .... D24/110  
7,107,988 B2 \* 9/2006 Pinon et al. .... 128/203.15  
D550,350 S \* 9/2007 Clarke et al. .... D24/110  
D560,793 S \* 1/2008 Pearl et al. .... D24/110  
D564,087 S \* 3/2008 Yodfat et al. .... D24/108  
D569,967 S \* 5/2008 Pearl et al. .... D24/110  
2006/0107949 A1 \* 5/2006 Davies et al. .... 128/200.23  
2006/0157053 A1 \* 7/2006 Barney et al. .... 128/200.23  
2006/0196504 A1 \* 9/2006 Augustyn et al. .... 128/203.15  
2007/0137645 A1 \* 6/2007 Eason et al. .... 128/203.15  
2007/0181123 A1 \* 8/2007 Houzego ..... 128/203.15

## FOREIGN PATENT DOCUMENTS

EM 000014782-0003 \* 4/2003

EM 000014782-0004 \* 4/2003  
EM 000014782-0005 \* 4/2003  
EM 000014782-0006 \* 4/2003  
EM 000281316-0002 \* 1/2005  
GB DES. 1044214 \* 8/1987  
GB DES. 3007821 \* 10/2002  
GB DES. 3007822 \* 10/2002  
GB DES. 3009649 \* 12/2002  
JP D1213934 6/2004  
KR 30-1992-0000433 1/1992  
KR 30-2004-0003019 2/2004  
TW 401169 5/1987  
TW D103462 3/2005  
TW D103812 3/2005  
WO DM/053443 \* 10/2000

\* cited by examiner

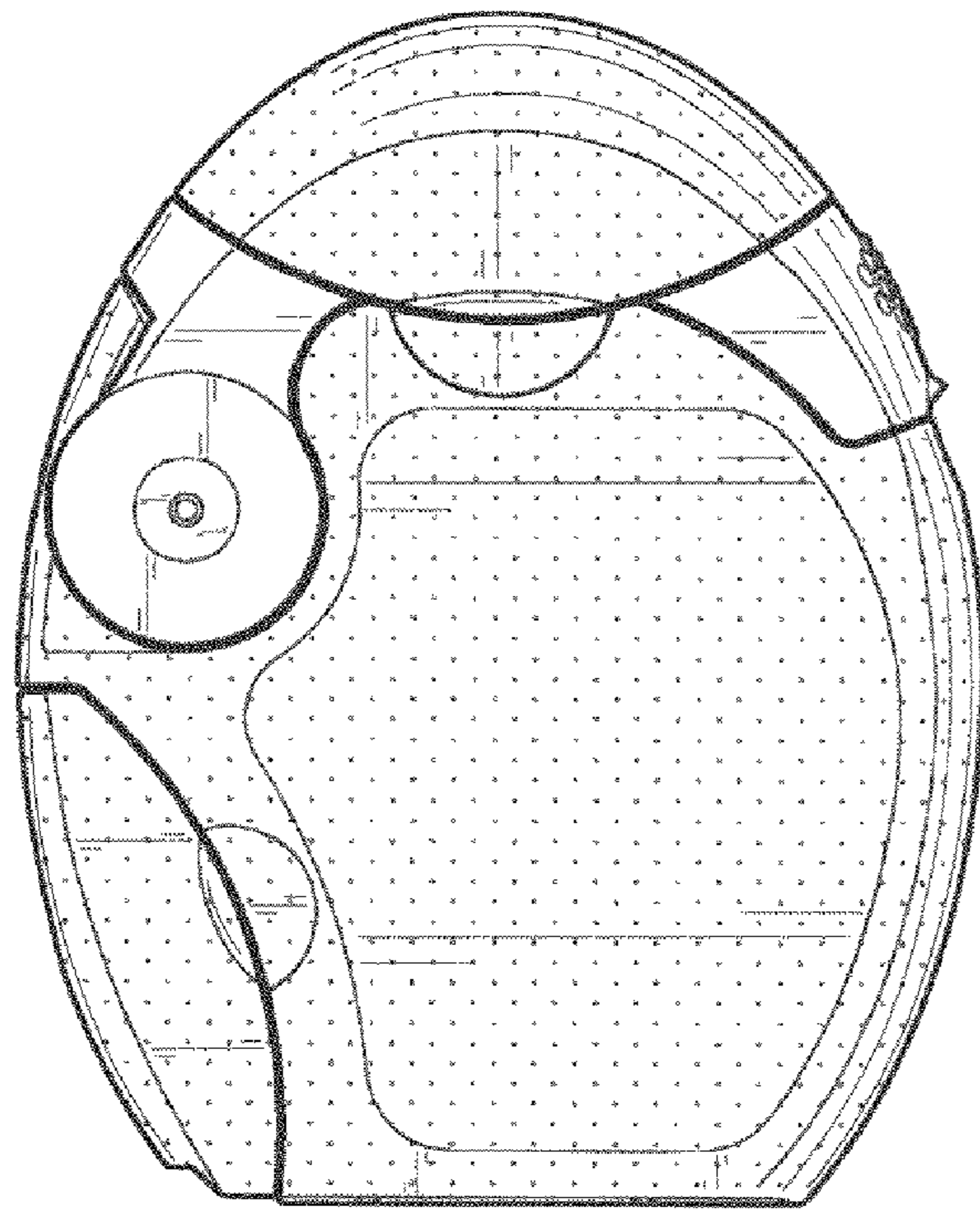

FIG. 1

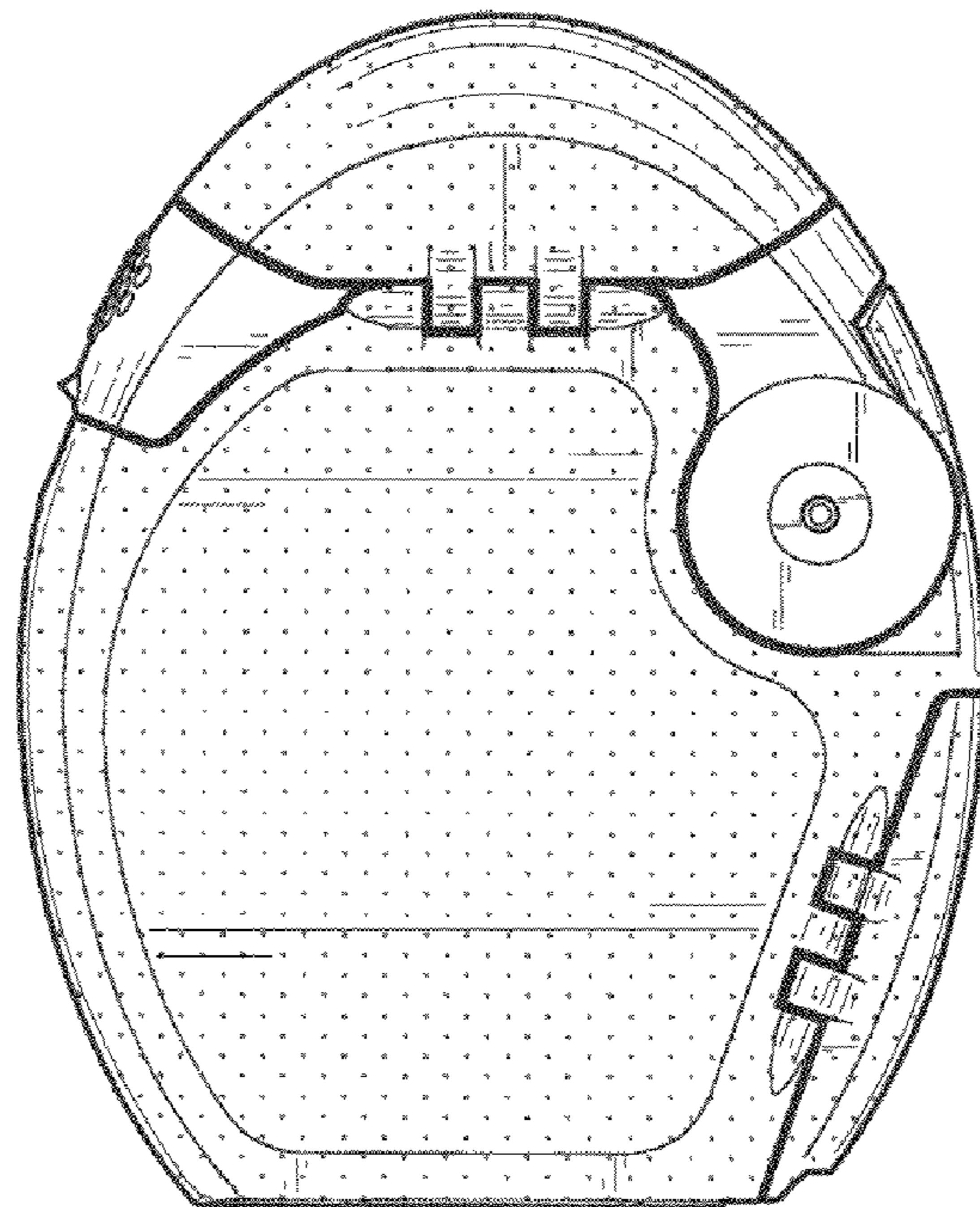

FIG. 2

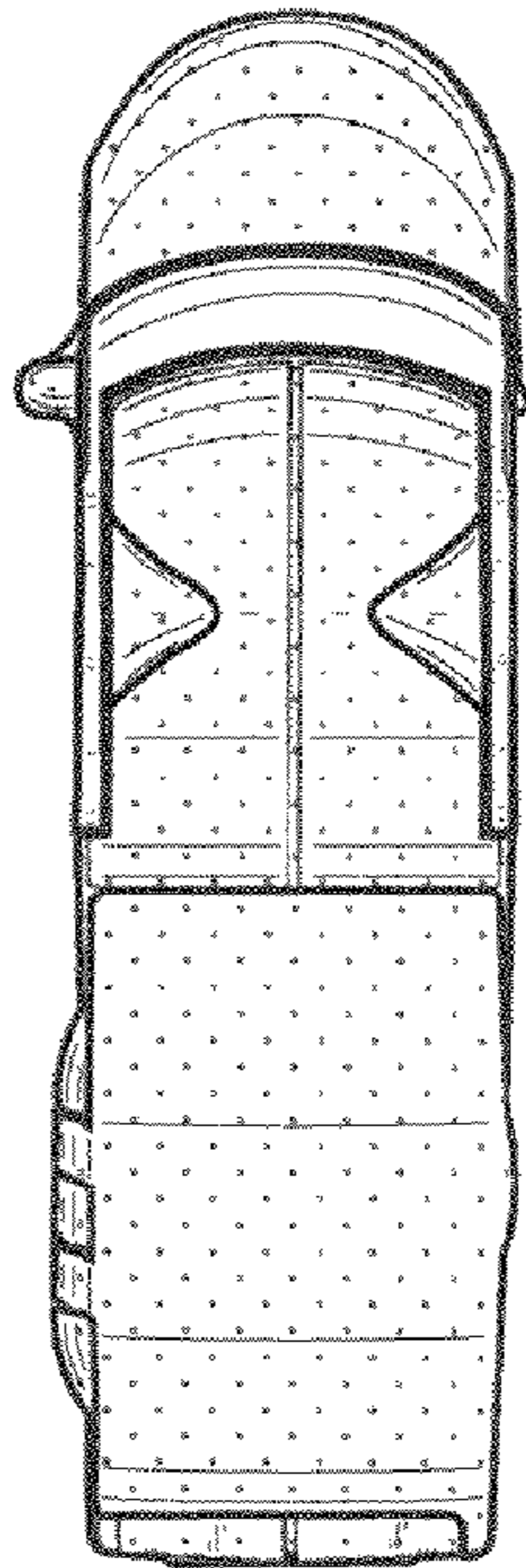

FIG. 3

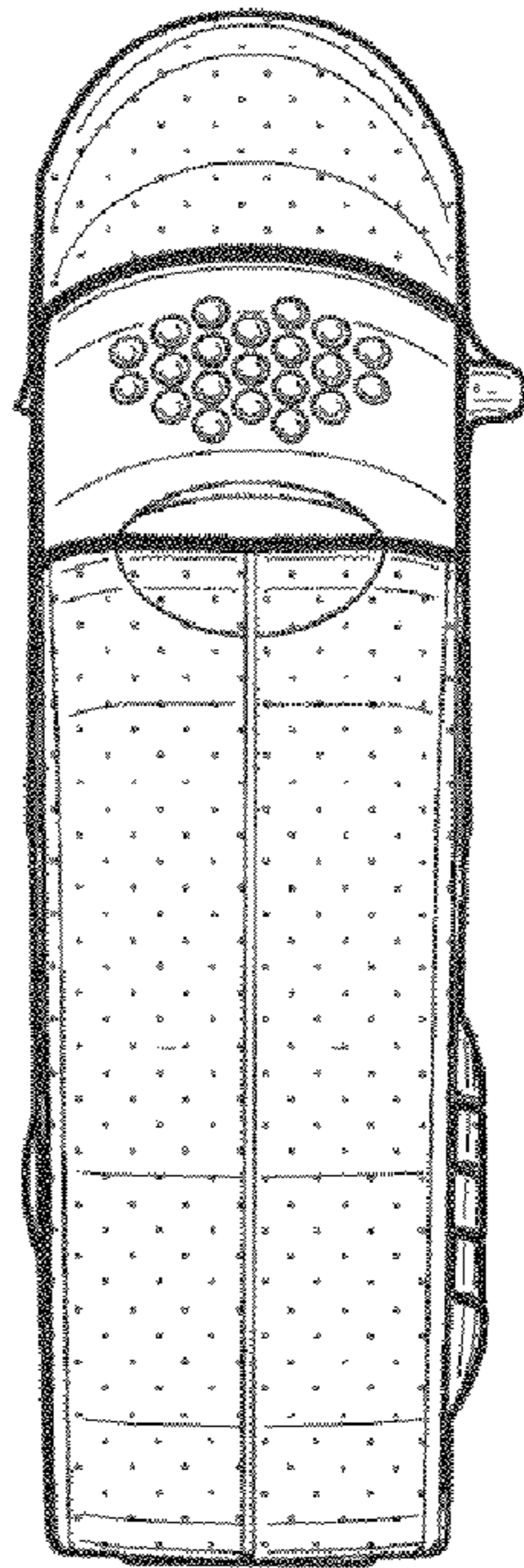

FIG. 4

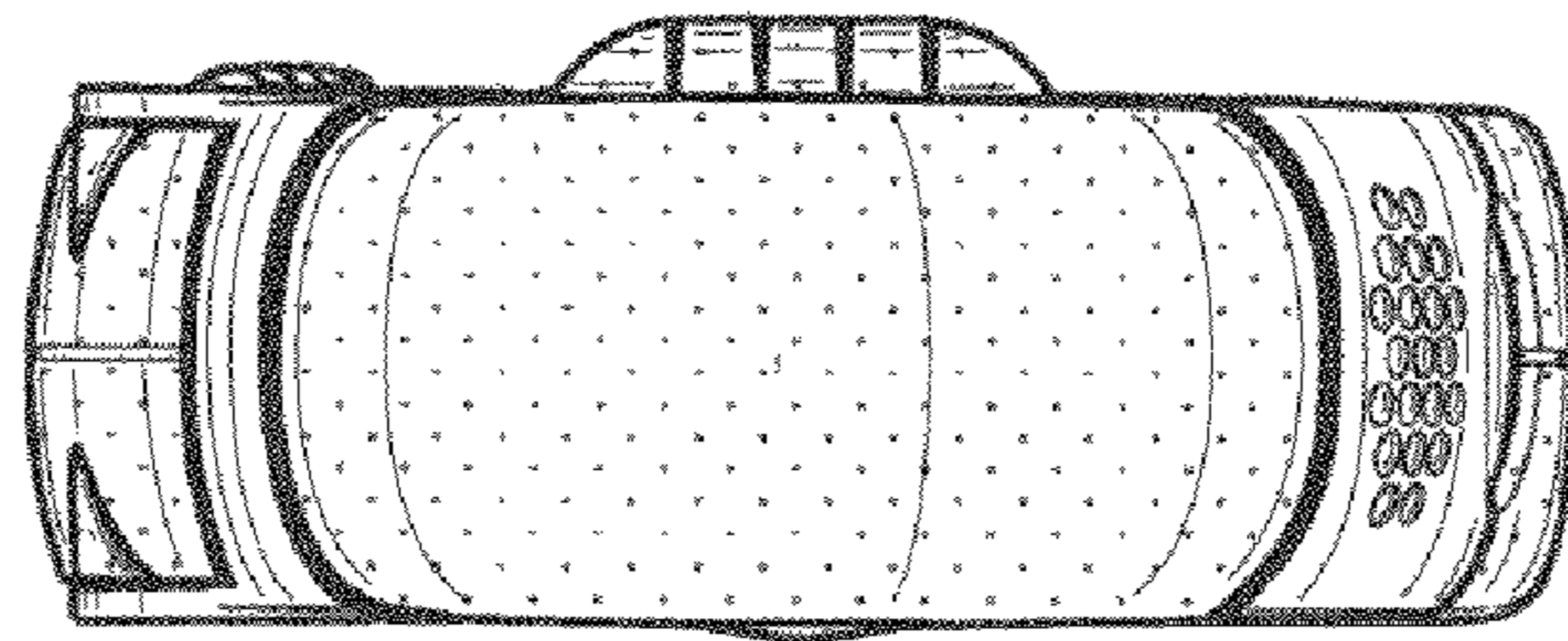

FIG. 5

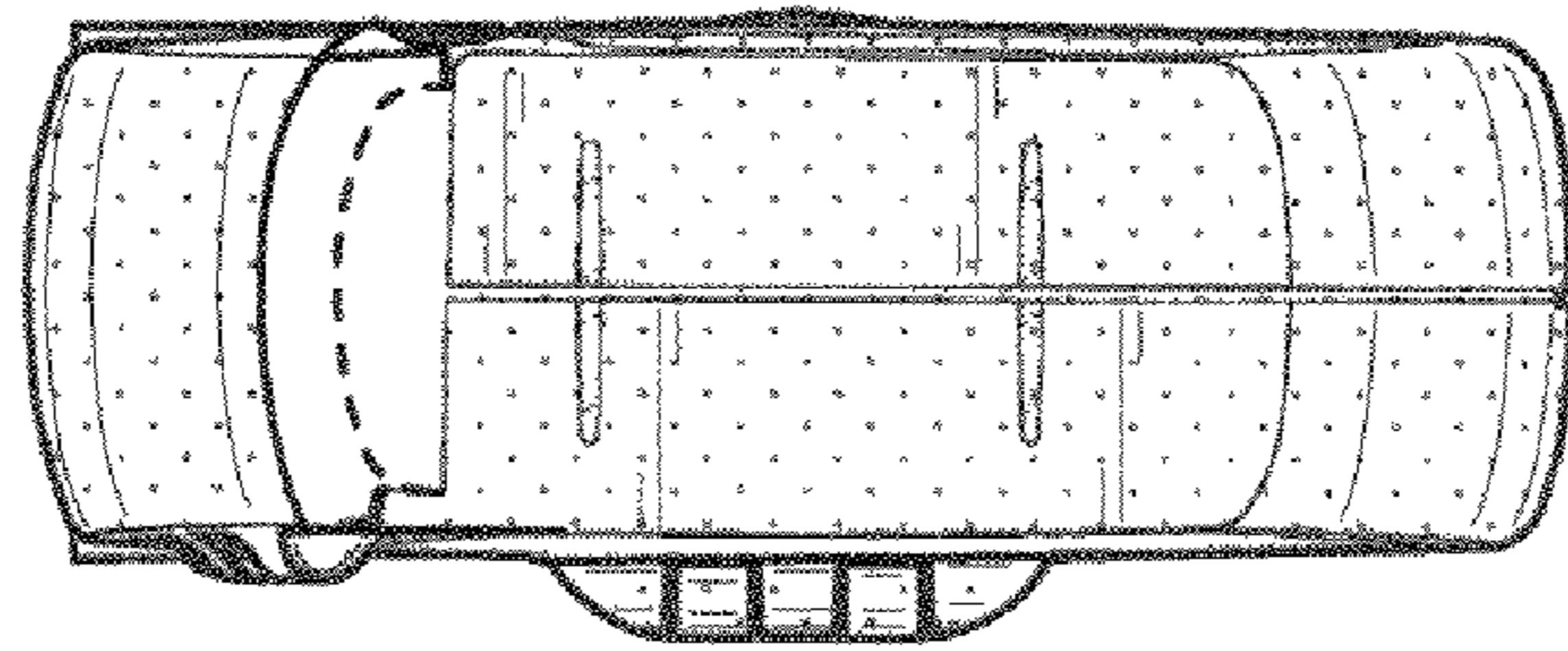

FIG. 6



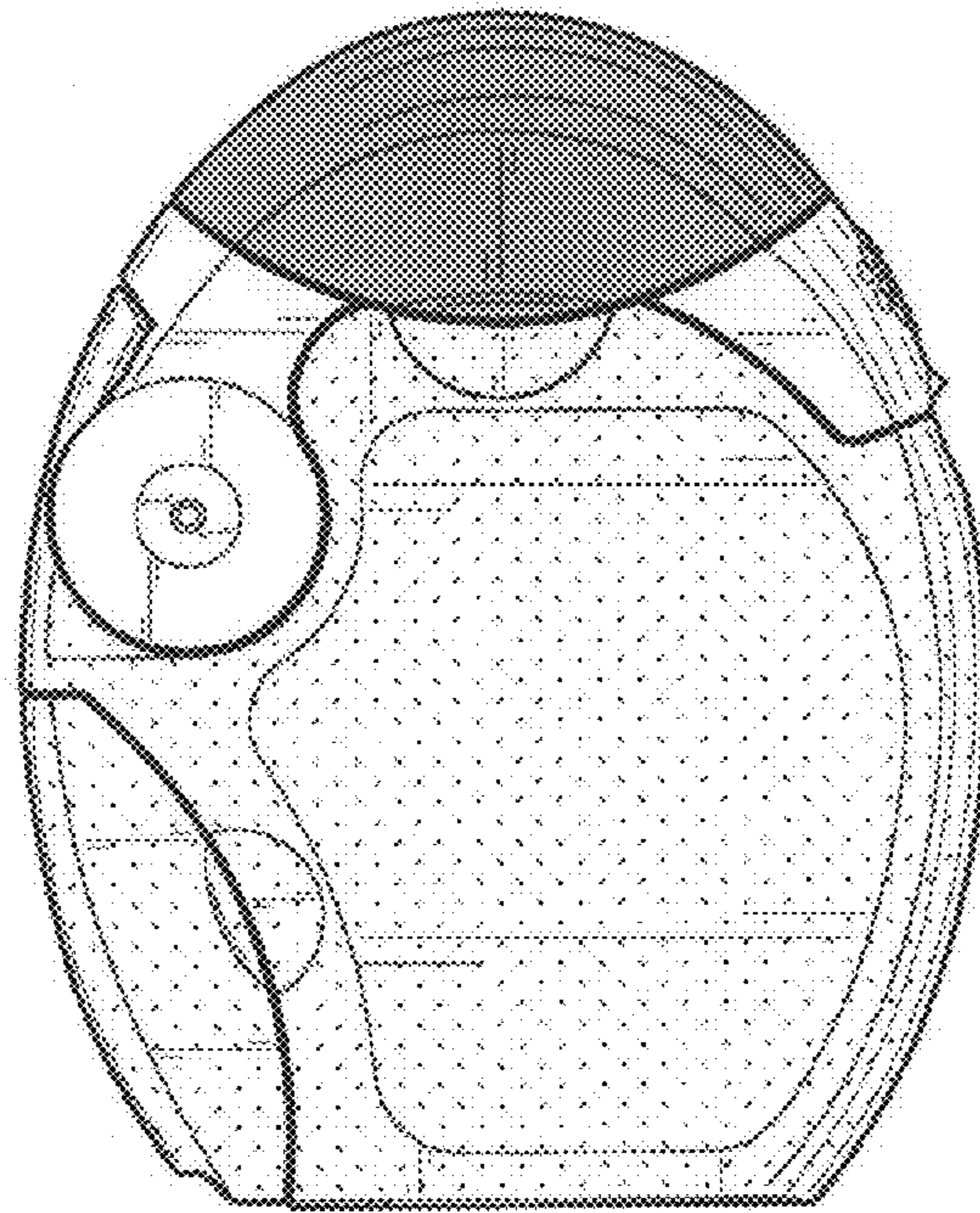

FIG. 7

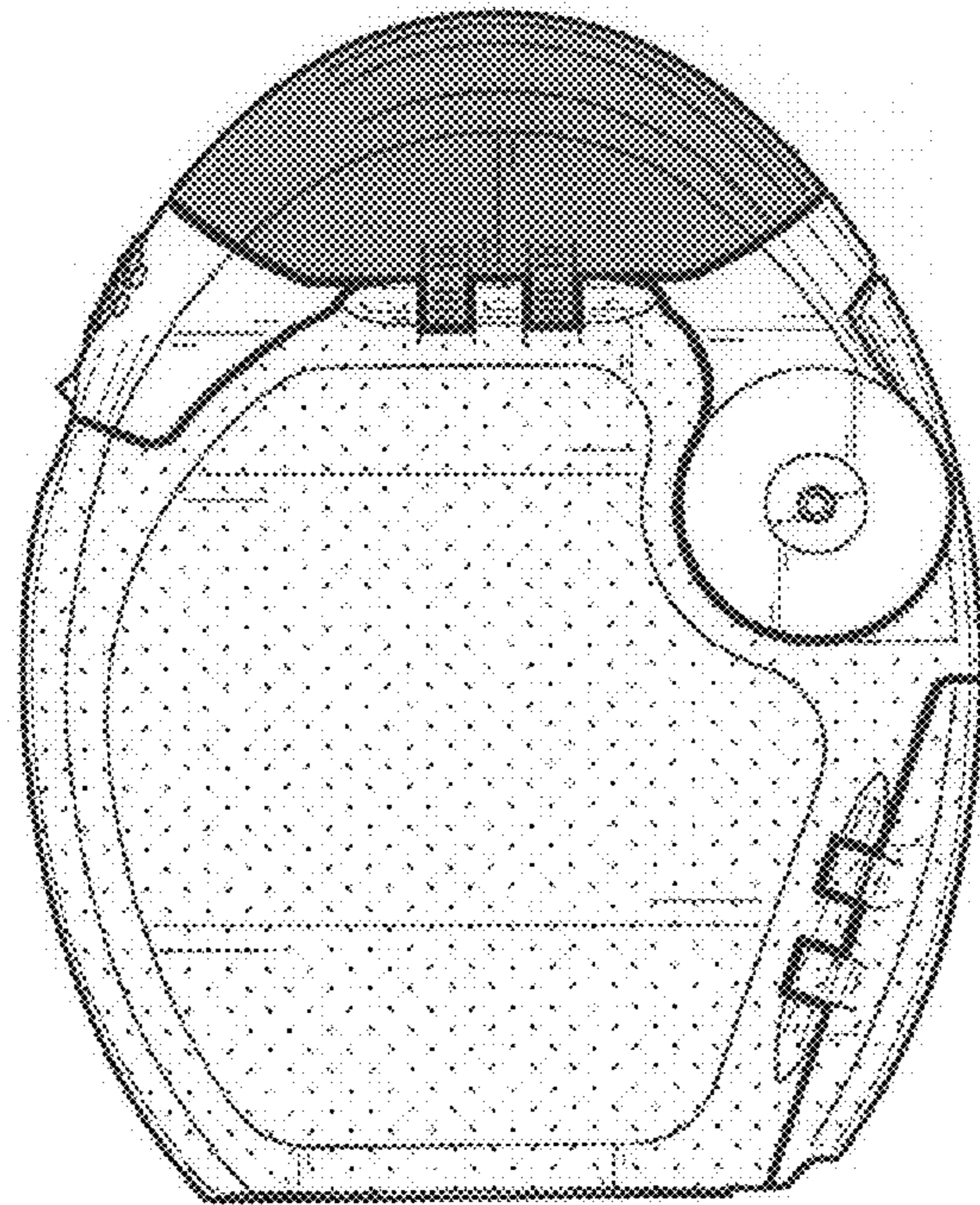

FIG. 8

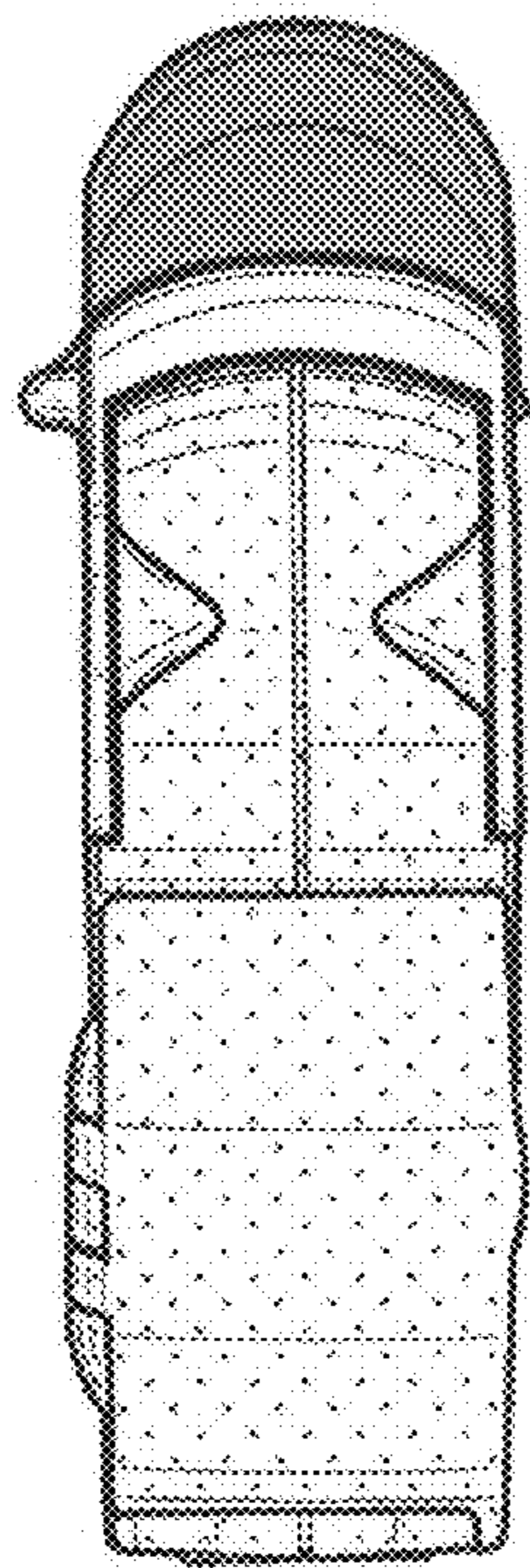

FIG. 9

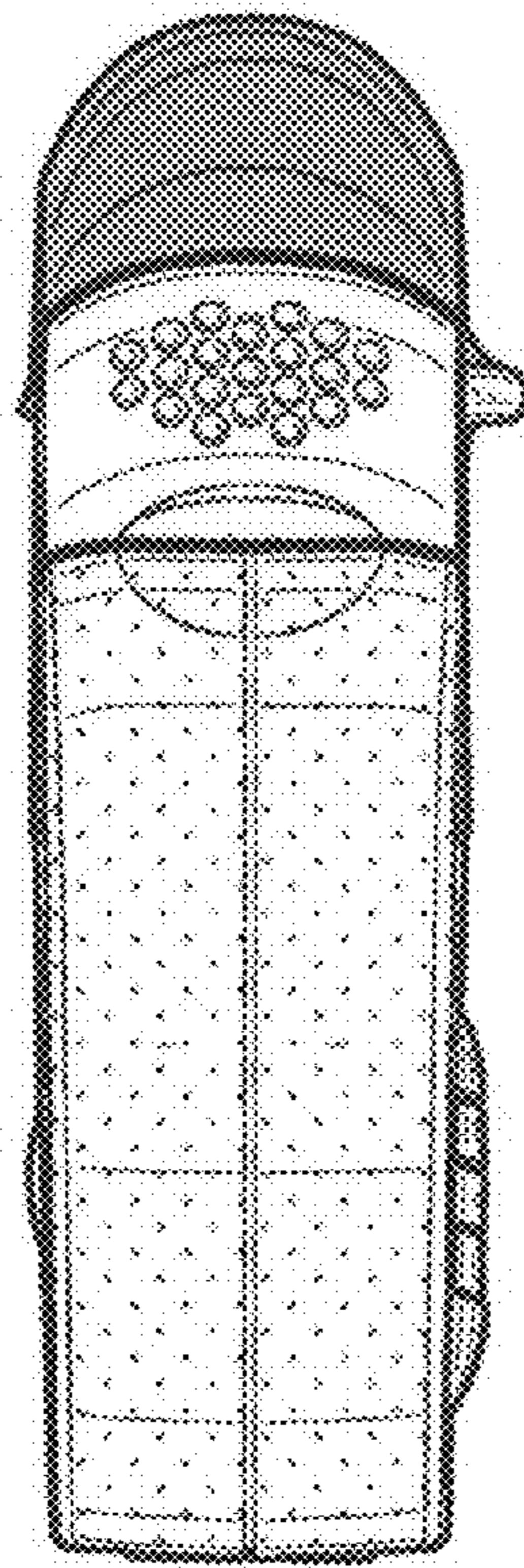

FIG. 10

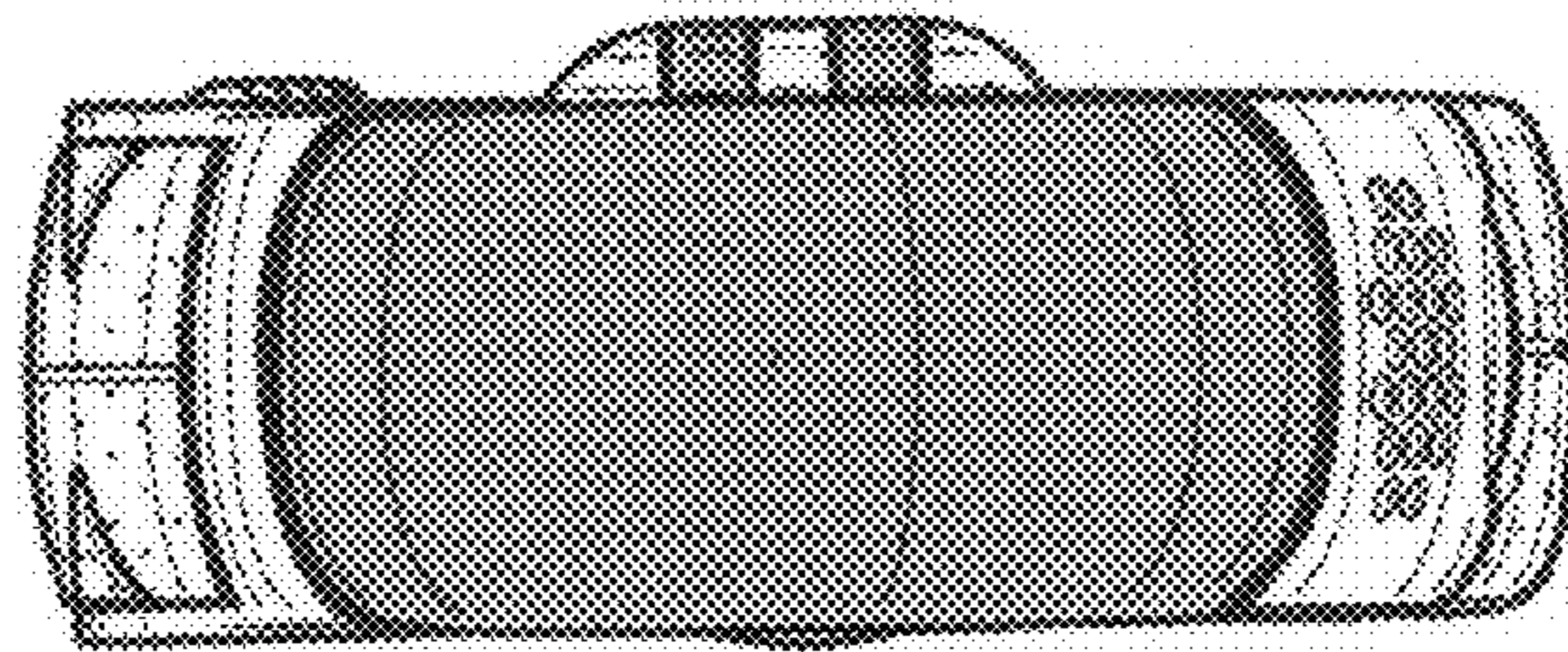

FIG. 11

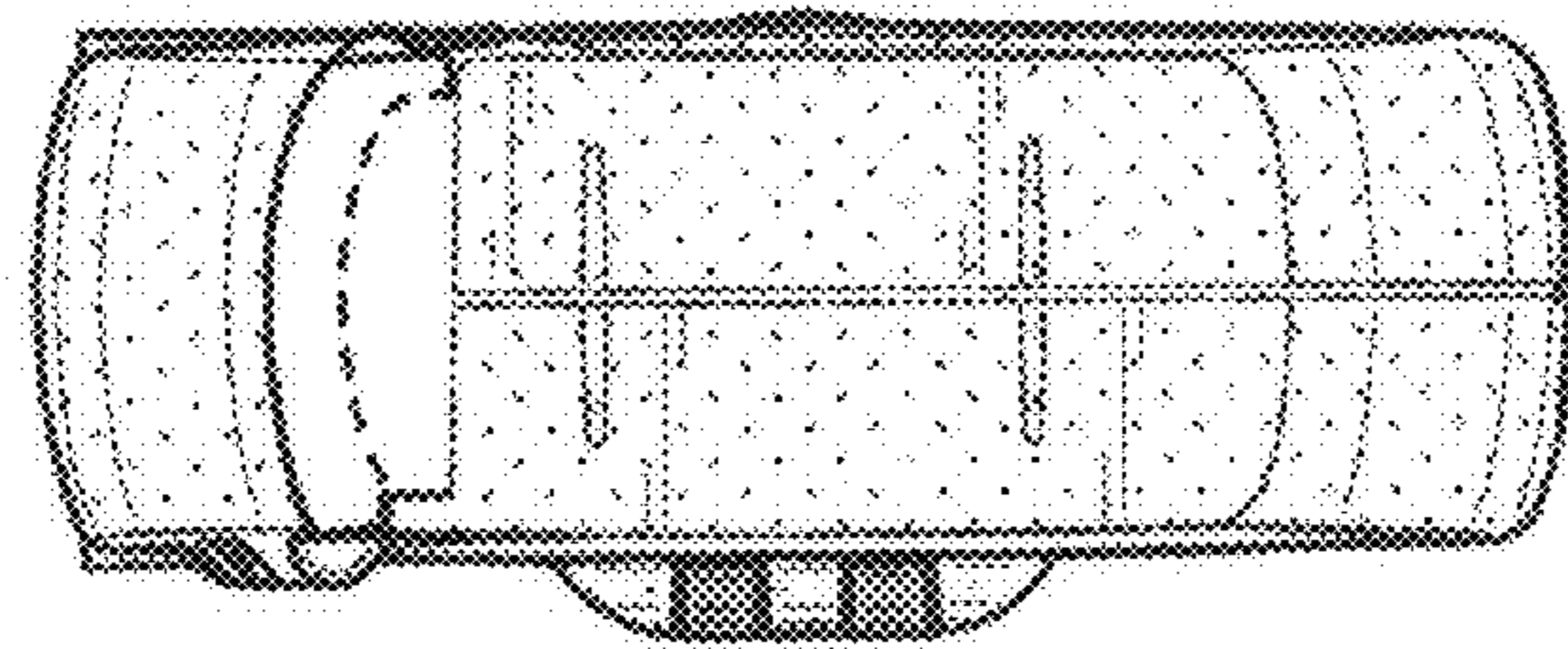

FIG. 12