



US00D623046S

(12) **United States Design Patent**
Murphy

(10) **Patent No.:** **US D623,046 S**

(45) **Date of Patent:** **** Sep. 7, 2010**

(54) **HANGER WITH DECORATIVE FLANGE**

(75) Inventor: **Gordon Murphy**, 622 Modrow Rd.,
Kalama, WA (US) 98625

(73) Assignee: **Gordon Murphy**, Kalama, WA (US)

(**) Term: **14 Years**

(21) Appl. No.: **29/347,411**

(22) Filed: **Dec. 23, 2009**

(51) **LOC (9) Cl.** **08-05**

(52) **U.S. Cl.** **D8/367; D8/373**

(58) **Field of Classification Search** **D8/367,**
D8/373, 370; 248/301, 304

See application file for complete search history.

(56) **References Cited**

U.S. PATENT DOCUMENTS

1,247,912 A	11/1917	Wardner
1,292,956 A	1/1919	McConnal
D170,196 S	8/1953	Gries
3,224,721 A	12/1965	Malmquist
5,549,234 A	8/1996	Hong

D410,378 S *	6/1999	Aganian	D8/367
6,443,409 B1	9/2002	Zanzucchi		
D582,760 S *	12/2008	Barrese	D8/367
D587,917 S *	3/2009	Barrese	D6/367

* cited by examiner

Primary Examiner—Holly H Baynham

(74) *Attorney, Agent, or Firm*—Robert J. Ireland

(57) **CLAIM**

The ornamental design for a hanger with decorative flange, as shown and described.

DESCRIPTION

FIG. 1 is a perspective view of a hanger with decorative flange showing my new design;

FIG. 2 is a front elevational view thereof;

FIG. 3 is a rear elevational view thereof;

FIG. 4 is a right side elevational view with the left side being a mirror image thereof;

FIG. 5 is a top view thereof; and,

FIG. 6 is a bottom view thereof.

1 Claim, 5 Drawing Sheets

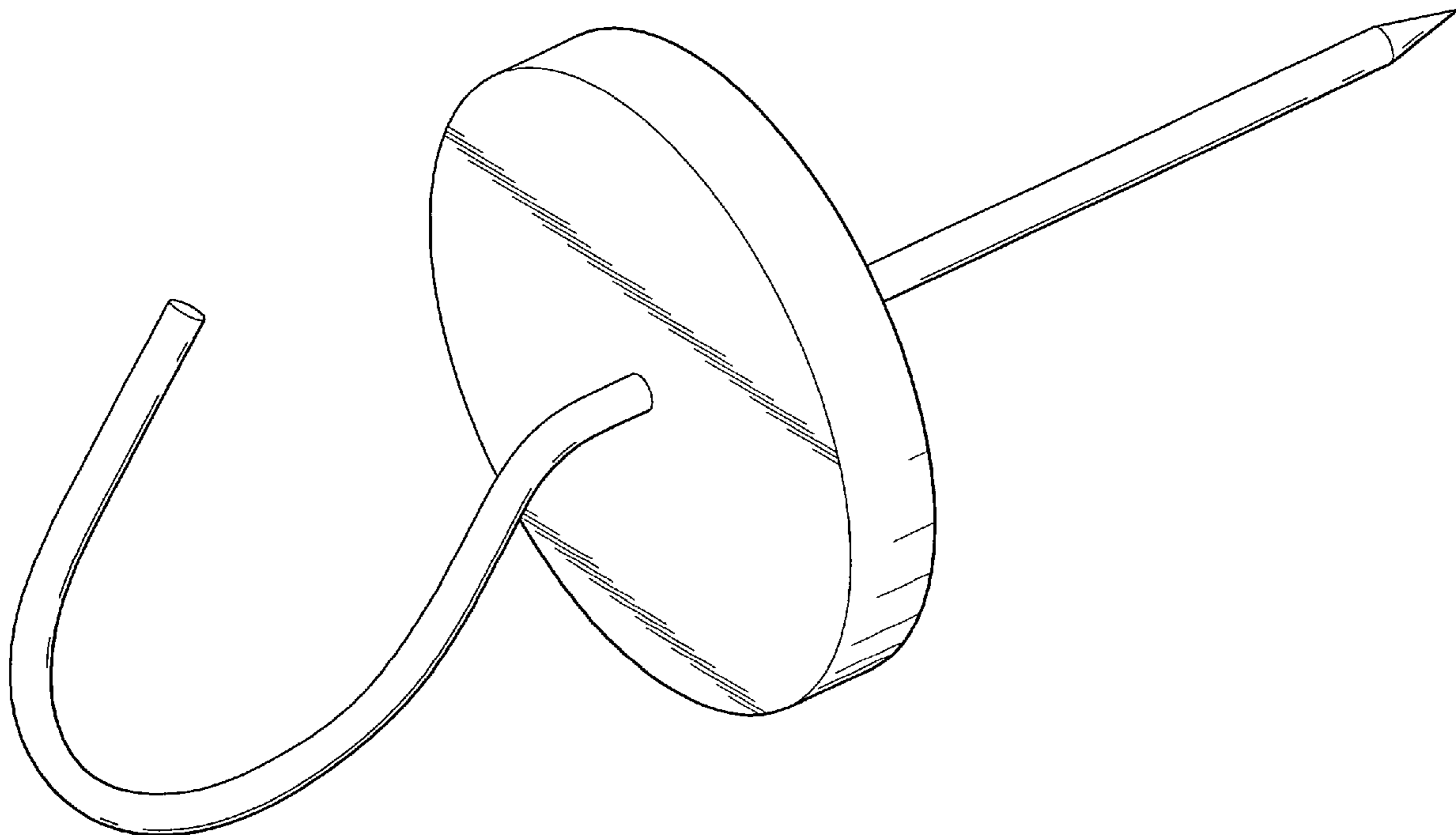

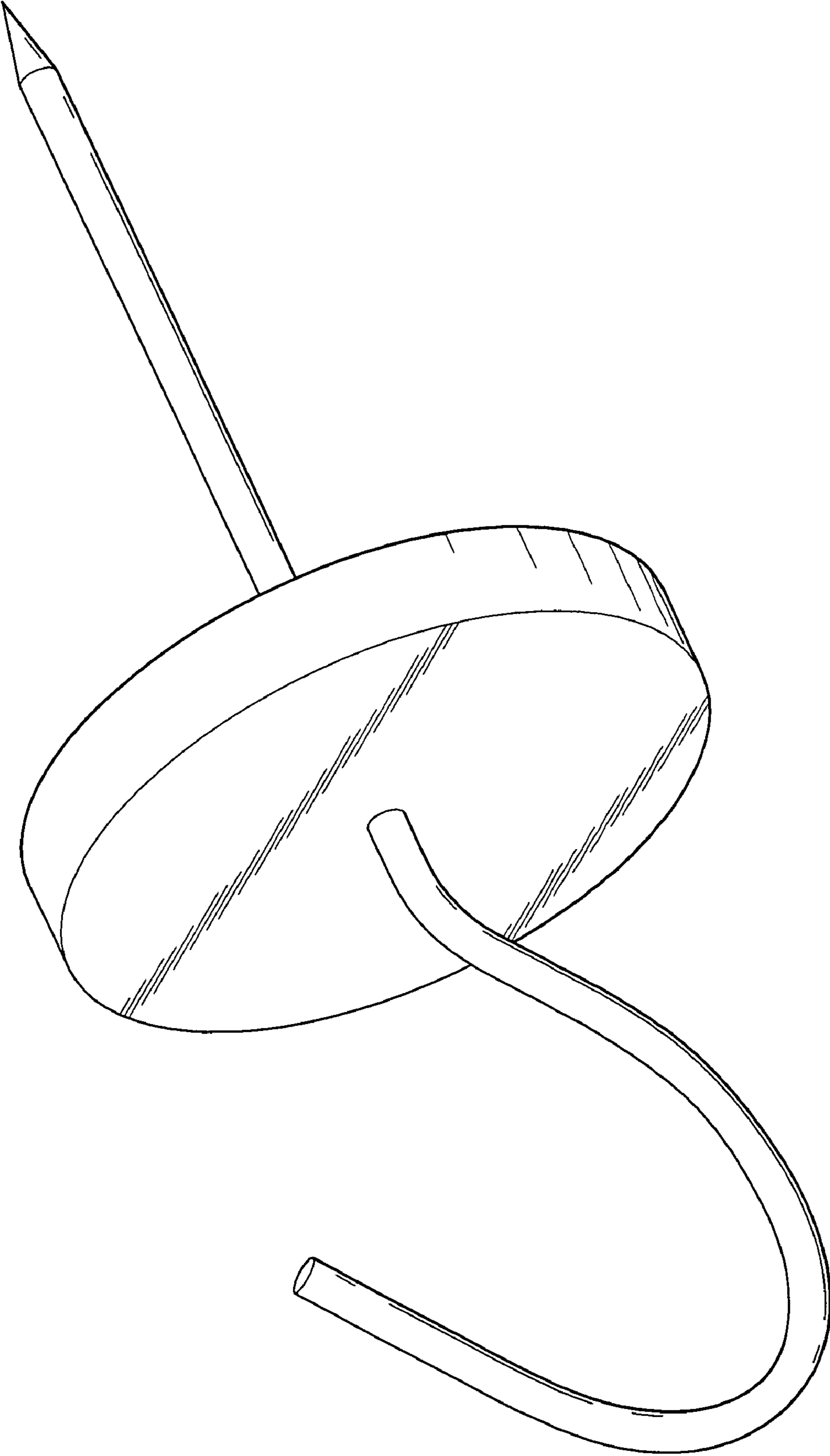

FIG. 1

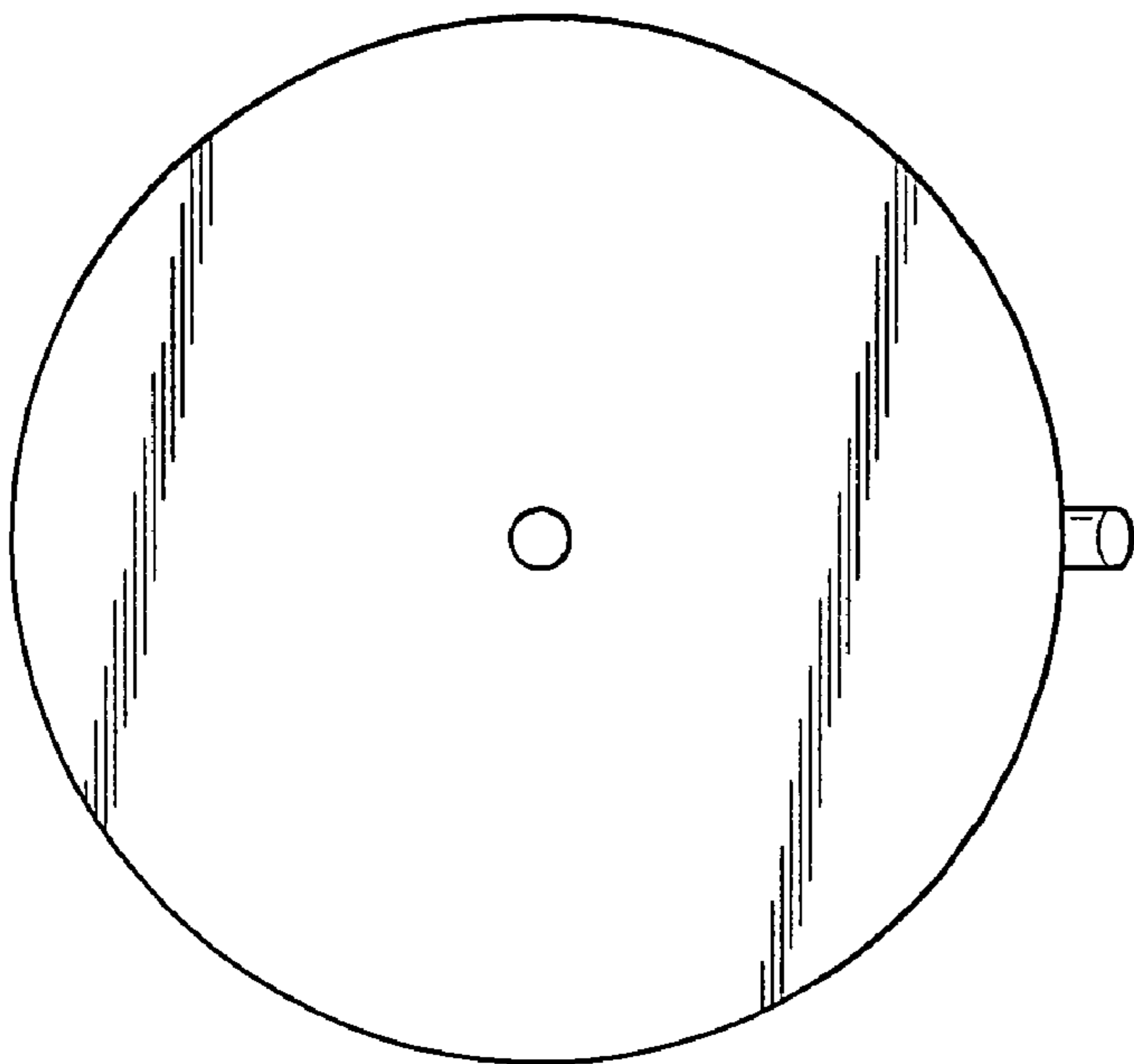

FIG. 2

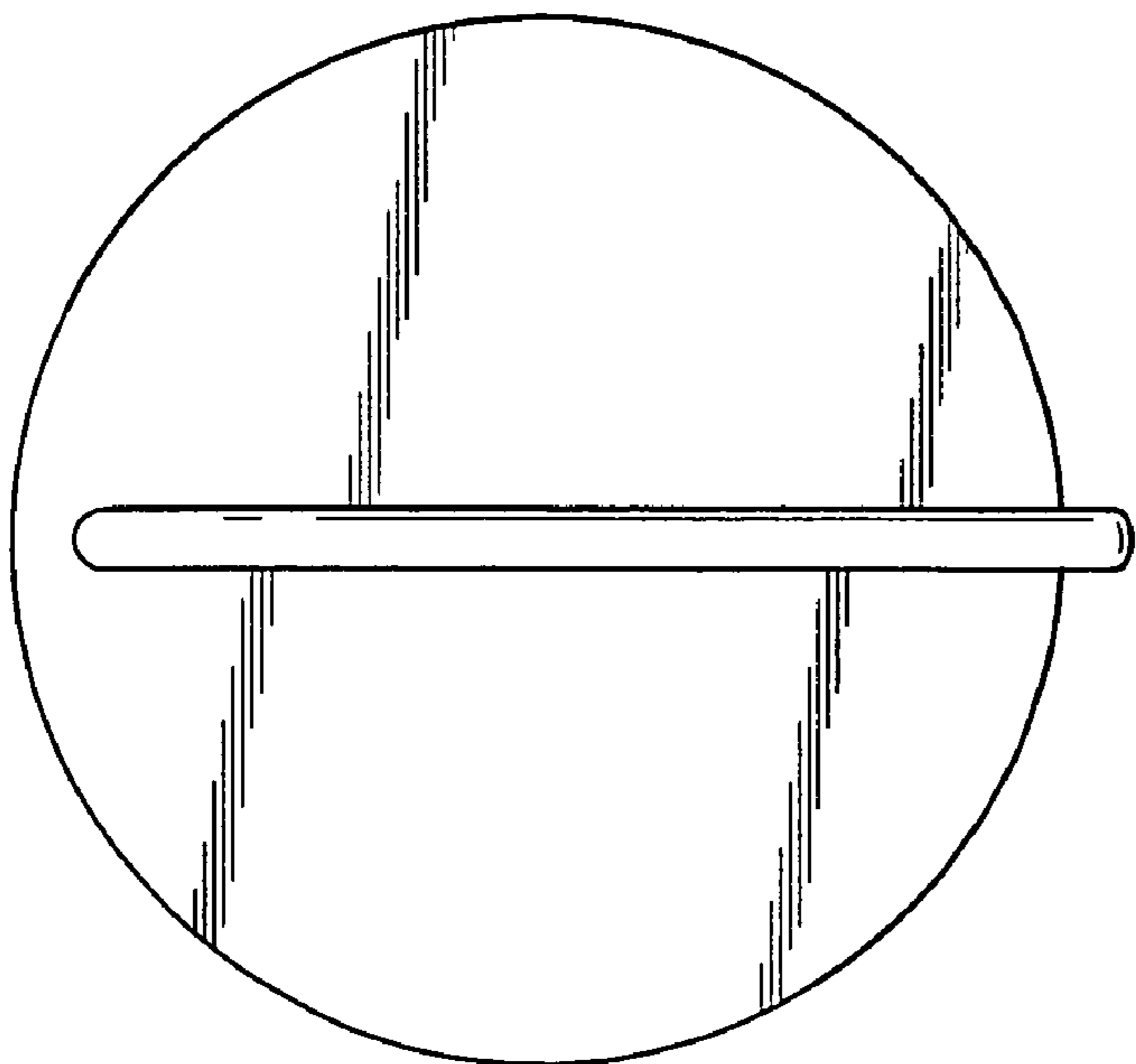

FIG. 3

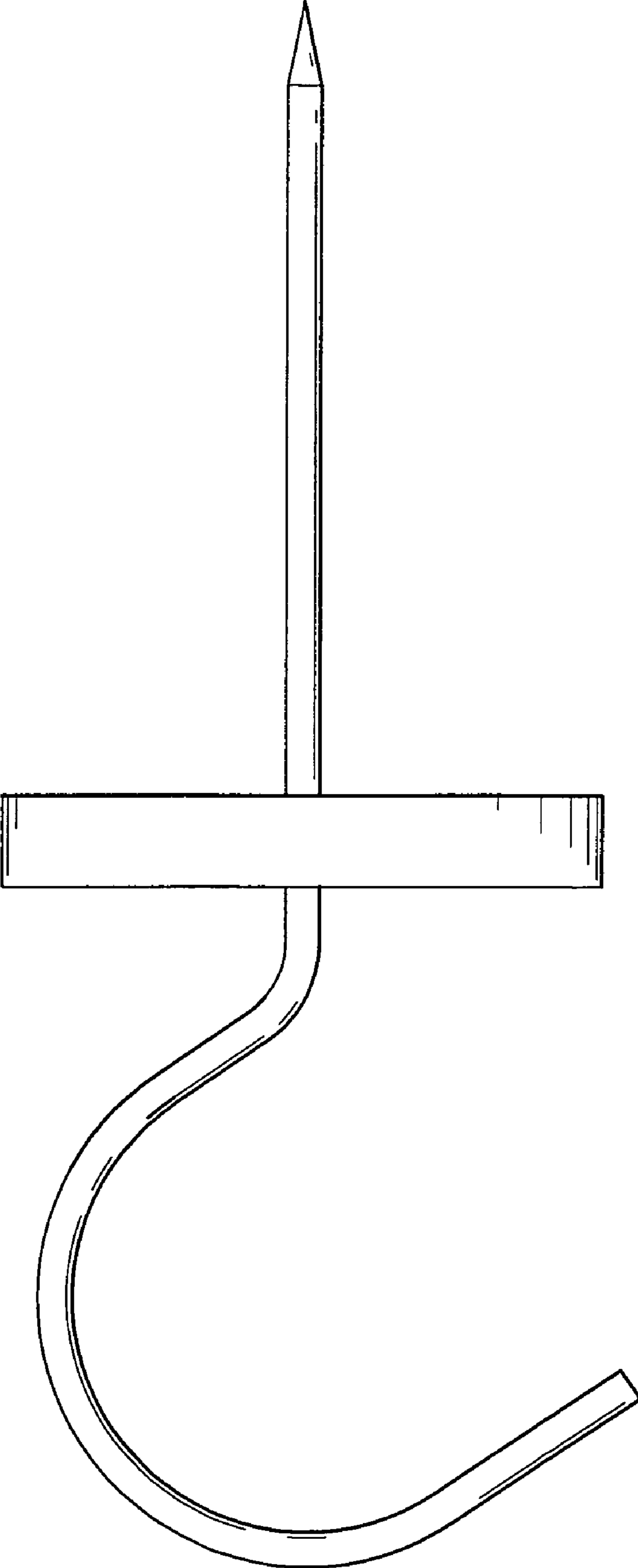

FIG. 4

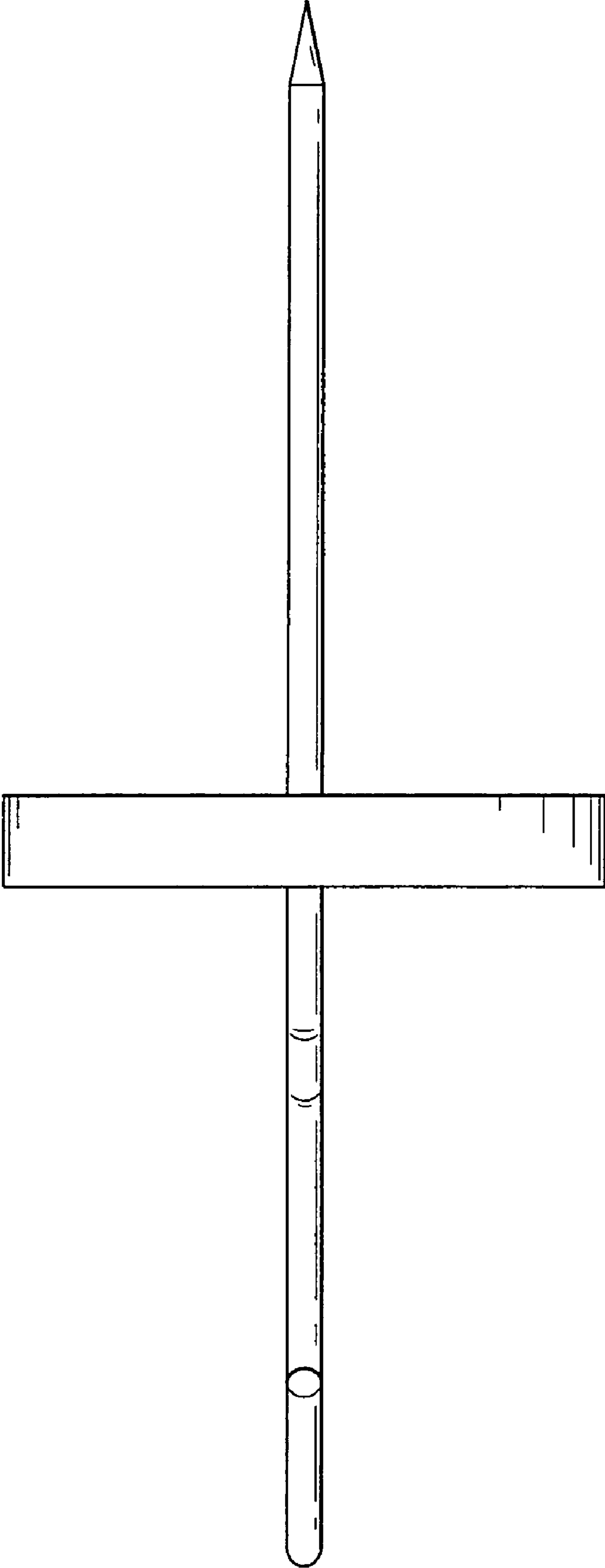

FIG. 5

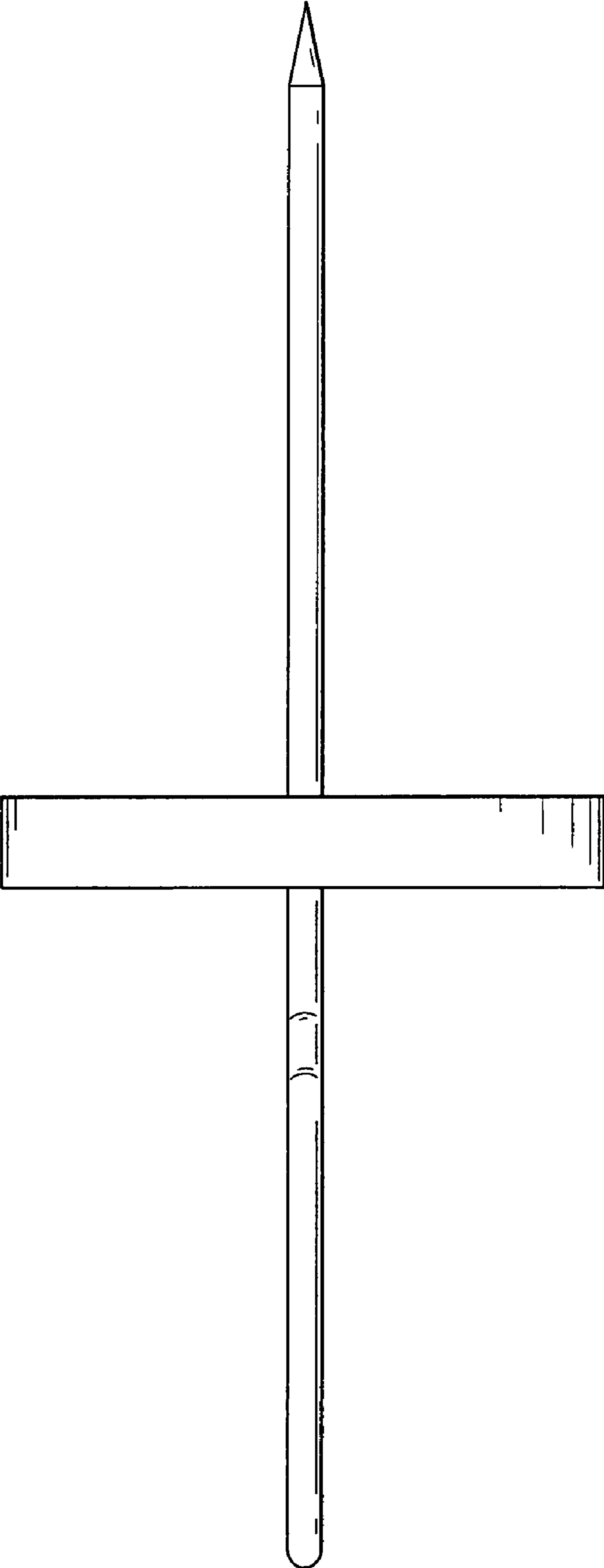

FIG. 6