



US00D622952S

(12) **United States Design Patent**  
**Tharp**

(10) **Patent No.:** **US D622,952 S**

(45) **Date of Patent:** **\*\* Sep. 7, 2010**

(54) **UMBRELLA**

*Primary Examiner*—Doris Clark

(76) **Inventor:** **Bruce Mitchell Tharp**, 1322 S. Wabash Ave., Suite 305, Chicago, IL (US) 60605

(57) **CLAIM**

The ornamental design for an umbrella, as shown and described.

(\*\*) **Term:** **14 Years**

(21) **Appl. No.:** **29/358,014**

**DESCRIPTION**

(22) **Filed:** **Mar. 21, 2010**

FIG. 1 is a front elevation view of my new design for an umbrella in a closed position;

(51) **LOC (9) Cl.** ..... **03-03**

FIG. 2 is a right-side elevation view thereof in a closed position;

(52) **U.S. Cl.** ..... **D3/5**

(58) **Field of Classification Search** ..... D3/5,  
D3/10, 12, 13, 16, 17; 135/15.1, 23, 20.1,  
135/20.3, 25.31, 33.7, 39, 40, 25.01, 21,  
135/16, 44

FIG. 3 is a front elevation view thereof in an open position;

FIG. 4 is a right-side elevation view thereof in an open position;

See application file for complete search history.

FIG. 5 is an enlarged back elevation view of the umbrella's handle;

(56) **References Cited**

**U.S. PATENT DOCUMENTS**

D341,247 S *	11/1993	Hampton	.....	D3/5
6,079,430 A *	6/2000	Yamamoto	.....	135/16
6,330,887 B1 *	12/2001	Chen	.....	135/16
D461,305 S *	8/2002	Clarke et al.	.....	D3/5
D464,481 S *	10/2002	Webster	.....	D3/5
D496,782 S *	10/2004	Miles	.....	D3/5
D521,229 S *	5/2006	Mariano	.....	D3/5

FIG. 6 is an enlarged left-side elevation view of the umbrella's handle;

FIG. 7 is a top plan view thereof taken from line 5—5 of FIG. 5; and,

FIG. 8 is a bottom plan view thereof.

The broken lines in the drawings are included for the purpose of illustrating environmental subject matter and form no part of the claimed design.

\* cited by examiner

**1 Claim, 6 Drawing Sheets**

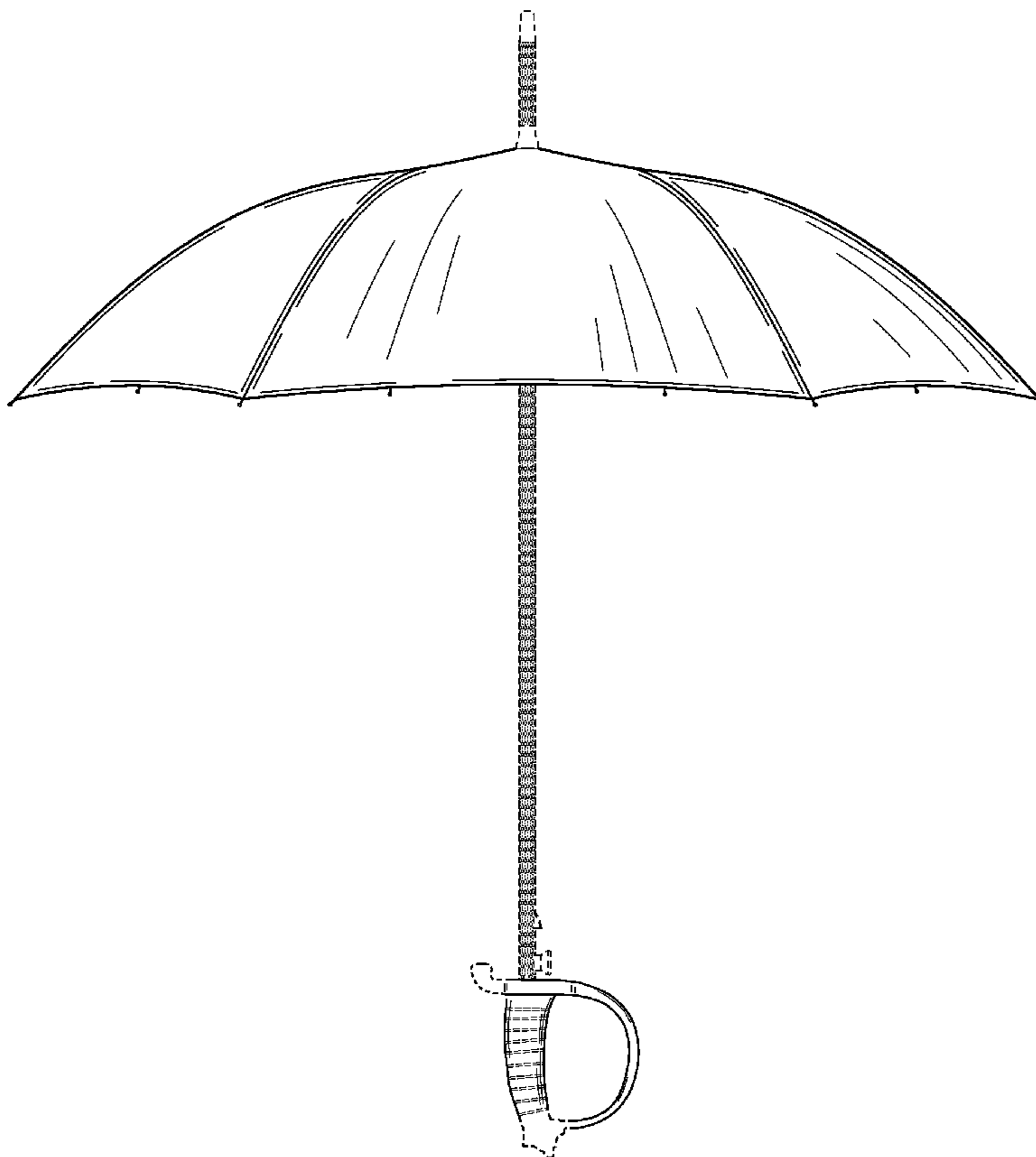

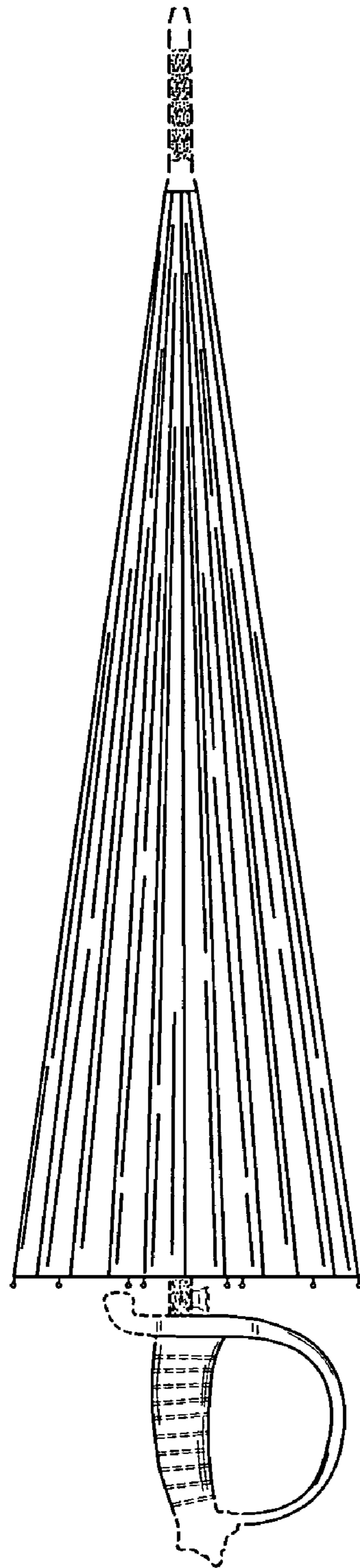

FIG. 1

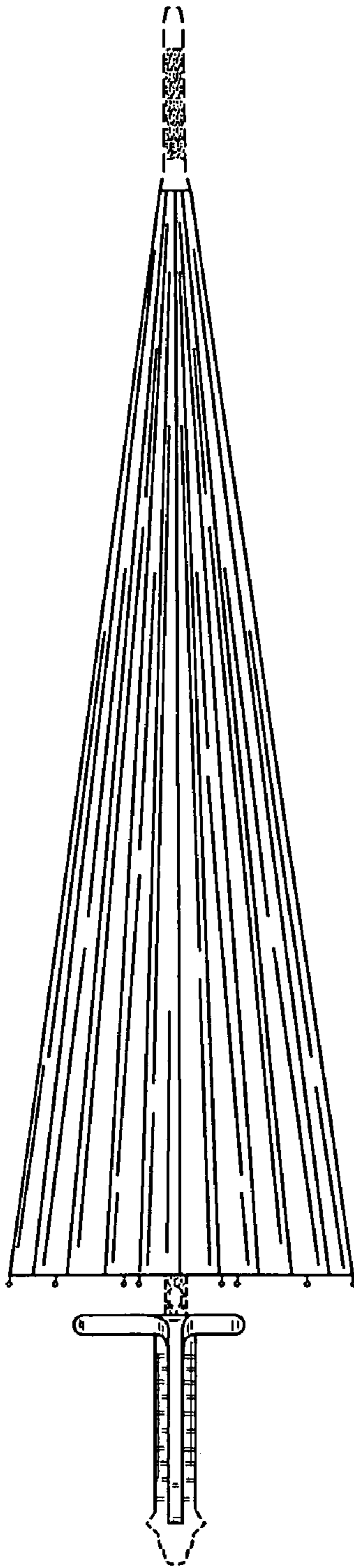

FIG. 2

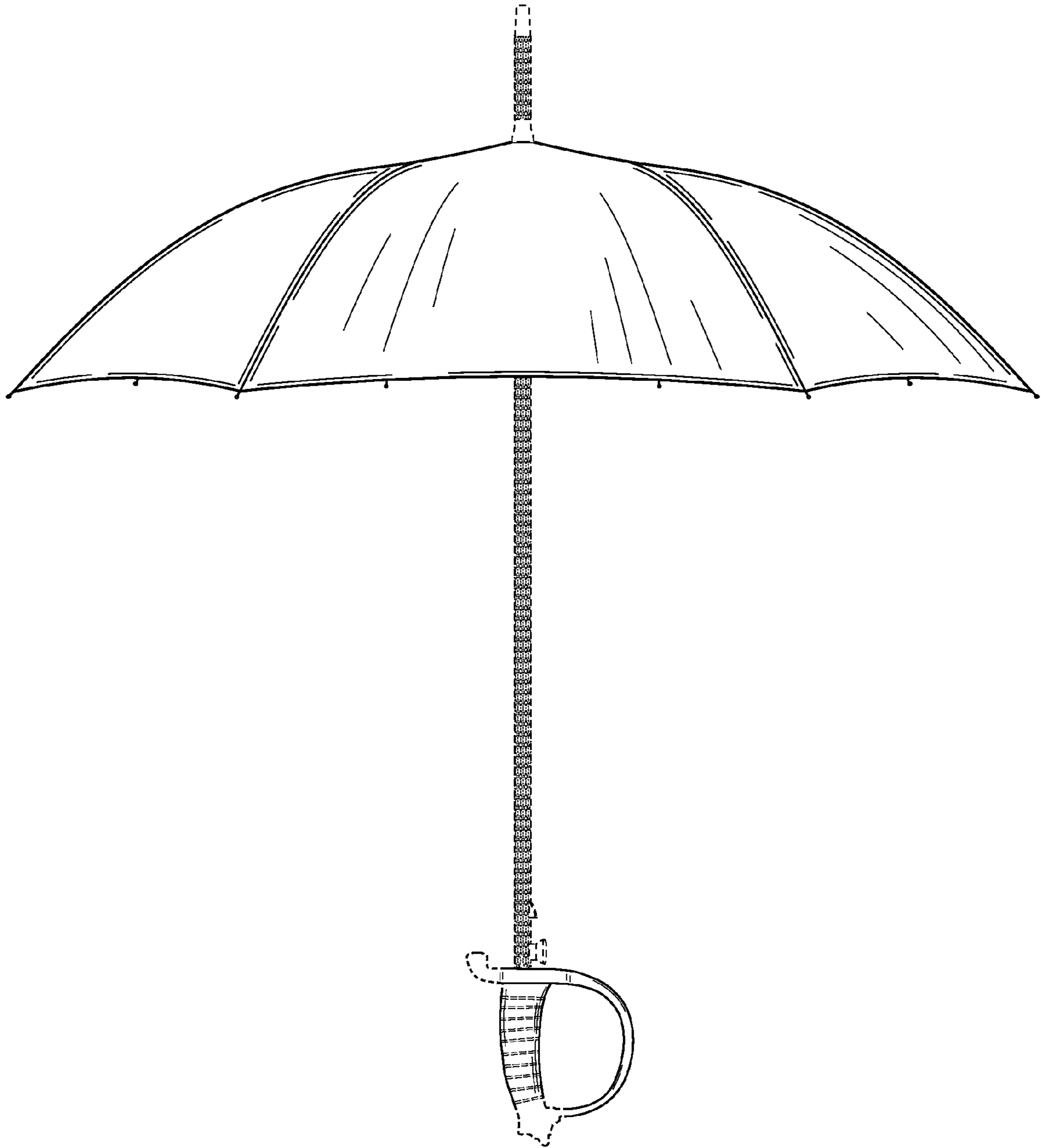

FIG. 3

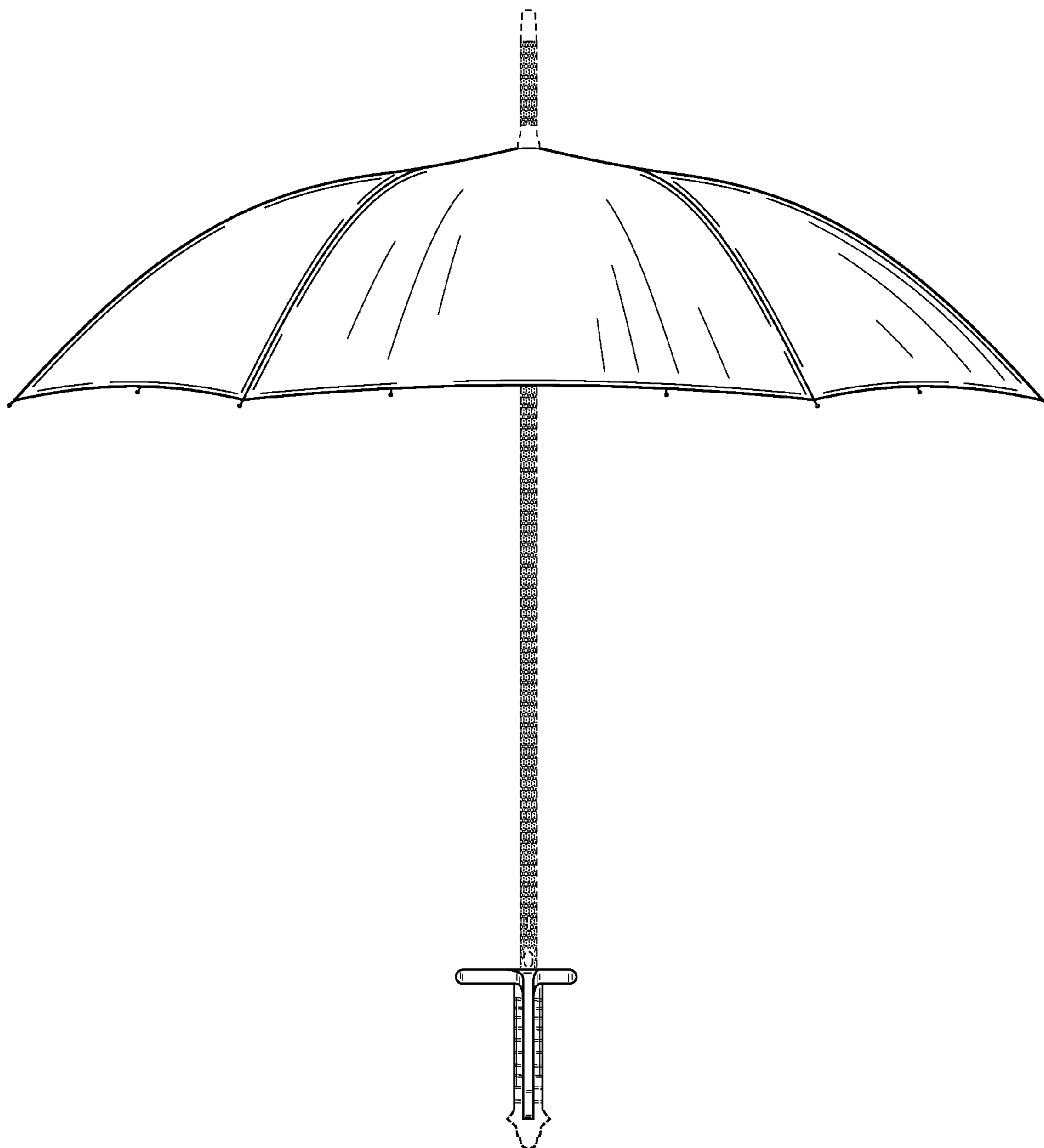

FIG. 4

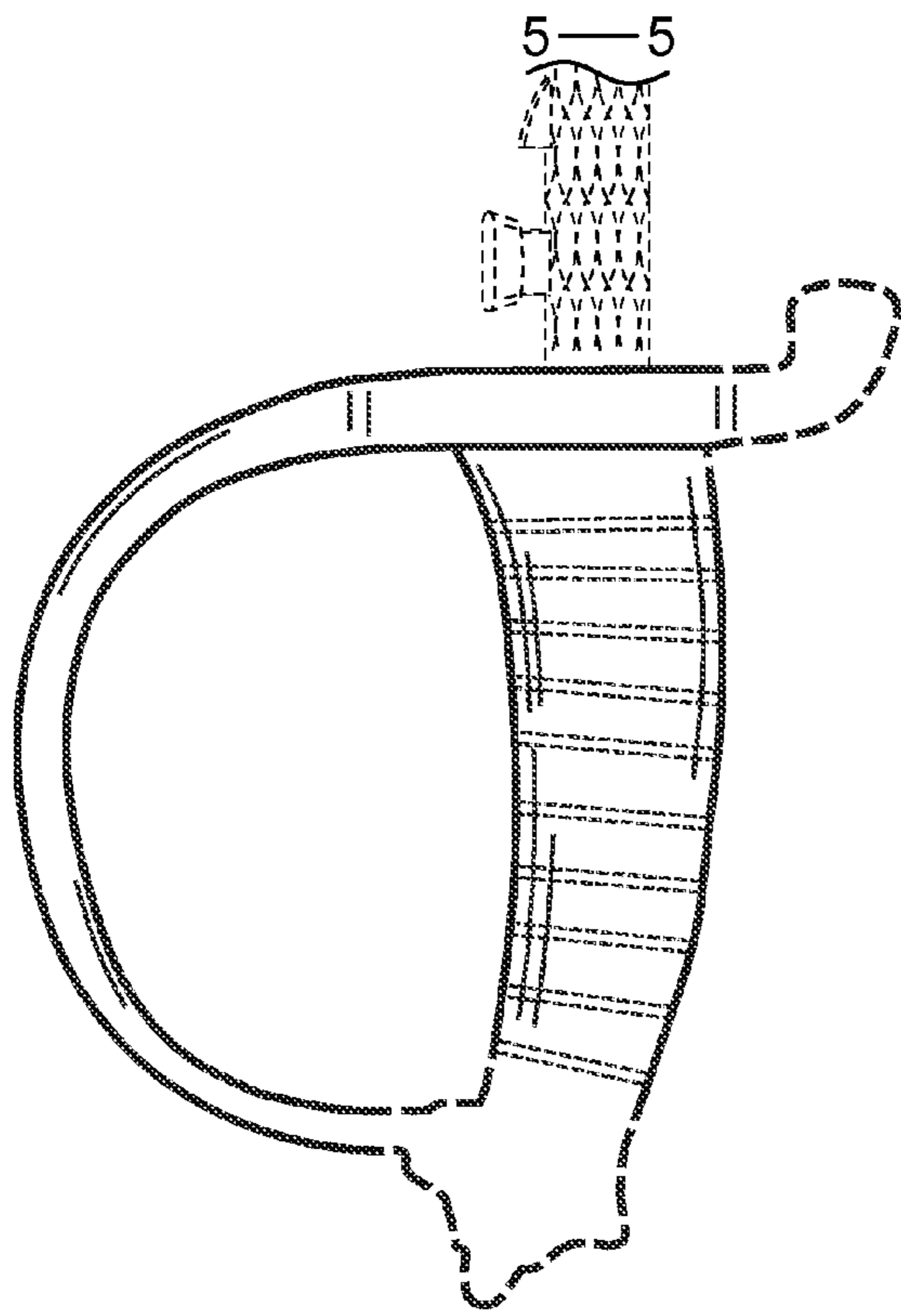

FIG. 5

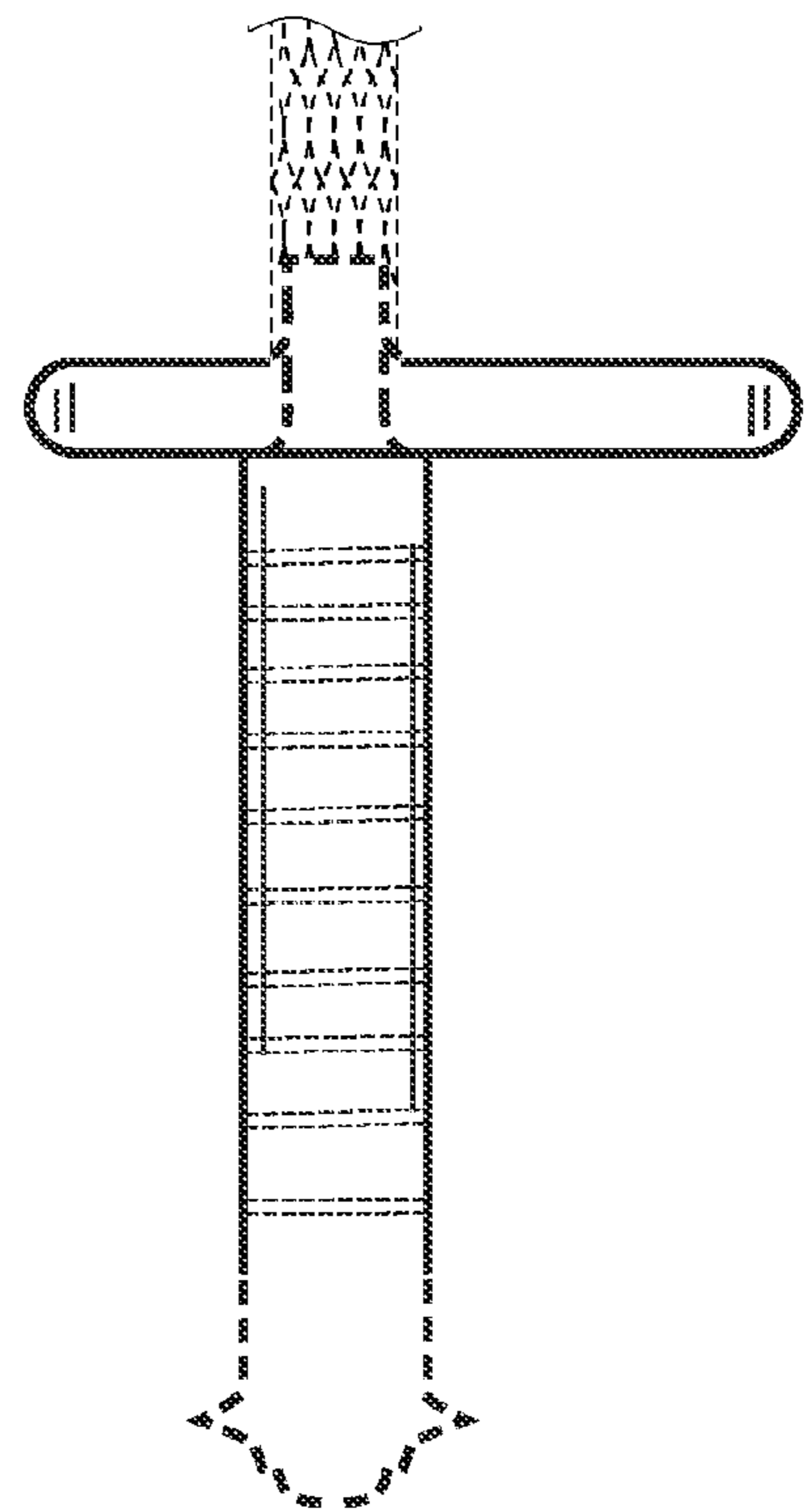

FIG. 6

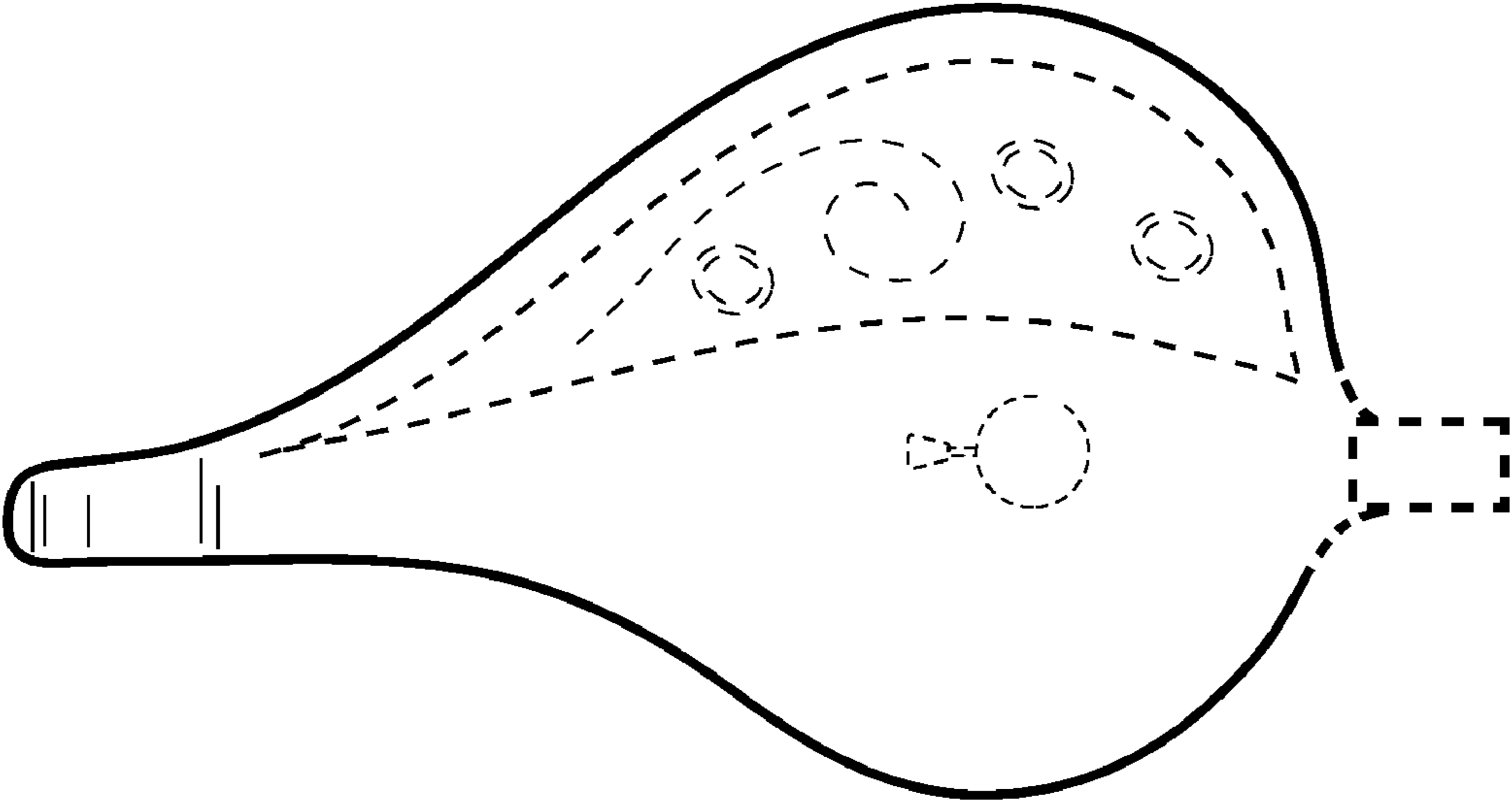

FIG. 7

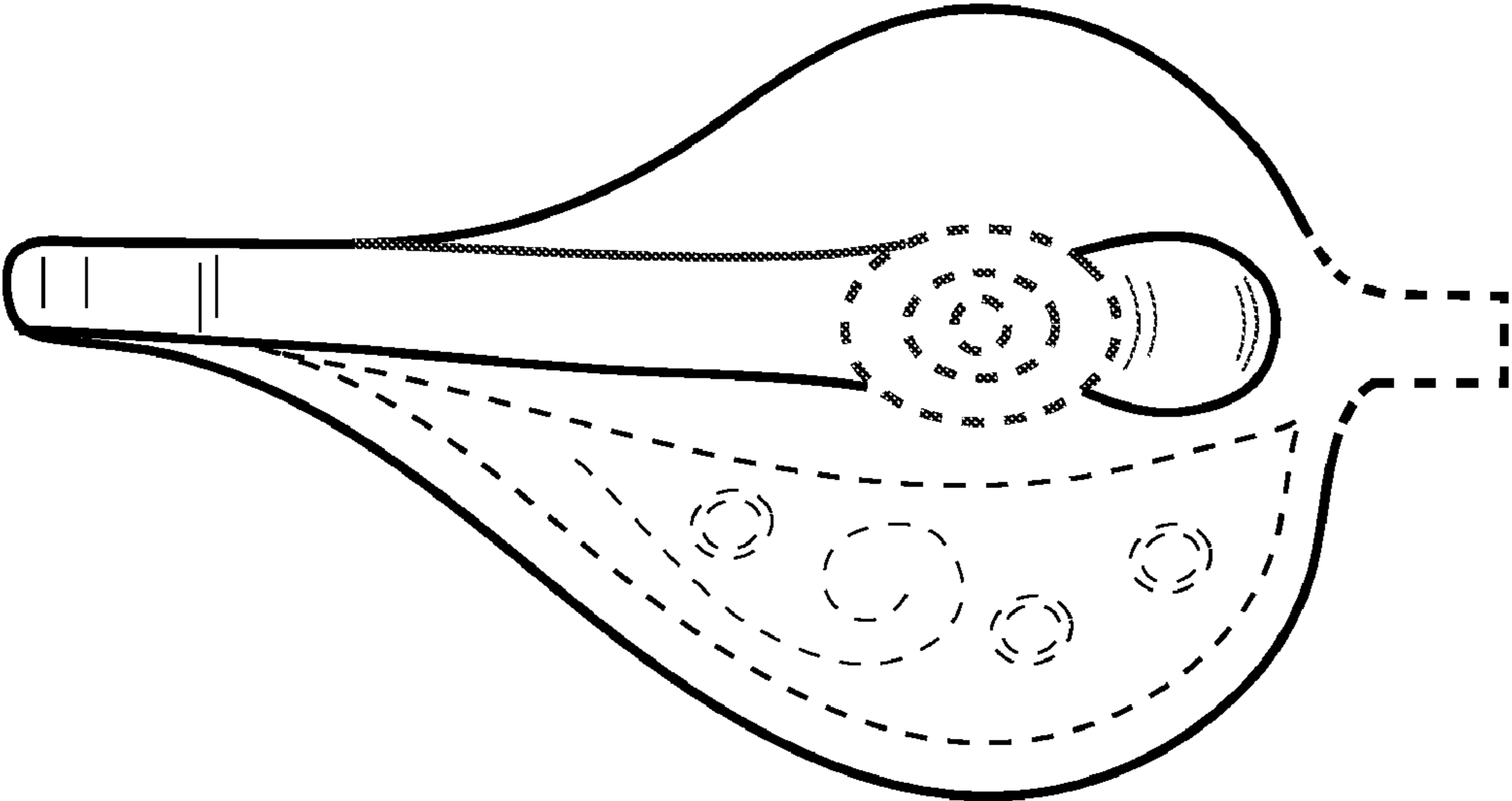

FIG. 8