



US00D622948S

(12) **United States Design Patent**
Earle

(10) **Patent No.:** **US D622,948 S**

(45) **Date of Patent:** **** Sep. 7, 2010**

(54) **PORTION OF A FOOTBED**

(75) Inventor: **John Earle**, Lake Oswego, OR (US)

(73) Assignee: **Deckers Outdoor Corporation**, Goleta, CA (US)

(**) Term: **14 Years**

(21) Appl. No.: **29/293,486**

(22) Filed: **Nov. 28, 2007**

(51) **LOC (9) Cl.** **02-04**

(52) **U.S. Cl.** **D2/961**

(58) **Field of Classification Search** D2/896,
D2/916, 917, 918, 919, 922, 925, 926, 927,
D2/928, 929, 930, 931, 932, 935, 936, 946,
D2/961, 962, 976, 947, 949, 950, 951; 36/3 B,
36/7.5, 7.6, 7.7, 11.5, 25 R, 28, 29, 32 R,
36/43, 44, 59 B, 59 R, 136

See application file for complete search history.

(56) **References Cited**

U.S. PATENT DOCUMENTS

1,708,802	A *	4/1929	Sax	36/25 R
2,016,070	A *	10/1935	Brockman	36/25 R
2,090,935	A *	8/1937	Calderazzo	36/169
D132,621	S *	6/1942	Ivan	D2/949
2,402,227	A *	6/1946	Ihle	36/25 R
2,463,348	A *	3/1949	Atlas	36/11.5
2,509,335	A *	5/1950	Dadisman	36/11.5
2,979,835	A *	4/1961	Scholl	36/44
D310,598	S *	9/1990	Cummings	D2/947
5,390,430	A *	2/1995	Fitchmun et al.	36/30 R
D371,894	S *	7/1996	Gay et al.	D2/961
D396,341	S *	7/1998	Lozano et al.	D2/961
D416,602	S *	11/1999	Finn	D2/960
D416,668	S *	11/1999	Witjes	D2/947
D446,913	S *	8/2001	Holden	D2/916
D472,037	S *	3/2003	Masullo	D2/953
6,682,599	B2 *	1/2004	Gardner et al.	118/121

D496,526	S *	9/2004	Grisoni et al.	D2/961
D501,293	S *	2/2005	Bizzo	D2/949
D509,951	S *	9/2005	Johnson	D2/961
D531,790	S *	11/2006	Wurzburg	D2/961
D582,638	S *	12/2008	Ringholz	D2/947
2001/0003875	A1 *	6/2001	Moretti	36/3 B
2001/0016991	A1 *	8/2001	Sartor	36/3 B
2009/0205222	A1 *	8/2009	McLinden	36/92

OTHER PUBLICATIONS

UGG Winter 2002 Collection Catalog, Fluff Scuff model, photo of Fluff Scuff 2002.

* cited by examiner

Primary Examiner—Stella M Reid

Assistant Examiner—Elizabeth J Oswecki

(74) *Attorney, Agent, or Firm*—Greer, Burns & Crain, Ltd.

(57) **CLAIM**

The ornamental design for a portion of a footbed, as shown and described.

DESCRIPTION

FIG. 1 is a perspective view of a portion of a footbed in a used condition showing my new design;

FIG. 2 is a side elevational view thereof;

FIG. 3 is another side elevational view thereof;

FIG. 4 is a front elevational view thereof;

FIG. 5 is a rear elevational view thereof;

FIG. 6 is a top plan view thereof; and,

FIG. 7 is another top view of a portion of a footbed with the top portion of the shoe removed.

The broken line showing of portions of a shoe in FIGS. 1–7 is included for the purpose of illustrating only and forms no part of the claimed design. The broken lines which defines the bounds of the claimed design form no part thereof.

1 Claim, 6 Drawing Sheets

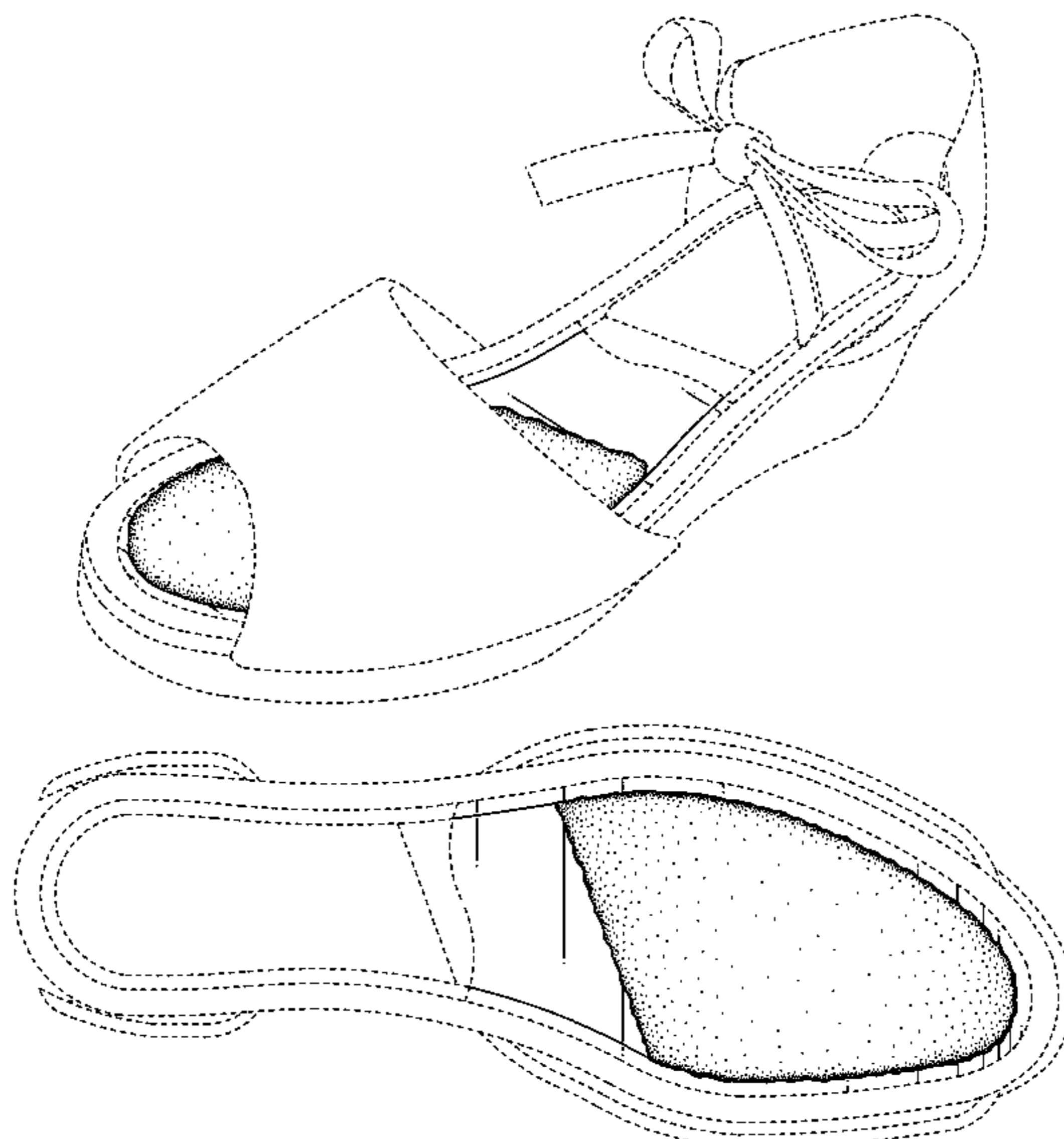

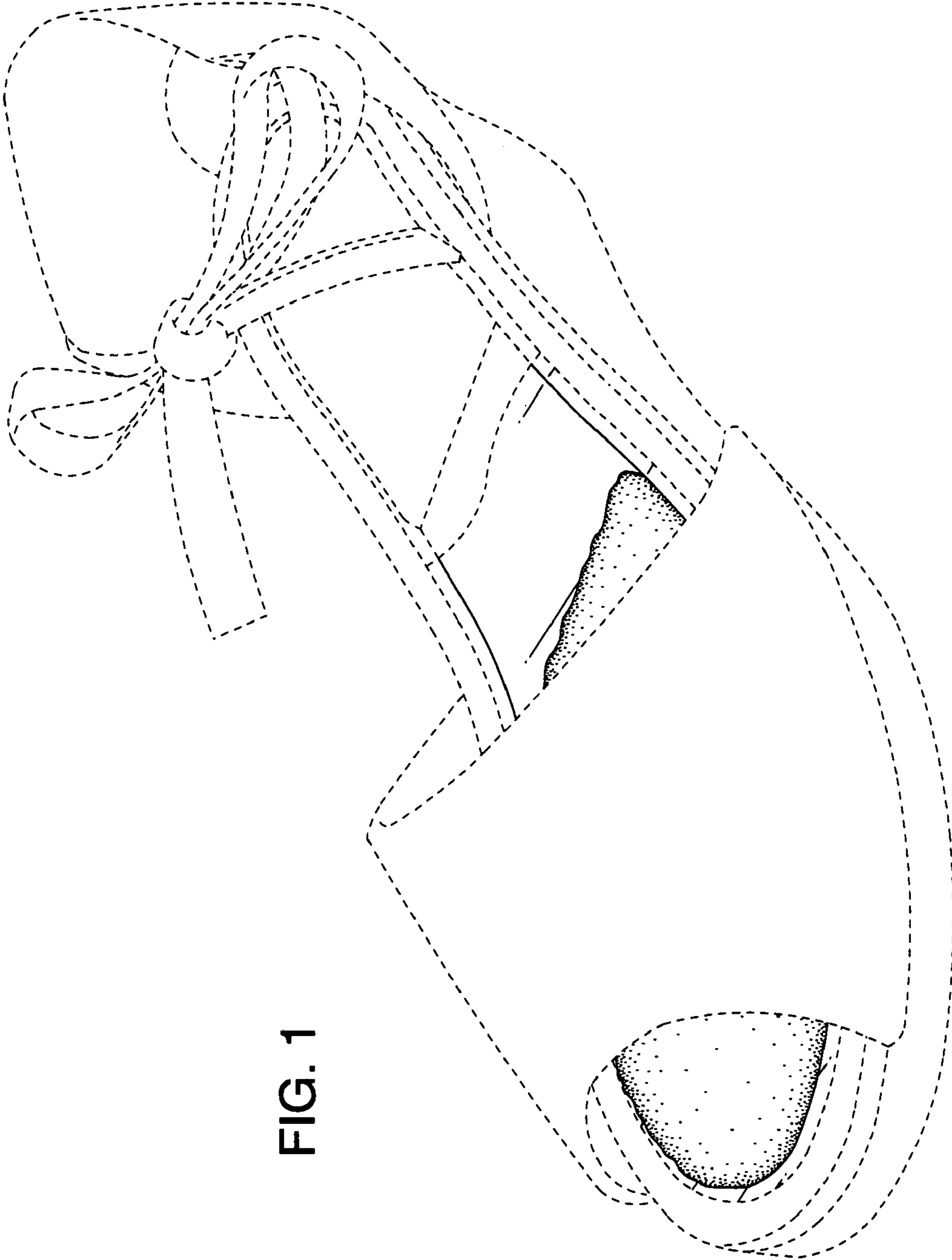

FIG. 1

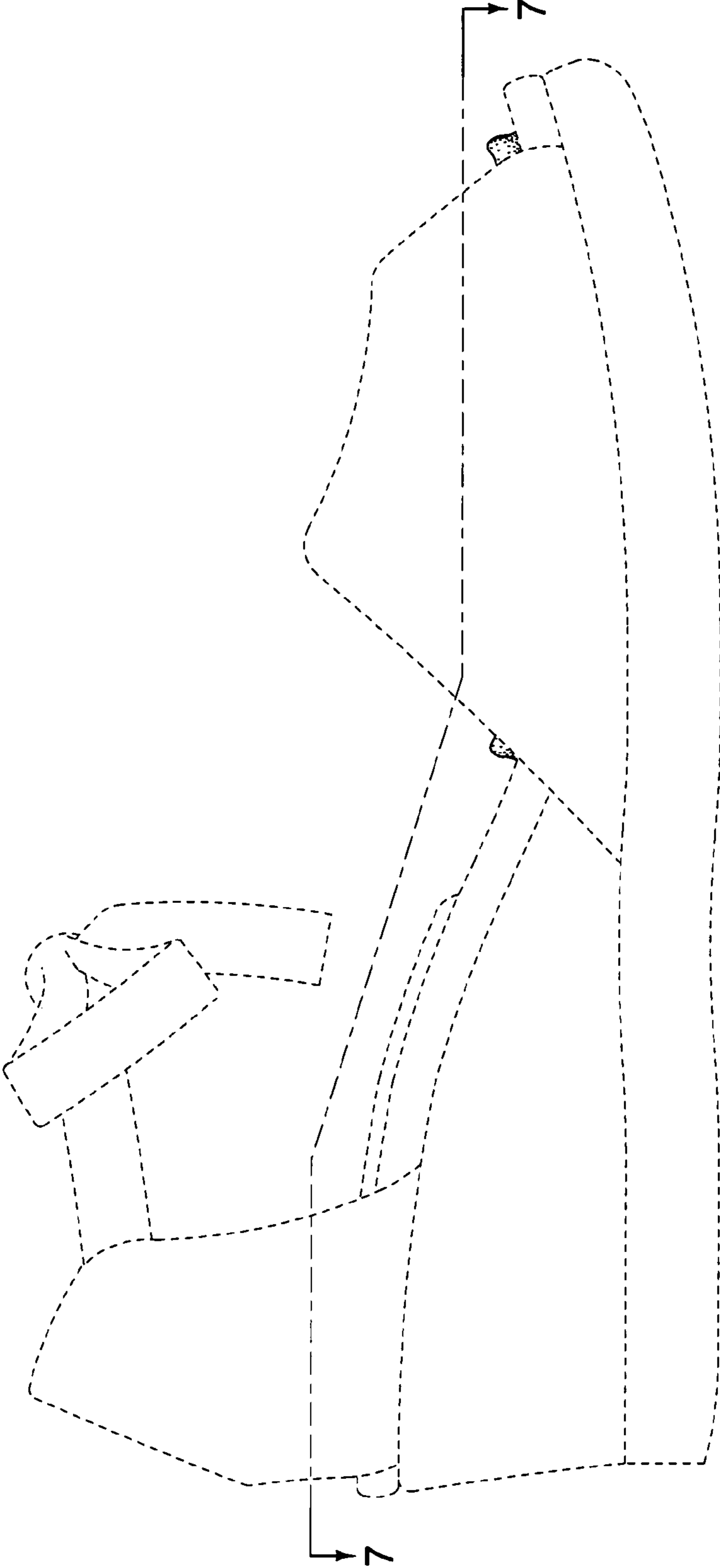

FIG. 2

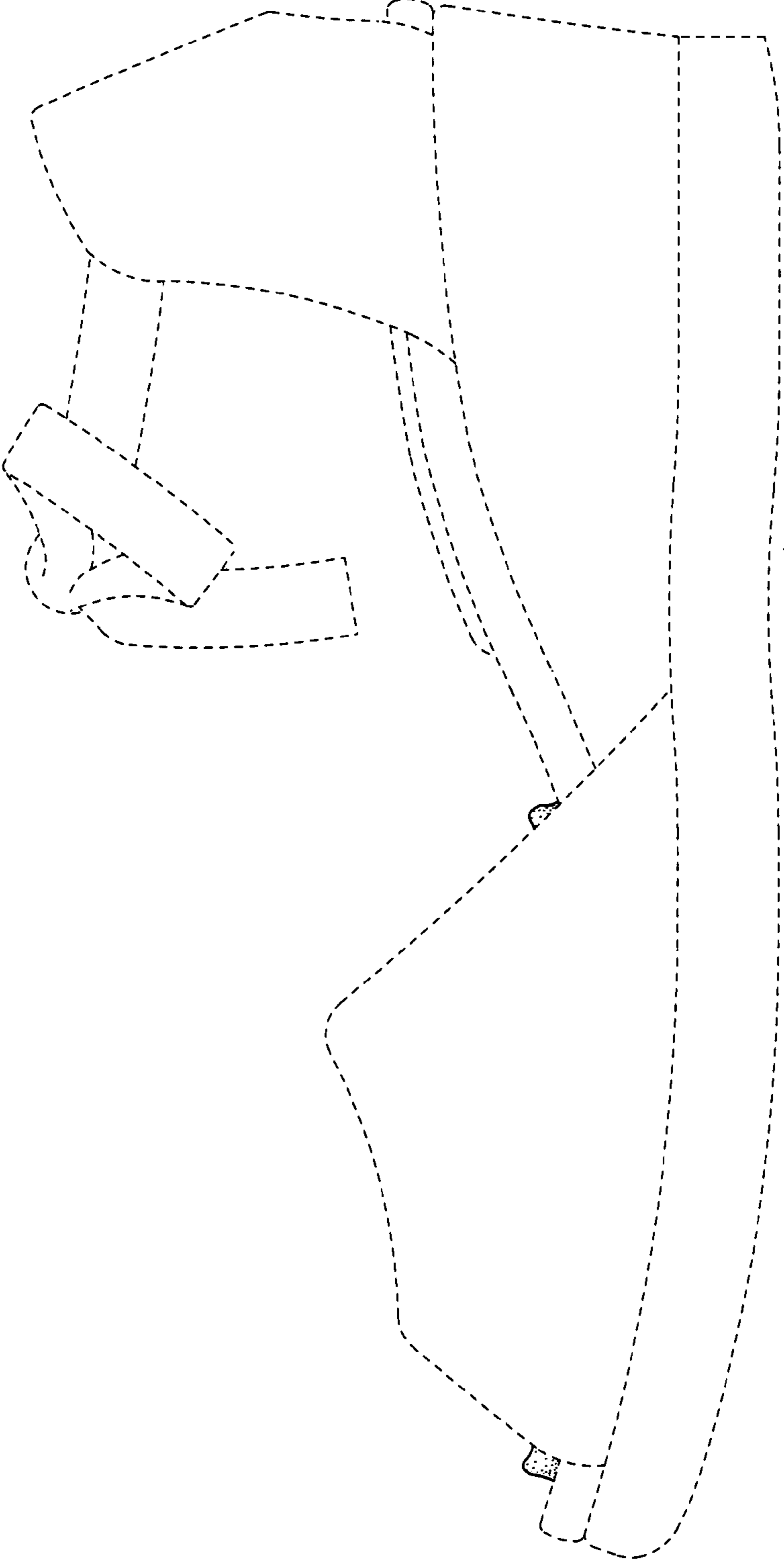

FIG. 3

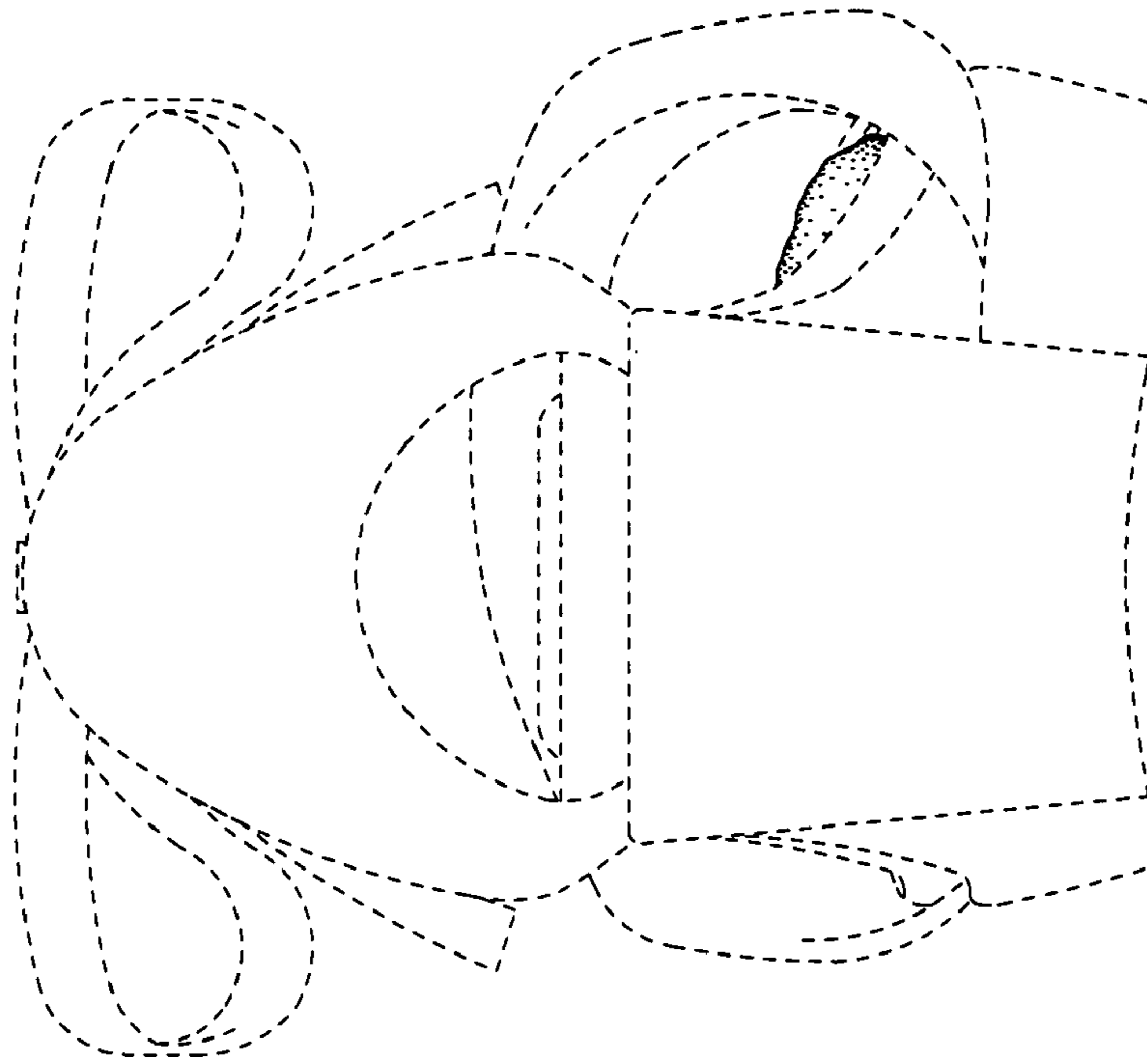

FIG. 5

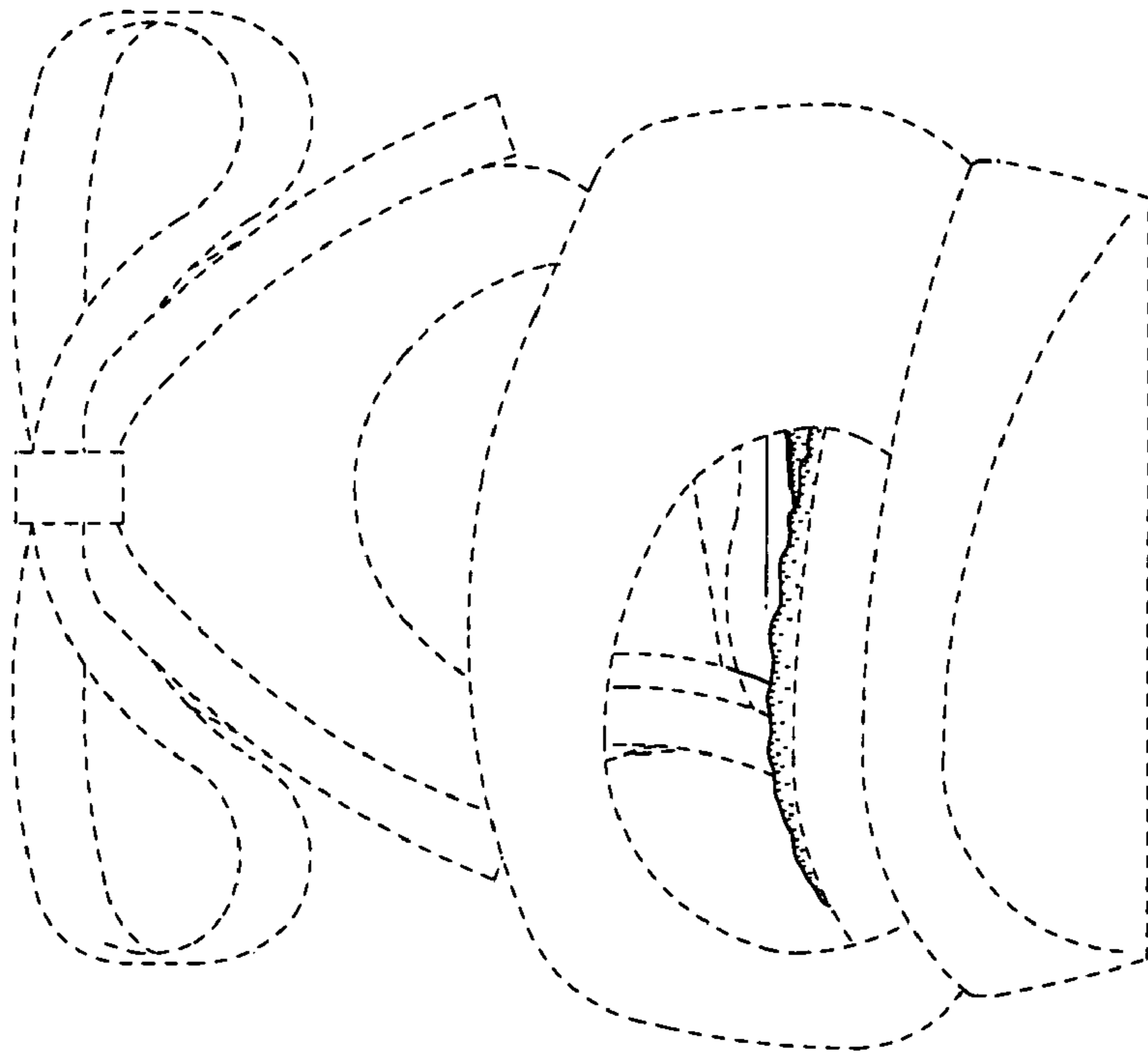

FIG. 4

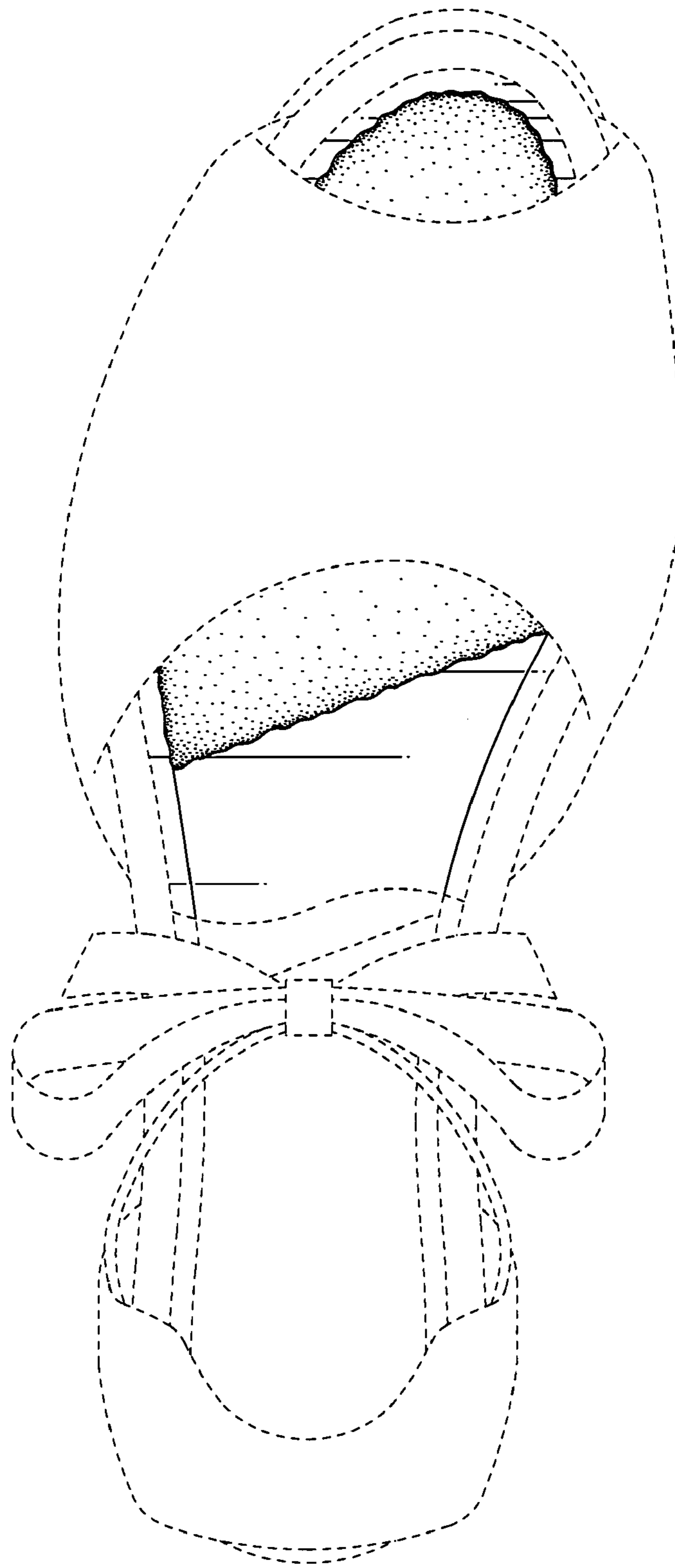

FIG. 6

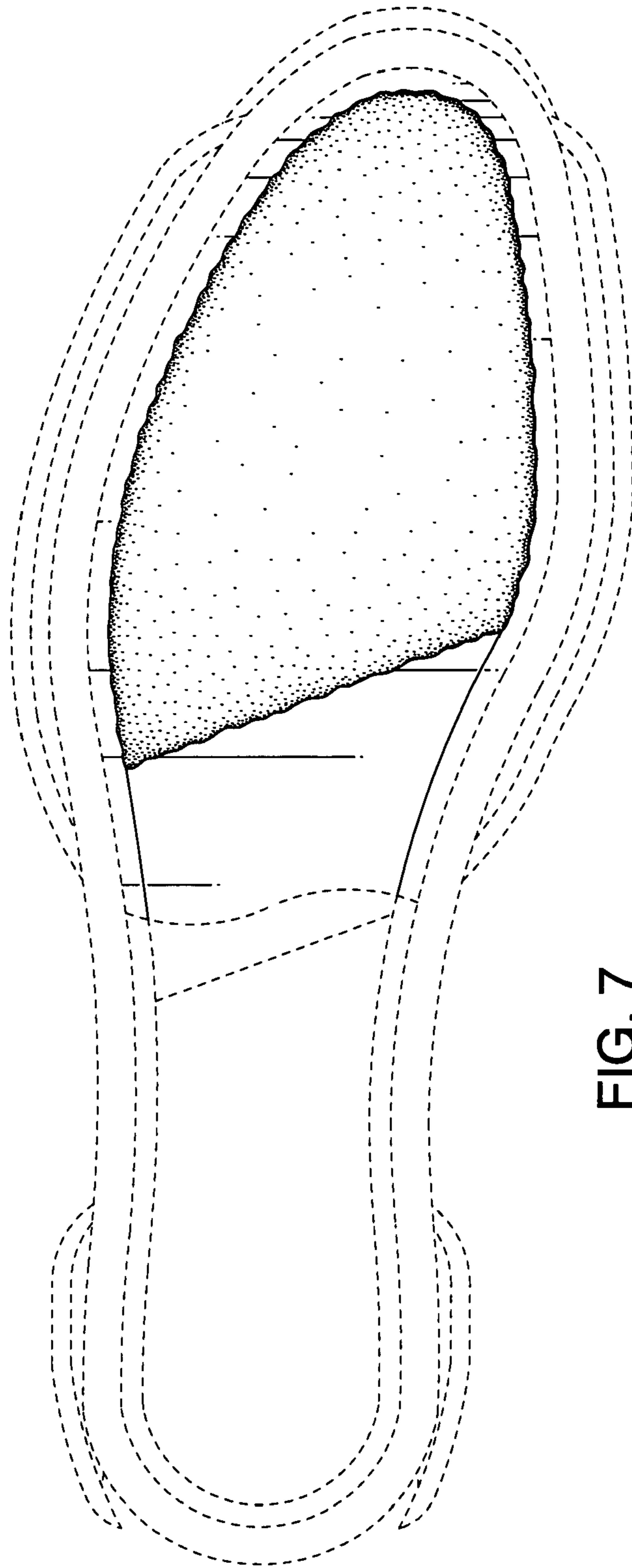

FIG. 7