



US00D622929S

(12) **United States Design Patent**  
**Anderson**

(10) **Patent No.:** **US D622,929 S**

(45) **Date of Patent:** **\*\* Sep. 7, 2010**

(54) **CONFECTION**

(75) **Inventor:** **Brent A. Anderson**, Lincoln Park, NJ  
(US)

(73) **Assignee:** **Mars, Incorporated**, McLean, VA (US)

(\*\*) **Term:** **14 Years**

(21) **Appl. No.:** **29/354,575**

(22) **Filed:** **Jan. 26, 2010**

(51) **LOC (9) Cl.** ..... **01-01**

(52) **U.S. Cl.** ..... **D1/127; D1/106**

(58) **Field of Classification Search** ..... D1/100-199;  
D30/160; D24/102, 103; D25/119-135;  
119/706-711; 426/2, 89, 92, 104, 635, 805;  
D6/588, 598; D7/628; D11/50, 133-134;  
D20/14, 24, 30; D22/131

See application file for complete search history.

(56) **References Cited**

**U.S. PATENT DOCUMENTS**

D82,327 S \* 10/1930 Kepmter ..... D7/610  
D151,871 S \* 11/1948 Carapellotti ..... D1/126  
D165,932 S \* 2/1952 Peters ..... D1/115  
D246,833 S \* 1/1978 Campbell ..... D11/125  
D264,295 S \* 5/1982 Lage et al. .... D6/303  
D275,559 S \* 9/1984 Williams ..... D11/125

D300,673 S \* 4/1989 Rhoa et al. .... D24/101  
D365,875 S \* 1/1996 Bradbury et al. .... D24/101  
D394,535 S \* 5/1998 Villota et al. .... D1/126  
D437,671 S \* 2/2001 Fajerstein ..... D1/106  
D600,380 S \* 9/2009 van der Lande ..... D26/47  
D613,476 S \* 4/2010 Lee et al. .... D1/127

\* cited by examiner

*Primary Examiner*—Jennifer Rivard

*Assistant Examiner*—Barbara Fox

(74) *Attorney, Agent, or Firm*—Arent Fox LLP

(57) **CLAIM**

The ornamental design for a confection, as shown and described.

**DESCRIPTION**

FIG. 1 is a perspective view of a confection showing my new design;

FIG. 2 is a top view of the design shown in FIG. 1;

FIG. 3 is a bottom view of the design shown in FIG. 1;

FIG. 4 is a front view of the design shown in FIG. 1, the rear view being identical thereto; and,

FIG. 5 is a left side view of the design shown in FIG. 1, the right side view being identical thereto.

**1 Claim, 5 Drawing Sheets**

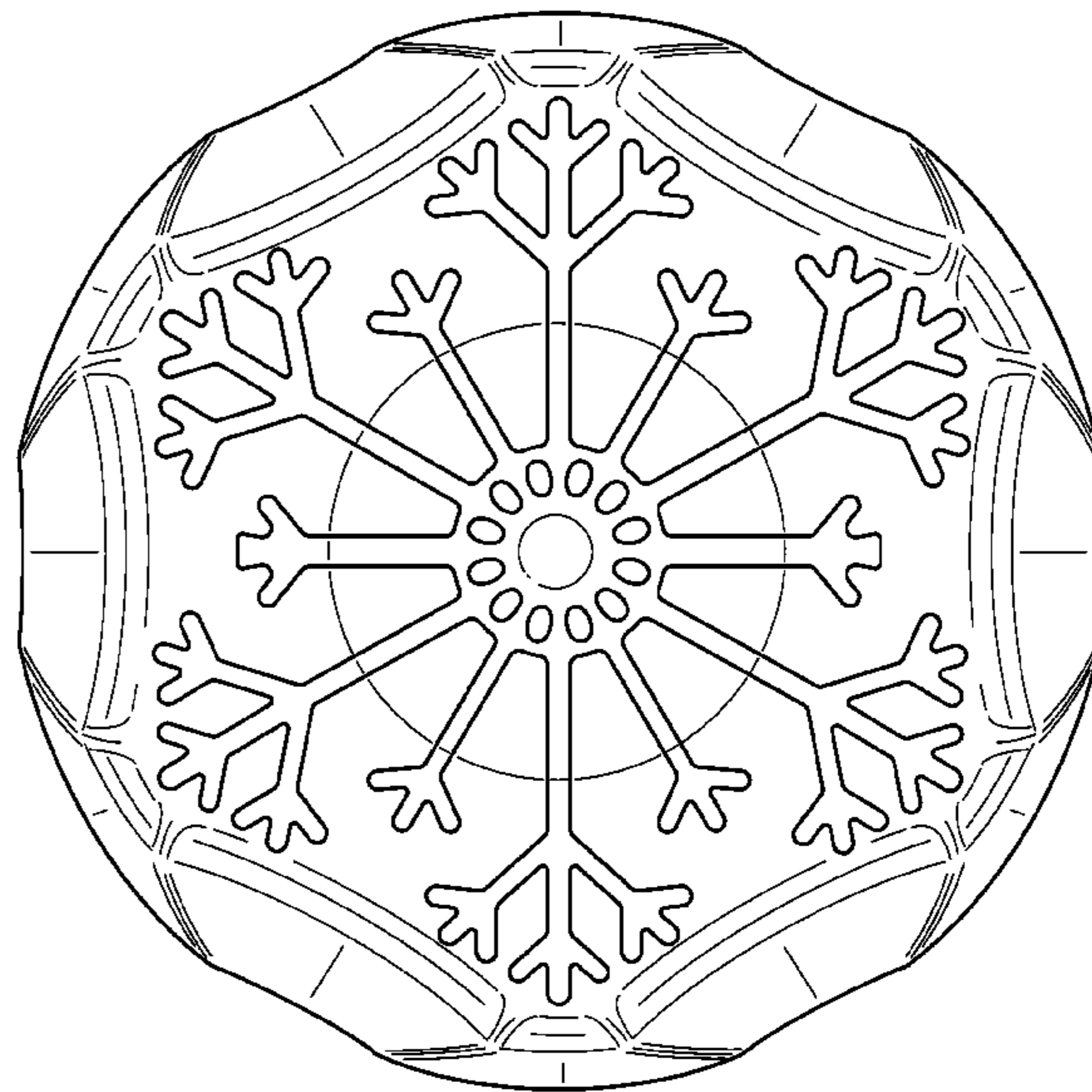
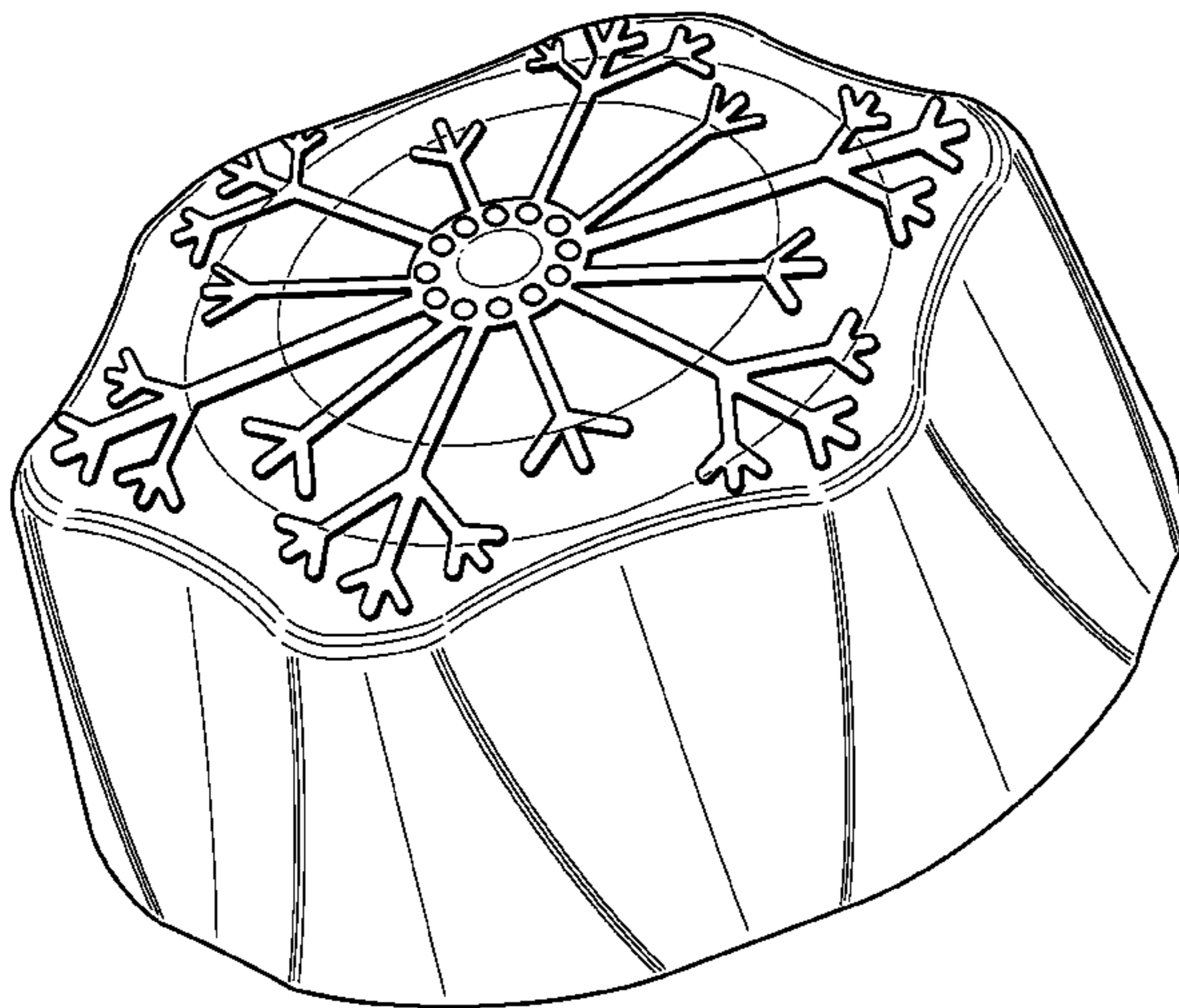

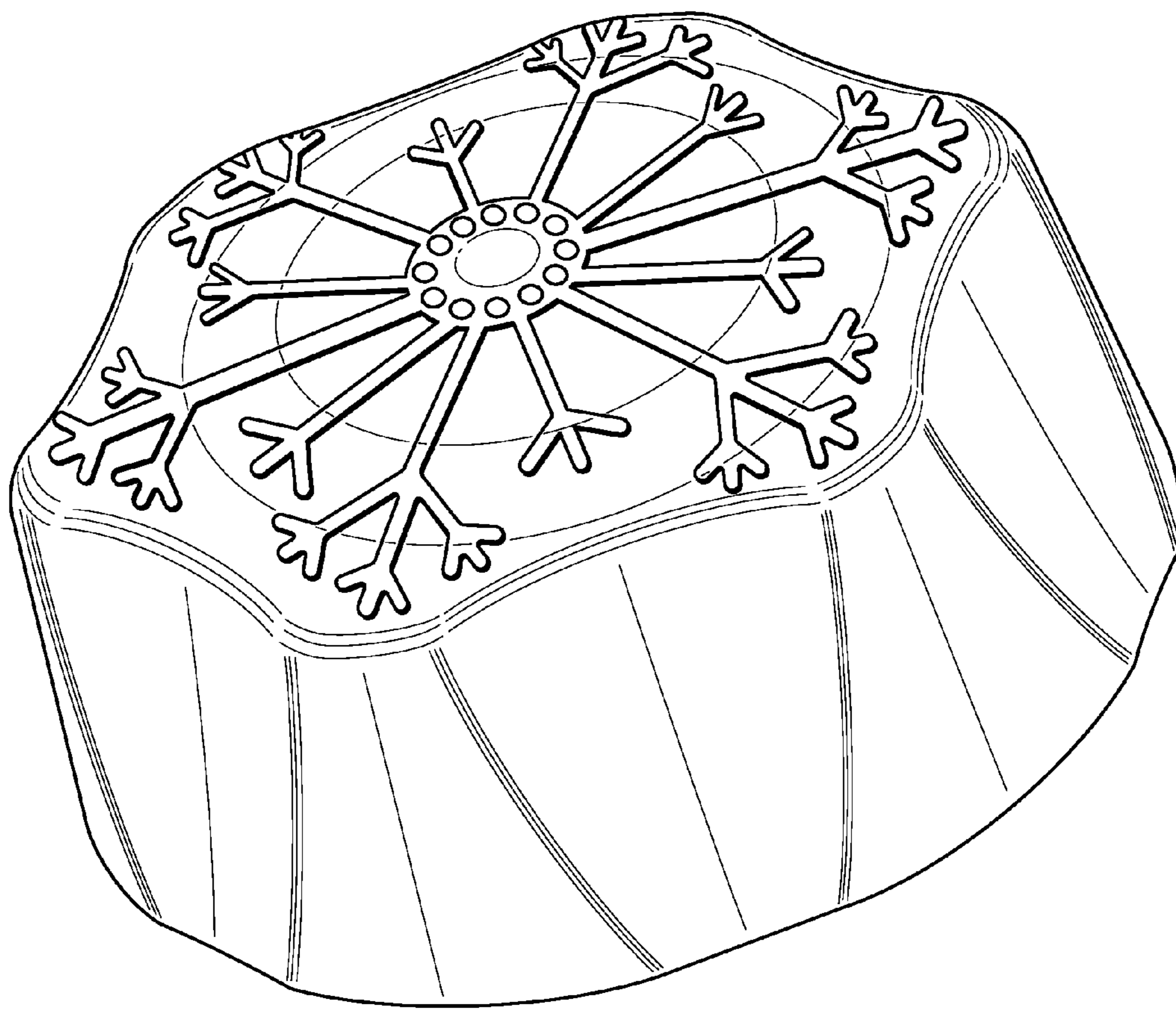

FIG.1

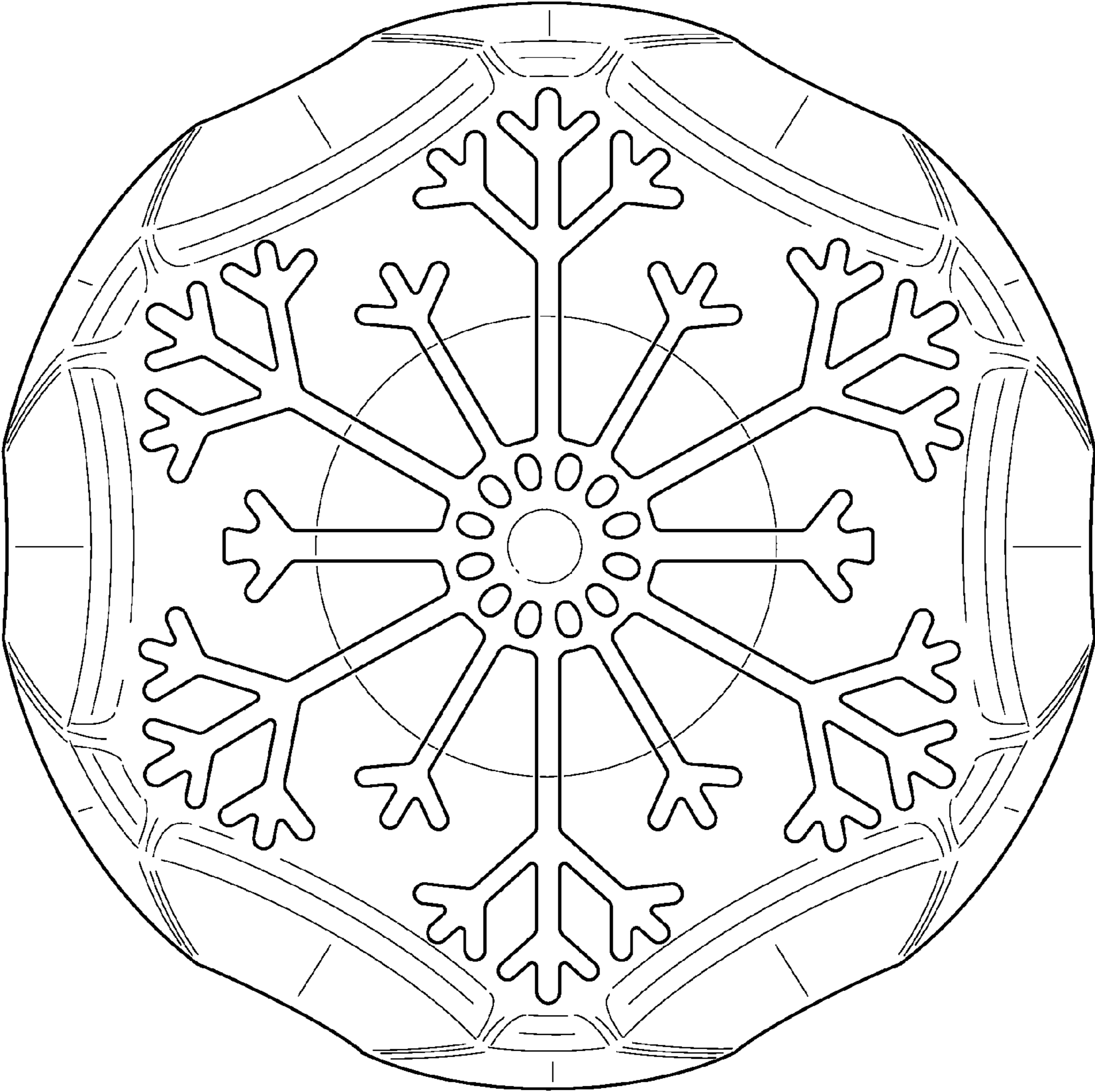

FIG.2

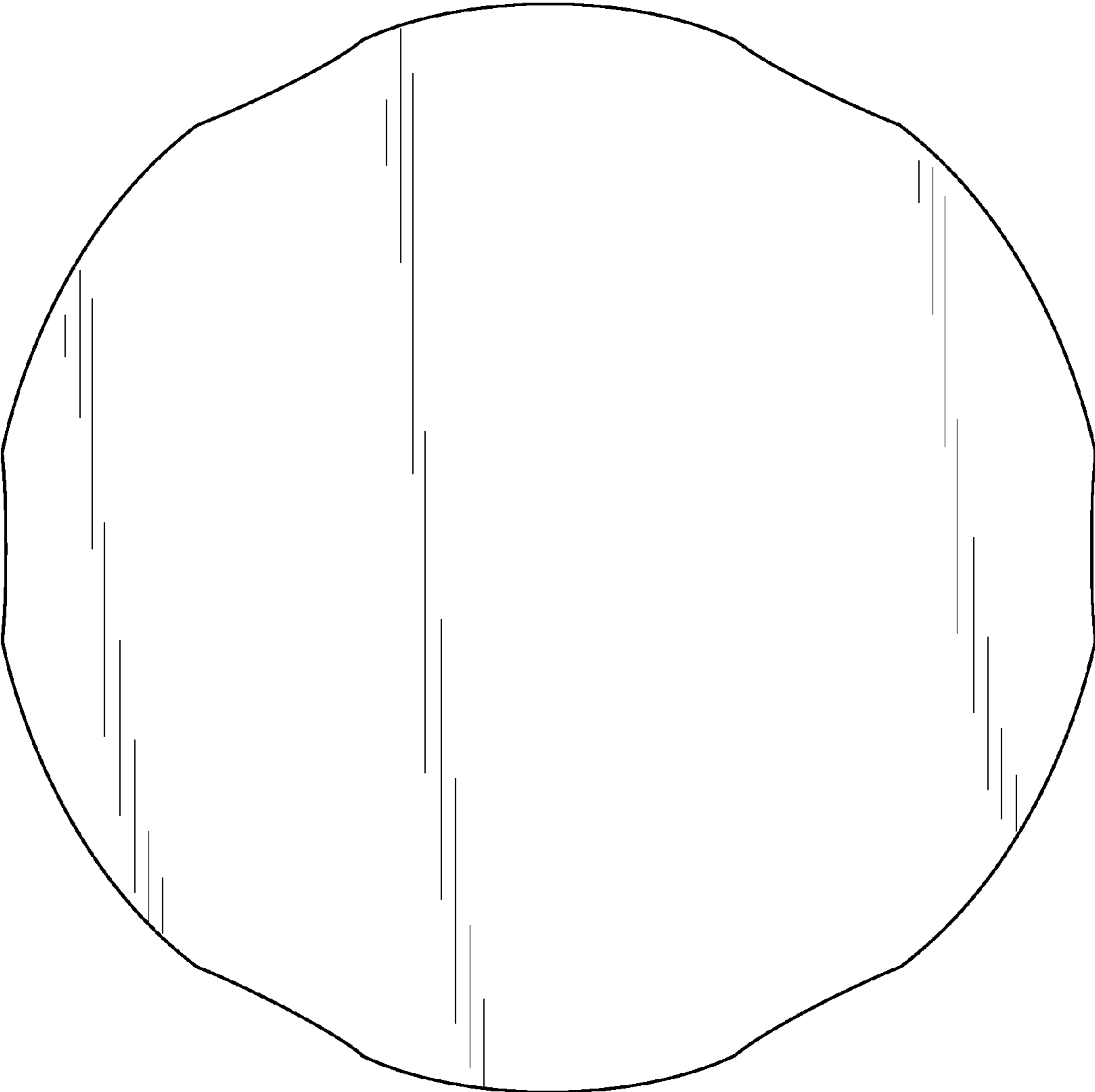

FIG.3

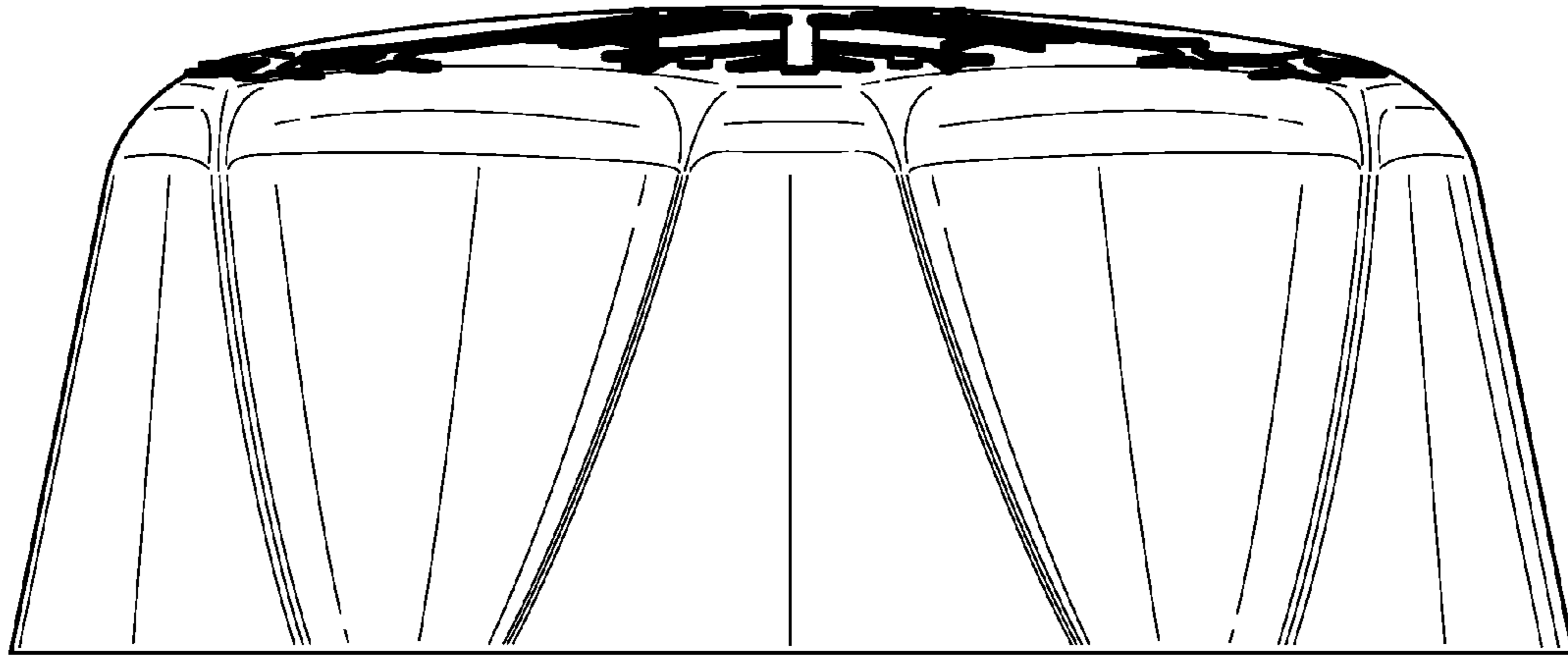

FIG.4

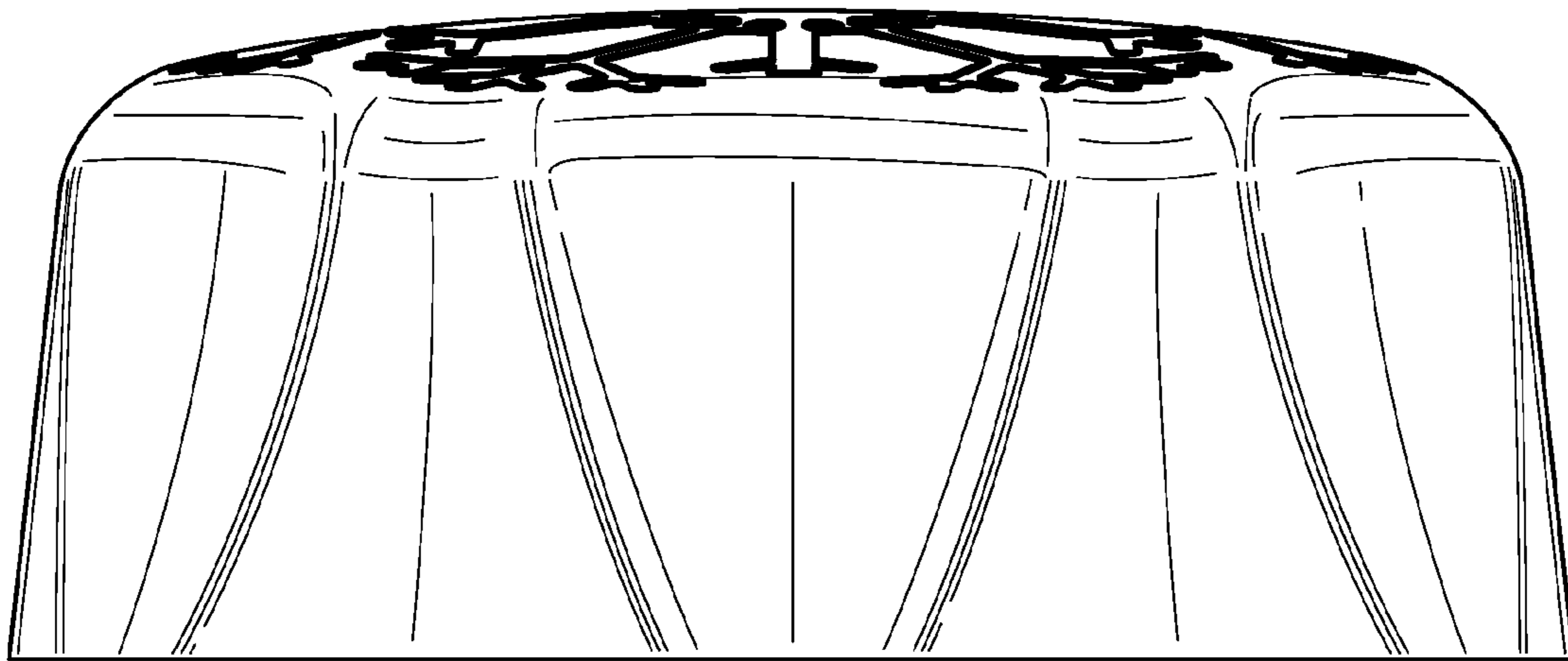

FIG.5